

# Womanizer

THE ORIGINAL

## OG



MANUAL / MODE D'EMPLOI / BEDIENUNGSANLEITUNG  
MANUAL DE INSTRUCCIONES / GEBRUIKSAANWIJZING  
NÁVOD K OBSLUZE / ИНСТРУКЦИЯ ПО ЭКСПЛУАТАЦИИ  
INSTRUKCJA OBSŁUGI / BRUKSANVISNING / MANUAL DE OPERAÇÃO  
ISTRUZIONI PER L'USO / BRUGSANVISNING / BRUKSANVISNING  
操作说明 / 사용 설명서 / 快速入门用户指南 / 取扱説明書 / MANUAL /  
KASUTUSJUHEND / KÄYTTÖOHJE / HASZNÁLATI ÚTMUTATÓ  
VADOVAS / LIETOŠANAS INSTRUKCIJA / ПРИРАЧНИК /  
NÁVOD NA POUŽITIE / KULLANMA KILAVUZU

# Languages

ENGLISH

한국어

FRANÇAIS

繁体字

DEUTSCH

日本語

ESPAÑOL

SHQIP

NEDERLANDS

БЪЛГАРСКИ

ČEŠTINA

EESTI KEEL

РУССКИЙ

SUOMI

POLSKI

MAGYAR

SVENSKA

LIETUVIŲ KALBA

PORTUGUÊS

LATVIEŠU VALODA

ITALIANO

МАКЕДОНСКИ

DANSK

SLOVENČINA

NORSK

TÜRKÇE

中文(简)

# Hi!

Thank you for choosing **WOMANIZER OG!**

Welcome to a world full of sensual experiences that will enrich your life.

By choosing **WOMANIZER**, you are not only guaranteed orgasms that are beyond comparison – but also an entirely new lust for pleasure.

Enjoy your **OG** one orgasm after another.

Go, love yourself!



PRODUCT DESCRIPTION

HOW TO USE

SMART SILENCE

CLEANING

CHARGING

SOME SNEAKY DETAILS

SAFETY INSTRUCTIONS

GENERAL INFORMATION

Please read the safety instructions in the  
Compliance & Safety Information before first use.

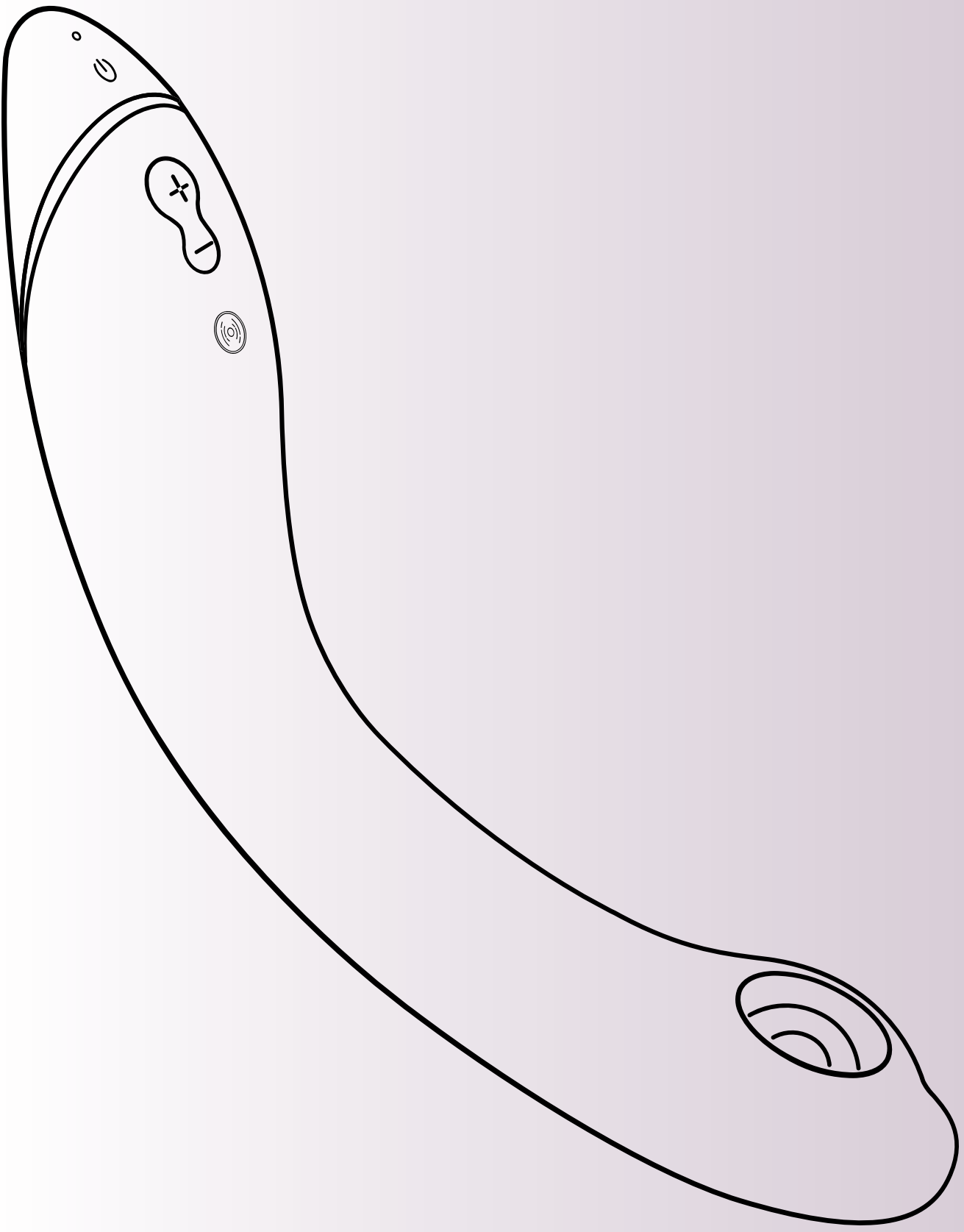

# PRODUCT DESCRIPTION

**LED Display**  
On / Charging

**Smart Silence**  
On / Off  
Press for 2 seconds

**Vibration**  
Press briefly  
to activate and  
increase intensity  
(3 levels)

**Pleasure Air Technology**  
(12 intensity levels)

**On / Off**  
Press for 2 seconds

**Increase Intensity**  
Press (+) briefly

**Decrease Intensity**  
Press (-) briefly

**Afterglow**  
Press (-) for 1 second



# HOW TO USE

## 1. Turn on

Press for 2 seconds.  
The LED will indicate  
that the product is  
turned on.

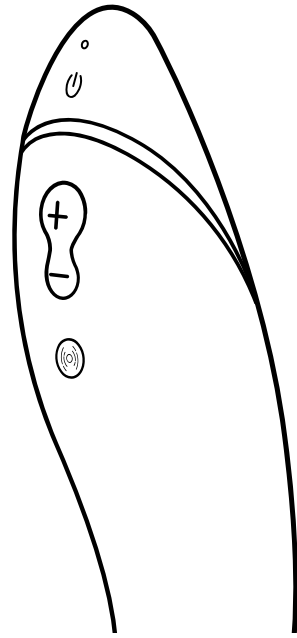

## 2. Usage

To get in the mood,  
use **OG** on your clitoris first.

Add water-based lube  
to **OG's** body.

Once you are warmed up,  
insert **OG** and explore your G-Spot!

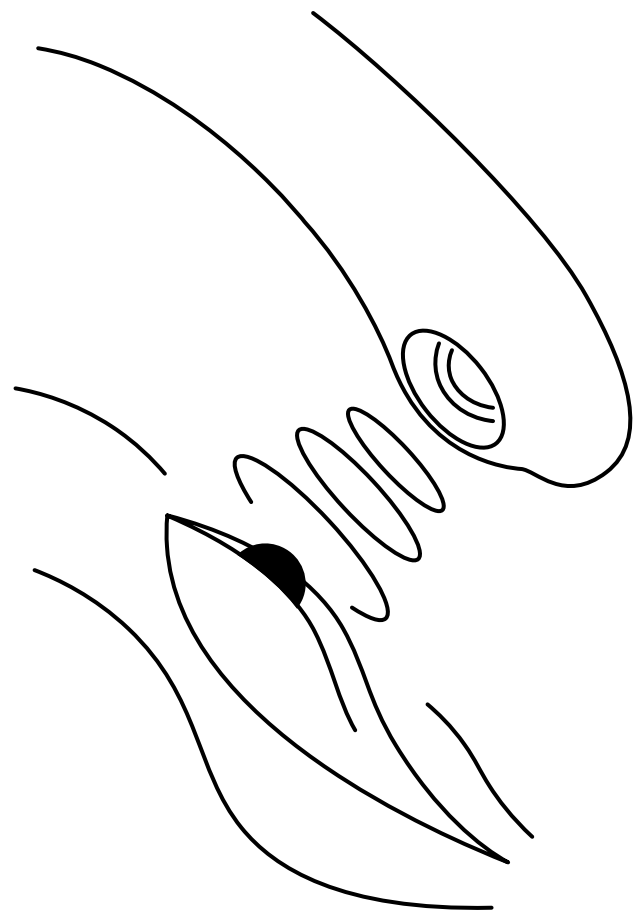

# HOW TO USE

## 3. Change Intensity

**Increase** •  
Press briefly  
**12 Intensity levels**

**Increase** •  
Press briefly  
**3 Vibration levels**

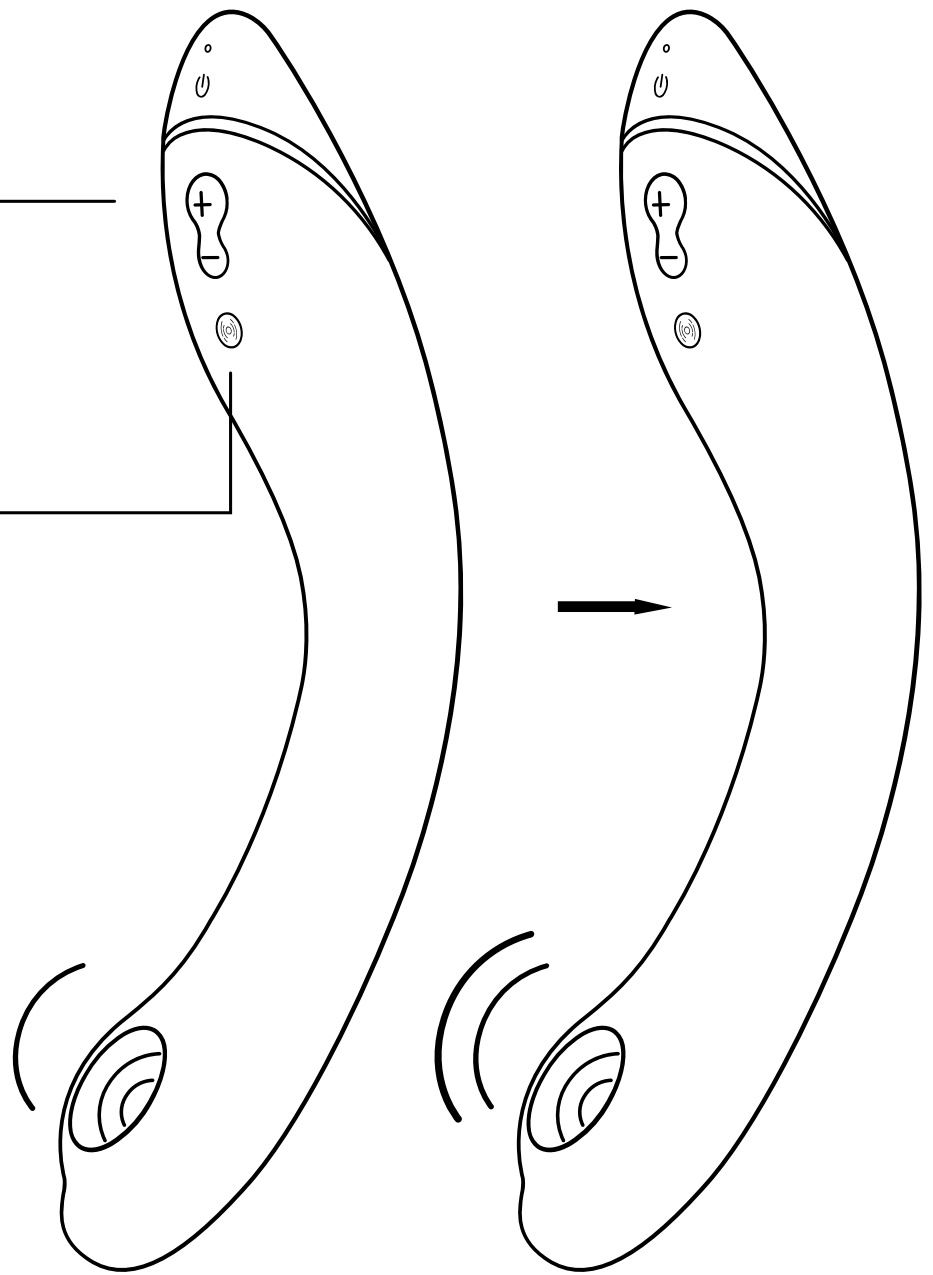

**Decrease** •  
Press briefly

**Afterglow**  
Press (-) for  
1 second to fall back  
to Intensity level 1

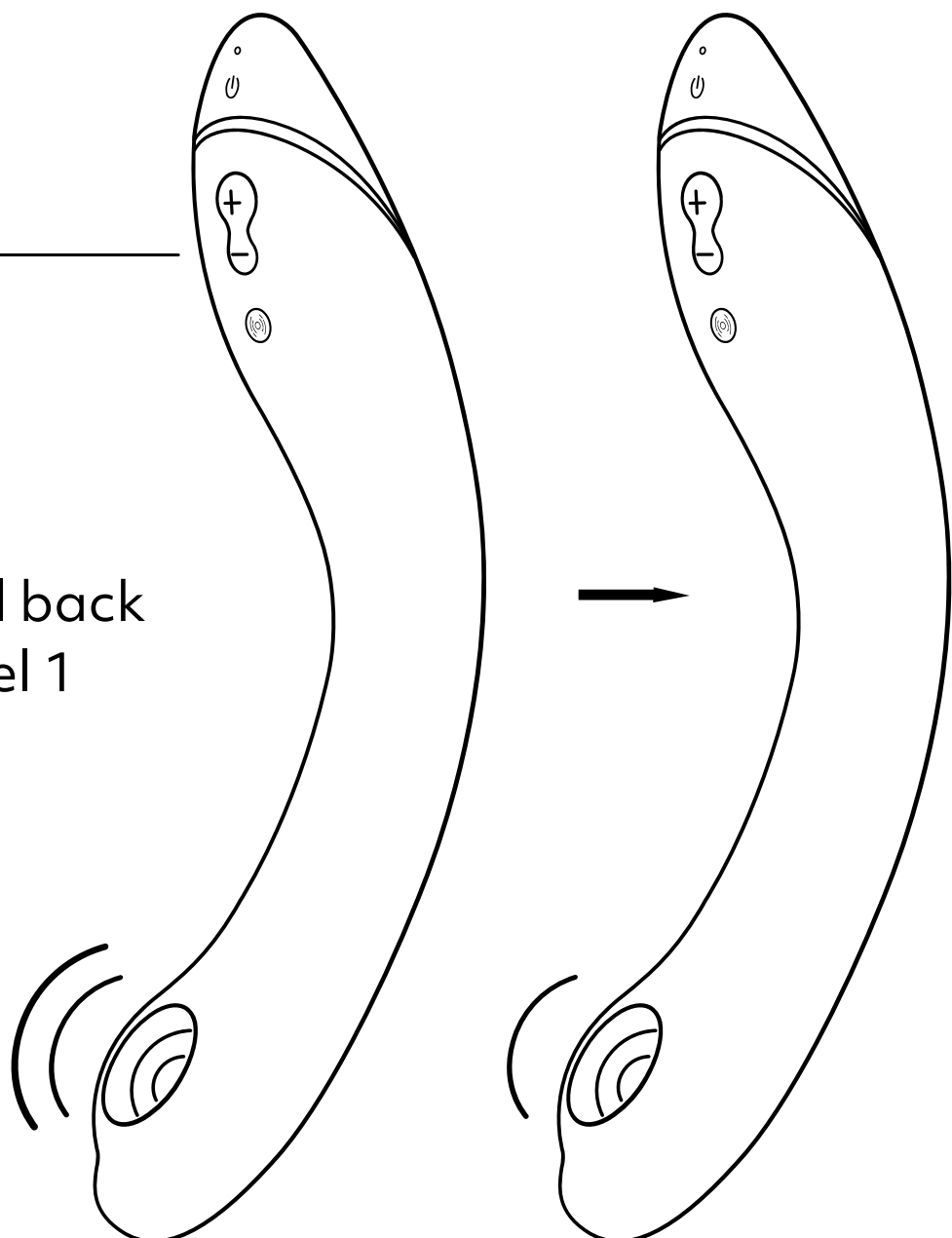



# HOW TO USE

## 4. Turn off

Press for 2 seconds

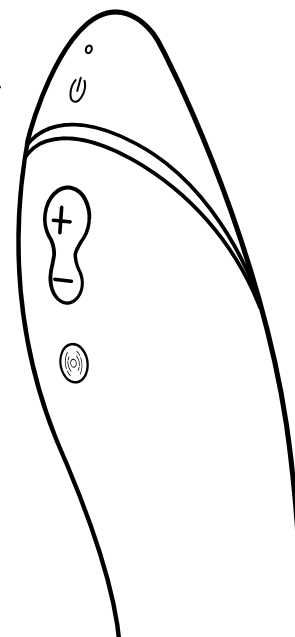

## SMART SILENCE

**OG** only turns on when it's almost touching your skin.  
Smart Silence will be turned on by default.  
Press and hold the plus and minus buttons for 2 seconds  
to turn Smart Silence on or off.

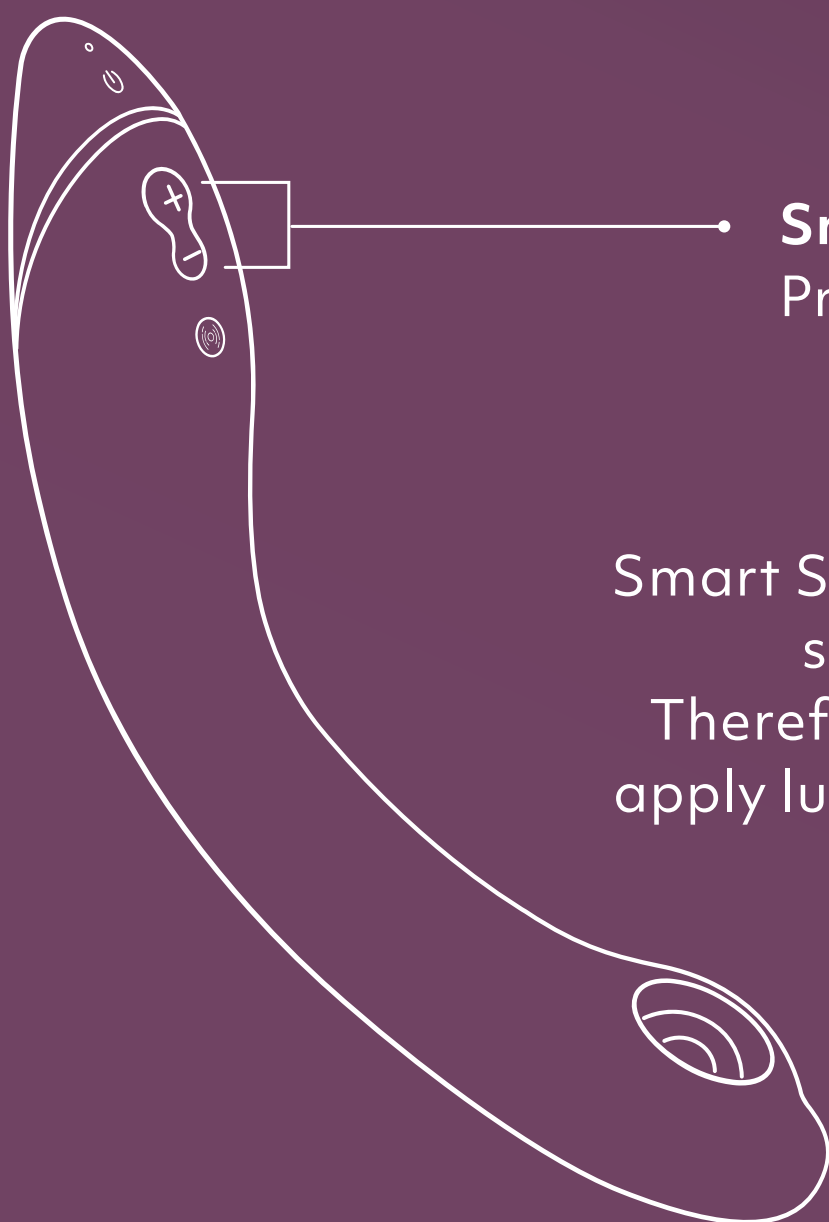

### Smart Silence On / Off

Press for 2 seconds.

Smart Silence may not work when the stimulation head is wet.  
Therefore, please make sure not to apply lube into the Pleasure Air head.

# CLEANING

Wash under water.

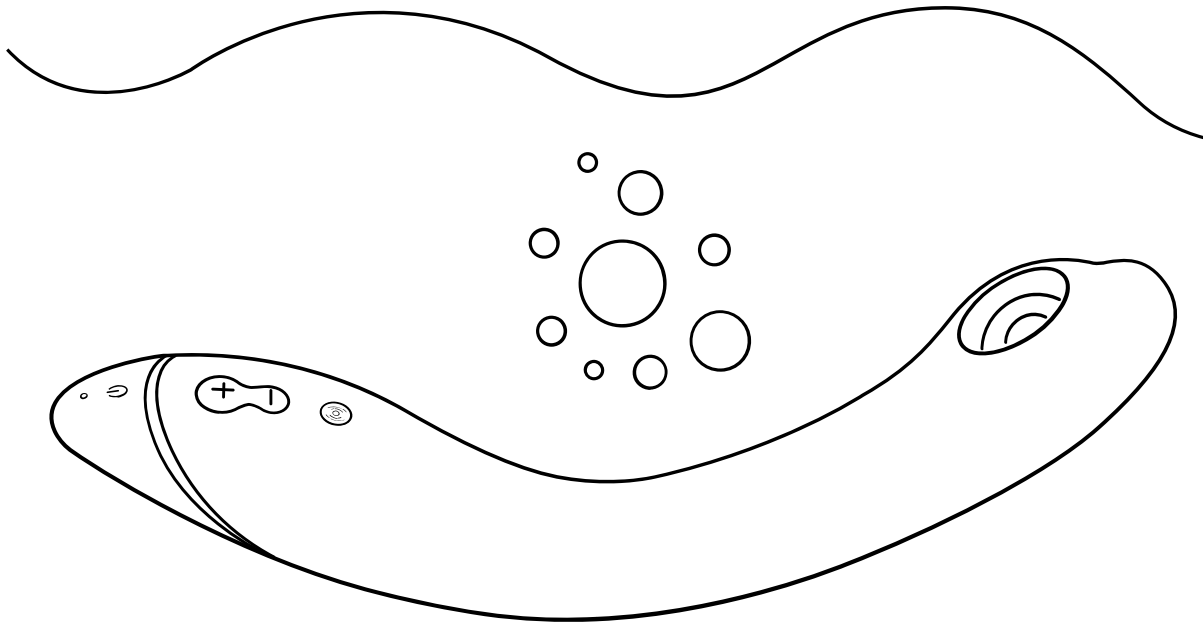

Apply toy cleaner.

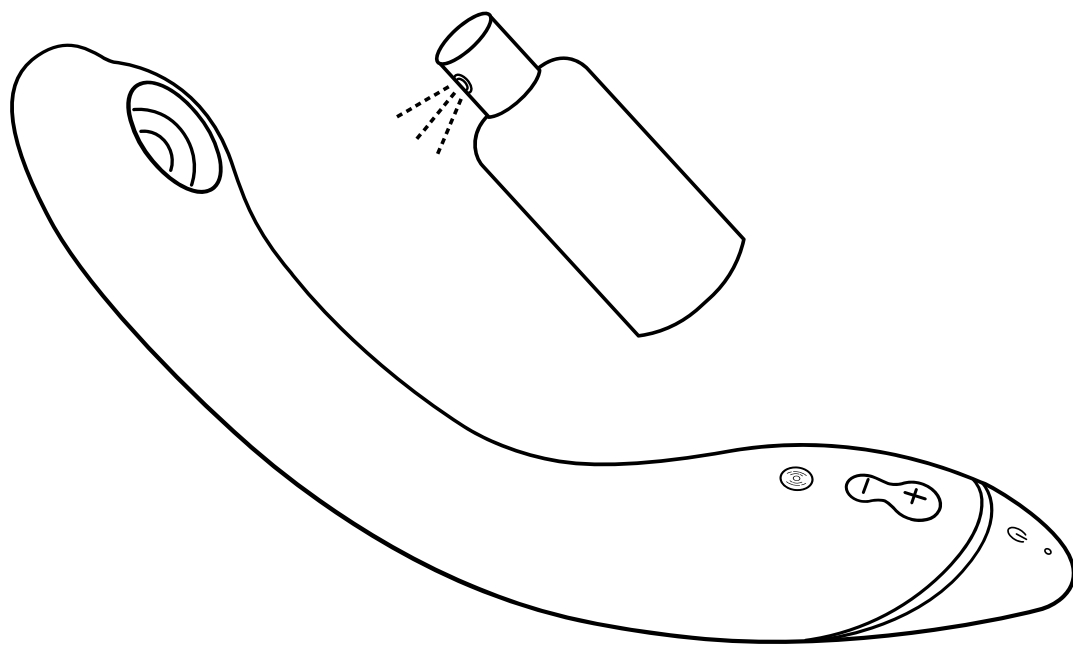

Dry carefully without applying too much pressure to the membrane.

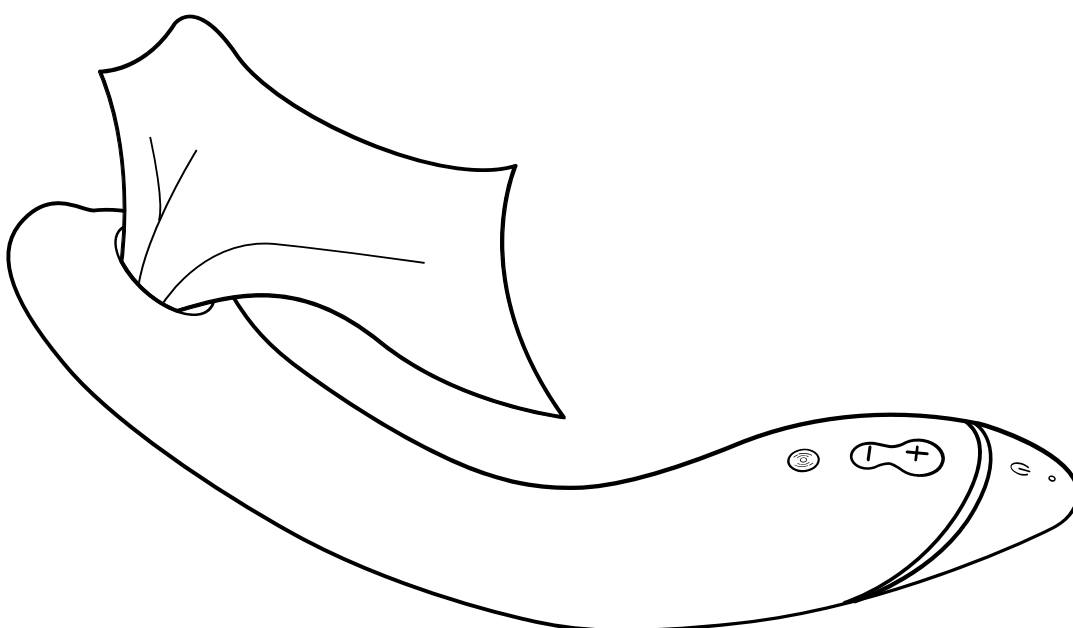

Waterproof  
(IPX7)

# CHARGING

Please charge your **OG** before first use.  
Also keep in mind to recharge your **OG** regularly,  
to ensure a long battery life.

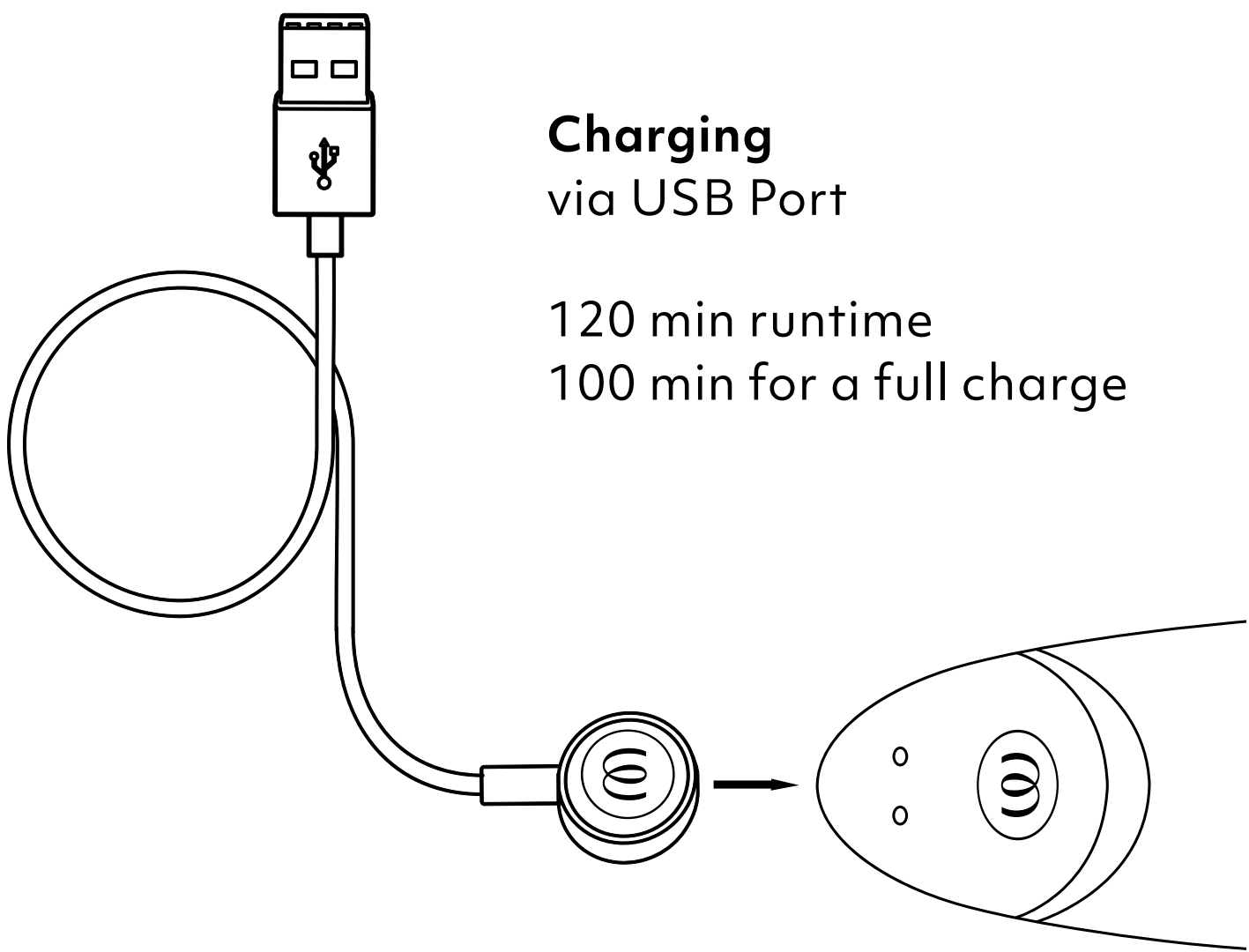

**Charging**  
via USB Port

120 min runtime  
100 min for a full charge

---

## LED

On / Off / Charging

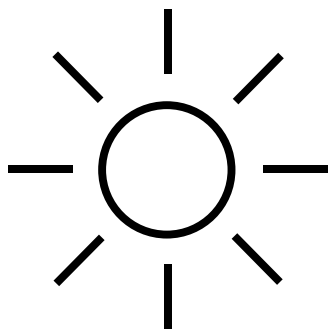

**Fully charged**  
LED lights up continuously

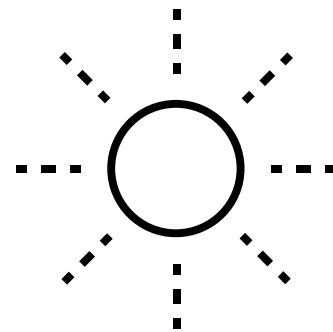

**Charging**  
LED flashes

# SOME SNEAKY DETAILS

about how to thrive with **WOMANIZER OG**

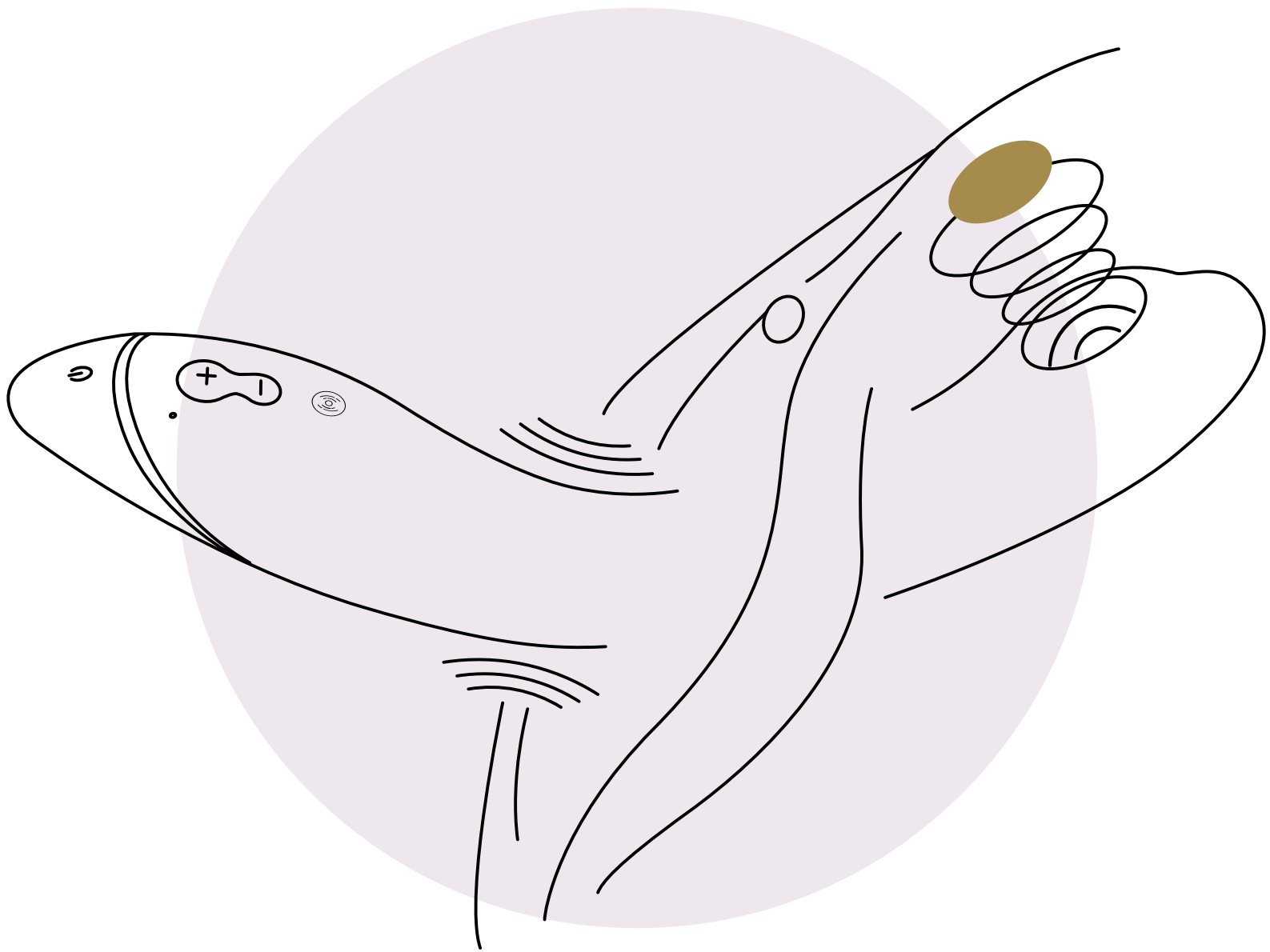

The “G” in **G-Spot** is named after physician Ernst Gräfenberg. While the name has stuck, today we know that the G-Spot is not so much a “spot” but rather a larger area of the inner clitoris, which can be stimulated from inside the vagina.

The G-Spot area is covered by the front vaginal wall making it **less sensitive than the exposed outer clitoris**.

As it’s covered, the G-Spot takes more time to warm up. **It gets bigger, more sensitive, and more receptive to stimulation with arousal.**

A G-Spot orgasm is a truly special, unique experience, and can take a little time and care to achieve — and it’s worth it! The resulting climax is so satisfying and **totally different from anything you’ve experienced.**

# THE JOURNEY

Take your time and stay curious.

Add water-based lube to **WOMANIZER OG's** body.

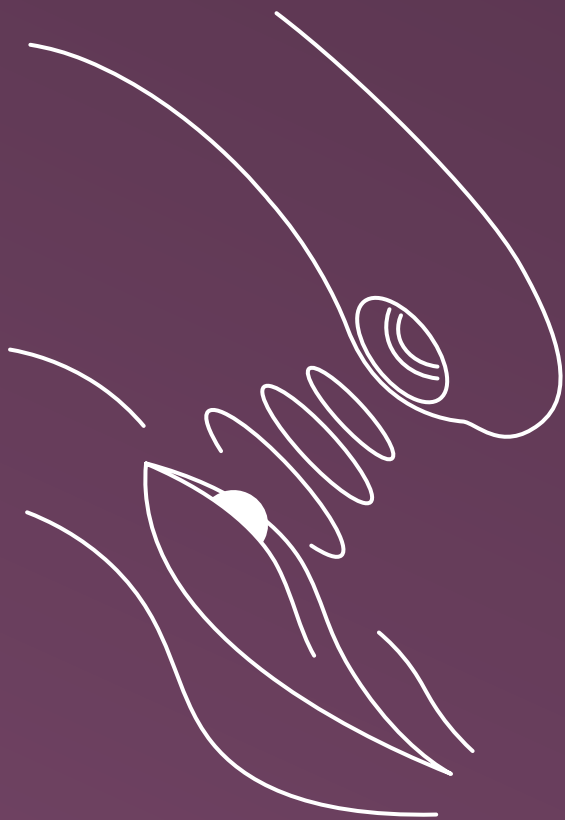

Get in the mood  
Start your journey with **WOMANIZER OG** with external **Pleasure Air stimulation** on your clitoris.

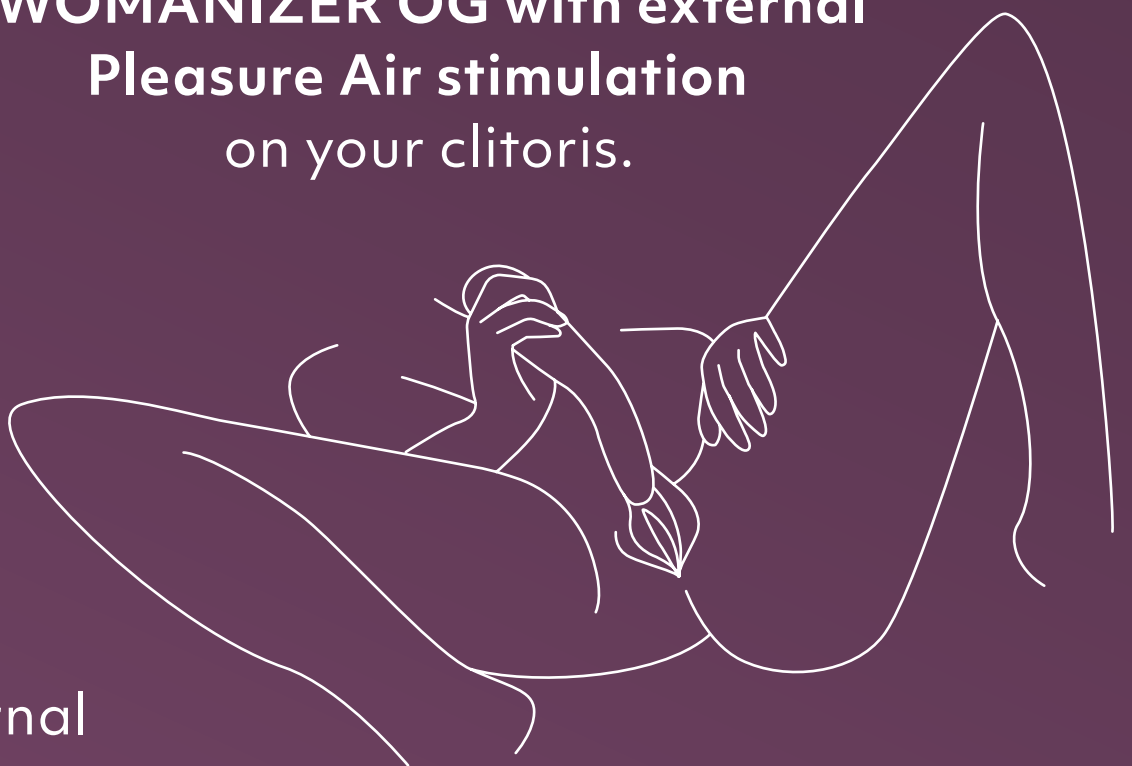

Then follow with internal **Pleasure Air stimulation**, combined with vibrations.



**OG** offers a combination of **Pleasure Air stimulation** and powerful vibrations.

Try out different intensities and vibration modes to create your unique orgasmic journey.

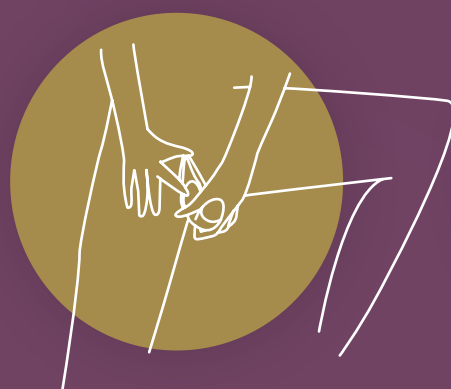
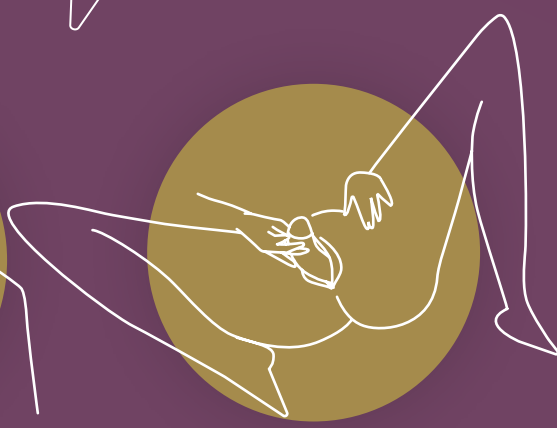
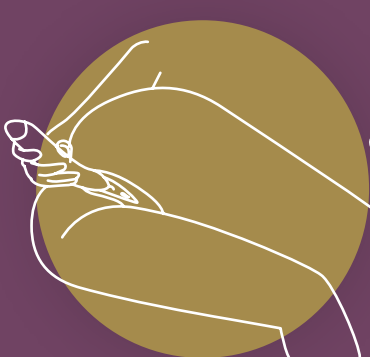

# SAFETY INSTRUCTIONS

## WARNING

Sold as a novelty product only. Not suitable for medical purposes. Only use the product for the intended purpose. Keep out of reach of children. If you are under a physician's care and/or have a condition requiring the use of any medical device, please consult your physician before using this product. Stop using the product immediately if you experience any skin irritations, pain or discomfort and consult your physician.

This product can be used by adults only. Persons with reduced physical, sensory or mental capabilities or lack of experience and knowledge if they have been given supervision or instruction concerning use of the product in a safe way and understand the hazards involved. Children shall not play with the product. Cleaning and user maintenance shall not be done by children. Do not use on swollen or inflamed areas of skin.

- Remove piercings or jewellery in the genital area before use.
- Always clean the product before and after use according to the instructions given in the manual.
- To avoid damage to the product, the product and its battery must not be exposed to temperatures above 45°C, be dismantled or mechanically or electrically damaged.
- Sharing sex toys may transmit sexual diseases. Do not share your sex toys with users other than your partner. Use protective measures with your partner if necessary. Do not use the toy if you detect any cracks or signs of degradation in the cover material.
- This product is not designed for anal use. Do not use anally!
- To prevent stains, do not place the soft side of your product on an absorbent surface.
- Check the charging device and the product regularly for damage and do not use in any case of damage.
- Magnetic fields can influence mechanical and electronic components such as pacemakers. Do not use the product directly over a pacemaker. Contact your physician for more information.
- Keep cards with magnetic stripes (such as credit cards) away from the product, as they may be damaged by the product's magnet.
- If your product appears to be functioning abnormally, turn it off and consult the support section on our website.

## CHARGING

- Before the first use of the charging device, check the local voltage level, since the local mains voltage may not exceed the maximum mains voltage given on the charging device.
- The product must only be charged at an appropriate, extra-low voltage corresponding to the marking on the product.
- Do not use or clean the product while the battery is charging.
- Never immerse the charging device or charging cable in water or other fluids.
- This product contains batteries that are non-replaceable.
- This product contains a rechargeable Li-ion battery.
- Disconnect the charging cable from the electrical supply each time after the product has been charged.

## FOR OPTIMAL USE OF THE PRODUCT, PLEASE FOLLOW THE FOLLOWING GUIDELINES:

- To guarantee a long battery life, please charge the product regularly, even if not in use.
- Store in a secure, dry place without exposure to direct sunlight.
- We recommend using a water-based lubricant with your product. To prevent damage to the product, do not use perfumed, alcohol-based lubricants, gels or massage oils with the product. Do not use silicone-based lubricants with silicone products.

## NOTE ON BATTERIES

European regulations require that we provide the following information:

- Batteries and rechargeable batteries must not be disposed of in household waste. As an end user, you are legally required to return used batteries. Please use official collection facilities such as the collection points provided by public waste management authorities to do so. You can also return used batteries that we carry or have carried as new batteries to us. Please contact us at

care@womanizer.com. To prevent short circuits, the poles of lithium batteries should be taped before returning. For safety reasons, we ask you not to send the batteries to us by mail and refer you to the regulations for sending hazardous goods provided by mail carriers.

- If the batteries are permanently installed in the product, please do not try to remove them yourself. This may cause permanent damage to the device. Your obligations as a customer are otherwise regulated by the WEEE Directive and the national implementation law.
- Please observe the information in the manual and the safety instructions to prevent waste and littering.
- Used batteries contain harmful substances that can damage the environment or your health if they are not stored or disposed of properly. In particular, this applies to the improper handling of lithium batteries. Batteries also contain important raw materials such as iron, zinc, manganese and nickel and can be recycled. Separate collection allows these raw materials to be recycled and prevents negative impacts on the environment and human health from released pollutants.
- The sign with the crossed-out waste bin means that you must not dispose of batteries and accumulators with household waste.



If the legal requirements are present, this sign means that the following symbols and their meaning must be used when labeling the batteries:

- Hg: Battery contains more than 0.0005 percent mercury by mass
- Pb: Battery contains more than 0.004 percent lead by mass
- Cd: Battery contains more than 0.002 percent cadmium by mass

## NOTES ON THE DISPOSAL OF ELECTRICAL EQUIPMENT

European regulations require that we provide the following information:

- We would like to point out to owners of electrical equipment that old electrical equipment must be collected separately from municipal waste in accordance with applicable legal regulations. Batteries and accumulators that are not firmly encased in the old electrical equipment, as well as bulbs that can be removed from the equipment without being destroyed, must be separated from the old equipment in a non-destructive way before being given to a collection point for proper disposal. Please refer to the separate instructions for the disposal of batteries. The symbol of a crossed-out waste bin shown below and affixed to old electrical equipment also indicates that the equipment must be collected separately:



- According to the WEEE Directive and the national implementation law, as distributors of electrical equipment, we are required to take back certain waste electrical equipment free of charge.
- When you purchase a new electrical and electronic device, you can surrender an old electrical device that essentially performs the same functions as the new device to us free of charge. If your old electrical equipment is not larger than 25 centimeters in any dimension, you can also surrender it to us free of charge without purchasing a new device. Please contact us at care@womanizer.com. We will then arrange the return of the old electrical equipment. For safety reasons, we would like to ask you to refrain from shipping lighting equipment (such as bulbs). Please use the collection points provided by public waste management authorities to return lighting equipment or contact us directly at the aforementioned e-mail address.
- You can also return old electrical equipment to any of the collection points run by the public waste disposal authorities. You are making an important contribution to the reuse, recycling and other recovery of old appliances by sending your old electrical equipment for separate collection in the proper collection groups.
- As the end user, you are responsible for deleting personal data from the used electrical equipment before handing it in for disposal.
- Please observe the information in the manual and safety instructions to prevent waste, and please check for possible repair options.
- Please observe the information in the manual and safety instructions to prevent waste, and please check for possible repair options.



# GENERAL INFORMATION

## ELECTRICAL RATING

**Model:** OG

**Model No.:** TES10A

**Power Input:**

3,7 V=0,62 A: Built-in Li-Polymer rechargeable battery.

5 V=0,5 A: When charged using USB.

Use USB AC adaptor (not included) with power output corresponding to product rating. Use original provided cable only."

## CONTENT OF DELIVERY

Womanizer OG G-Spot vibrator, USB charging cable (AC adapter not included), cotton storage pouch, quick start guide, safety instructions

## ENVIRONMENTAL PROTECTION

As a distributor of electronic devices, we are legally obliged to accept the return of waste electrical and electronic devices free of charge. We expressly state that you as the user are legally obliged to return used batteries.

Never throw away electronic devices or batteries in the household waste. The symbol shown below (crossed-out wheeled bin) is intended to expressly remind you of this.

## MANUFACTURED AND DISTRIBUTED BY

**WOW Tech Europe GmbH**

Hermann-Blankenstein-Strasse 5

10249 Berlin

[www.wowtech.com](http://www.wowtech.com)

WOW Tech Europe GmbH reserves the right to make technical changes and changes to the design that serve to improve the device.

For information regarding patents see [womanizer.com/patents](http://womanizer.com/patents).

## CUSTOMER CARE

[care@womanizer.com](mailto:care@womanizer.com)

[womanizer.com](http://womanizer.com)

Designed in Germany. Made in China.

Date of issue: 10/2022.





# STILL WANT MORE?

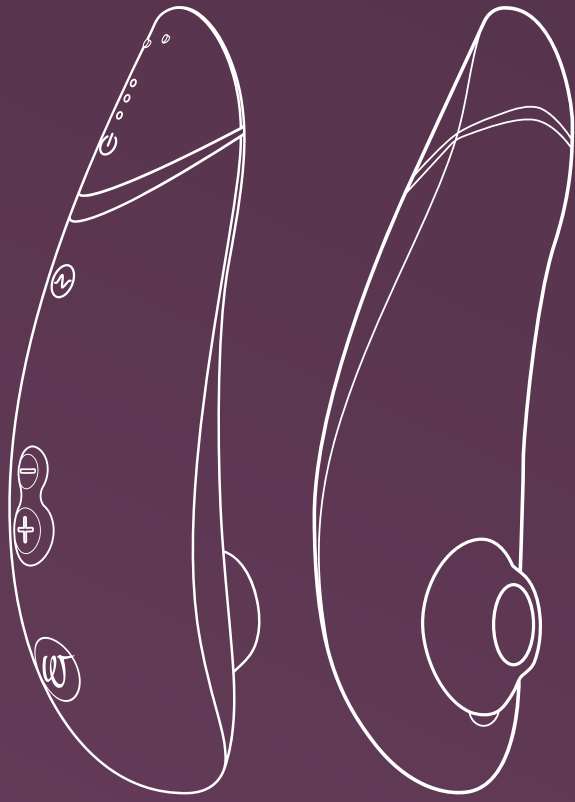

Pleasure Air  
Technology

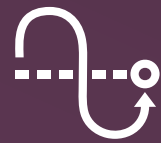

Autopilot



Smart Silence

**Premium 2**  
Define your luxury

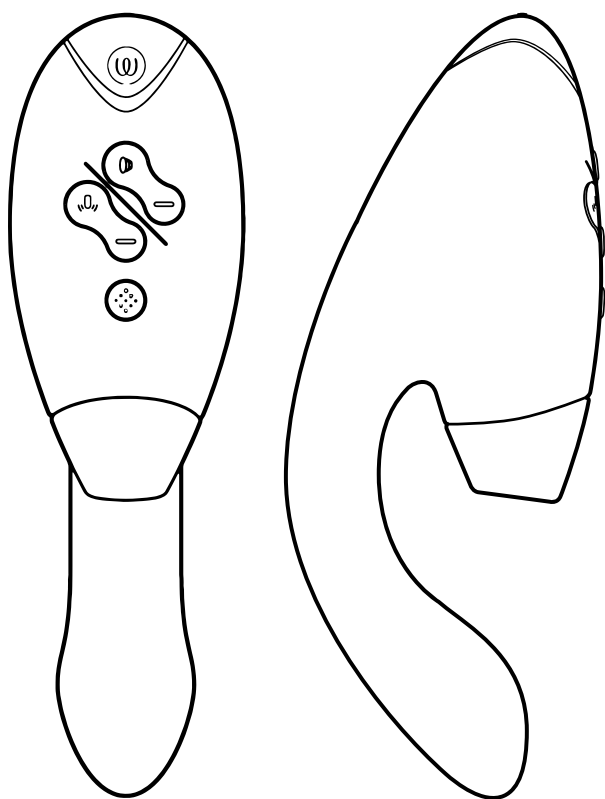

Pleasure Air  
Technology



Double Stimulation



Smart Silence

**DUO 2**  
Indulge in whole-body orgasms



#IMASTURBATE

# Hi!

Merci d'avoir choisi **WOMANIZER OG** !

Bienvenue dans un monde plein d'expériences sensuelles qui enrichiront votre intimité quotidienne.

En choisissant la marque **WOMANIZER**, vous êtes non seulement assuré(e) d'obtenir des orgasmes incomparables, mais aussi de découvrir un tout nouvel univers du plaisir.

Passez de bons moments avec votre produit **WOMANIZER OG**.

Dites oui au plaisir!



DESCRIPTION

MODE D'EMPLOI

SMART SILENCE

NETTOYAGE

CHARGEMENT

COMMENT PROFITER AU MIEUX  
DE VOTRE WOMANIZER OG

SAFETY INSTRUCTIONS

INFORMATIONS GÉNÉRALES

Please read the safety instructions in the  
Compliance & Safety Information before first use.

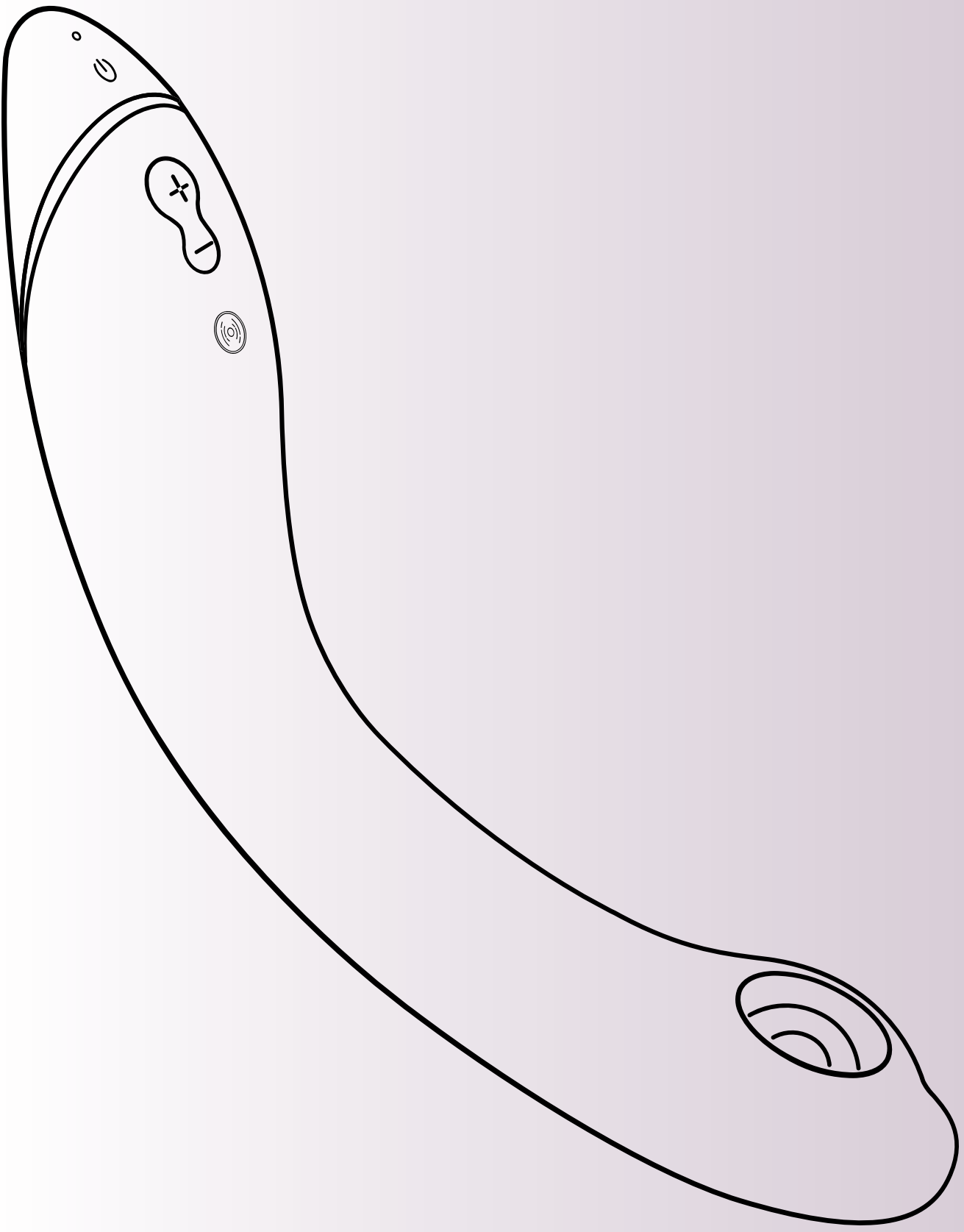

# DESCRIPTION

**Voyant lumineux**  
Chargement

**Marche/Arrêt  
Smart Silence**  
Appuyez pendant  
2 secondes

**Vibrations**  
Appuyez brièvement  
pour activer et  
augmenter  
l'intensité  
(3 niveaux)

**Pleasure Air Technology**  
(12 niveaux d'intensité)

**Marche/Arrêt**  
Appuyez pendant  
2 secondes

**Augmenter l'intensité**  
Appuyez brièvement sur (+)

**Diminuer l'intensité**  
Appuyez brièvement sur (-)

**Afterglow**  
Appuyez sur (-) pendant  
1 seconde



# MODE D'EMPLOI

## 1. Allumage

Appuyez pendant 2 secondes.  
La LED est allumée lorsque le produit est en marche.

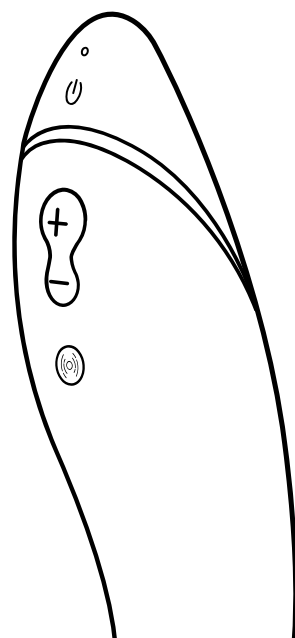

## 2. Utilisation

Pour vous mettre dans l'ambiance, utilisez d'abord **WOMANIZER OG** au niveau de votre clitoris.

Appliquez du lubrifiant à base d'eau sur votre sextoxy.

Une fois que vous avez fait monter l'excitation, insérez-le dans votre vagin et explorez les sensations au niveau de votre point G !

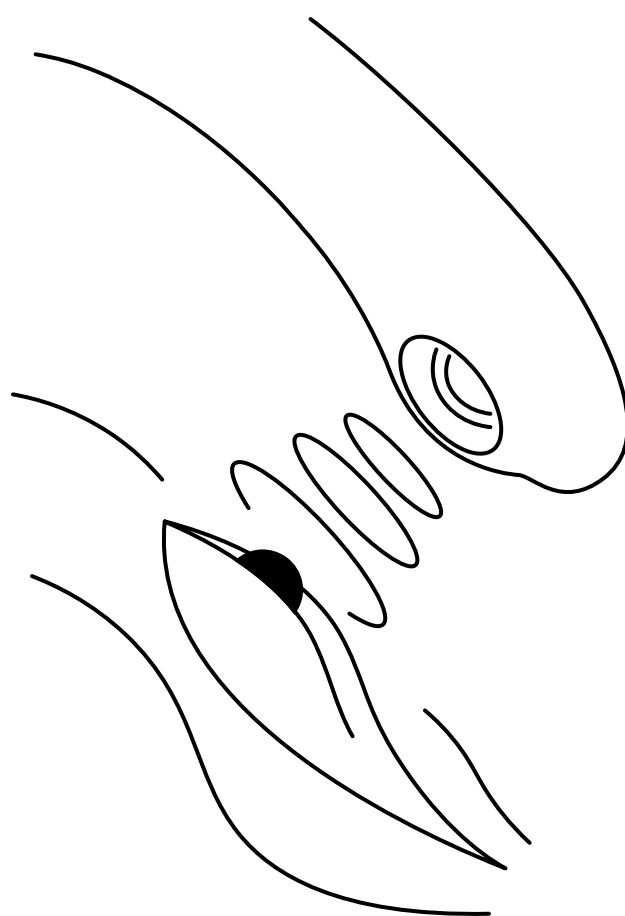

# MODE D'EMPLOI

## 3. Varier l'intensité

**Augmenter** —  
Appuyez brièvement  
**12 niveaux d'intensité**

**Augmenter** —  
Appuyez brièvement  
**3 niveaux de vibration**

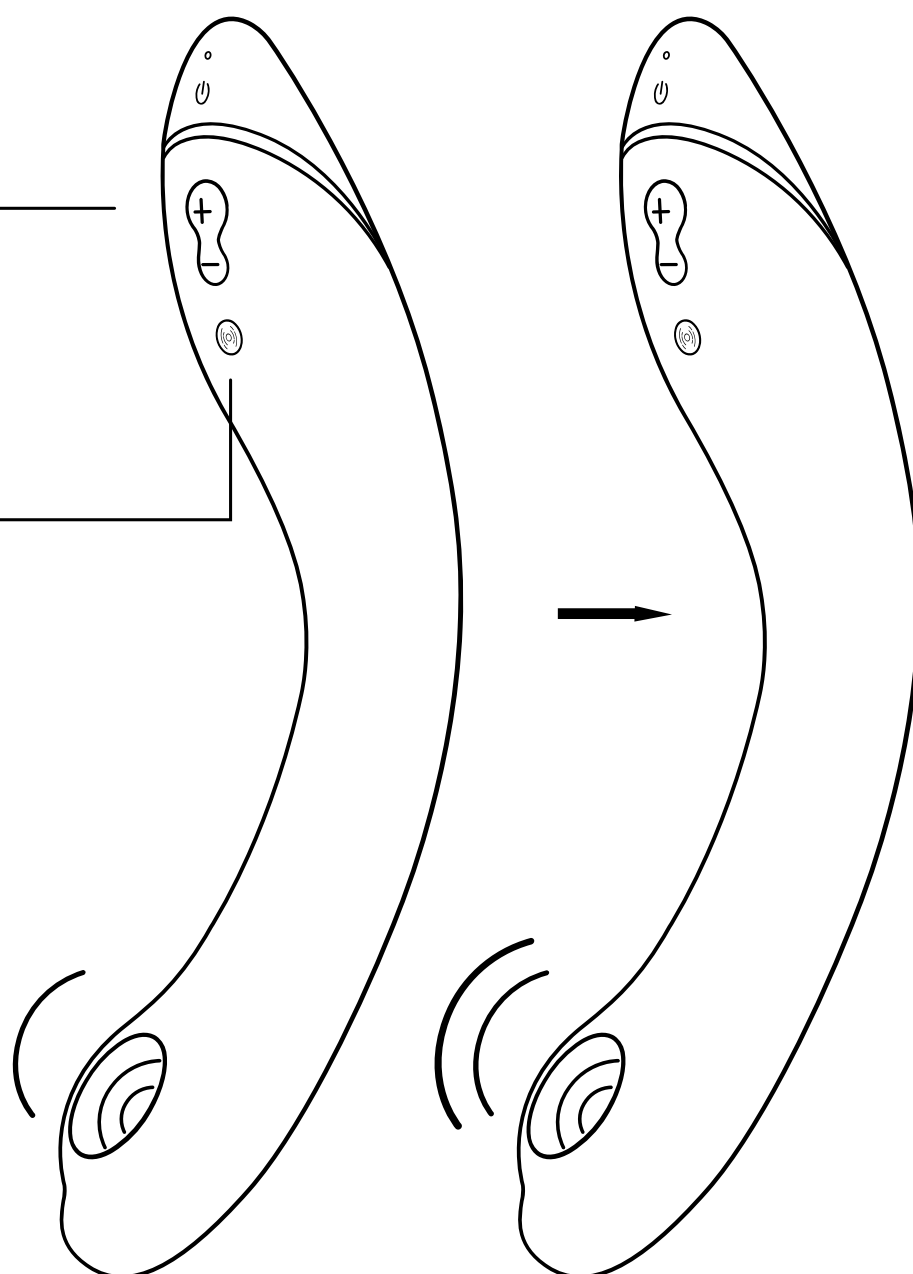

**Diminuer** —  
Appuyez brièvement

**Afterglow**  
Appuyez sur (-)  
pendant 1 seconde  
pour repasser au  
niveau d'intensité 1.

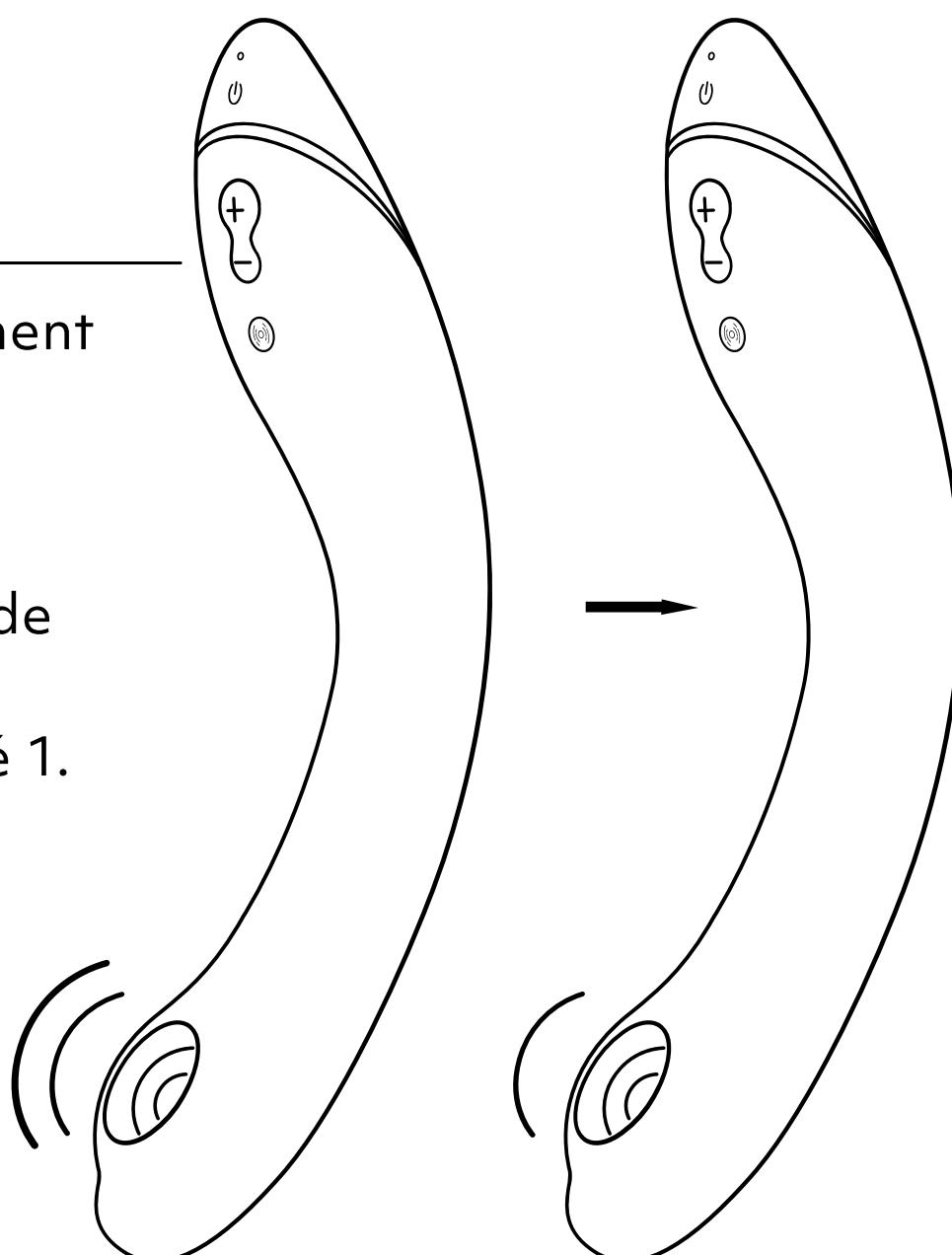



# MODE D'EMPLOI

4. **Éteindre** •  
Appuyez pendant  
2 secondes

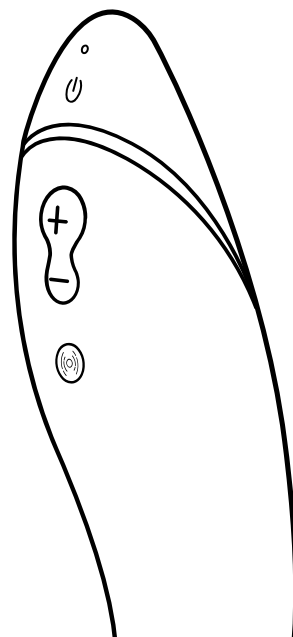

## SMART SILENCE

**WOMANIZER OG** se met uniquement en marche lorsqu'il s'approche de votre peau. Smart Silence est activé par défaut. Appuyez et maintenez enfoncés les boutons (+) et (-) pendant 2 secondes pour allumer ou éteindre la fonction Smart Silence.

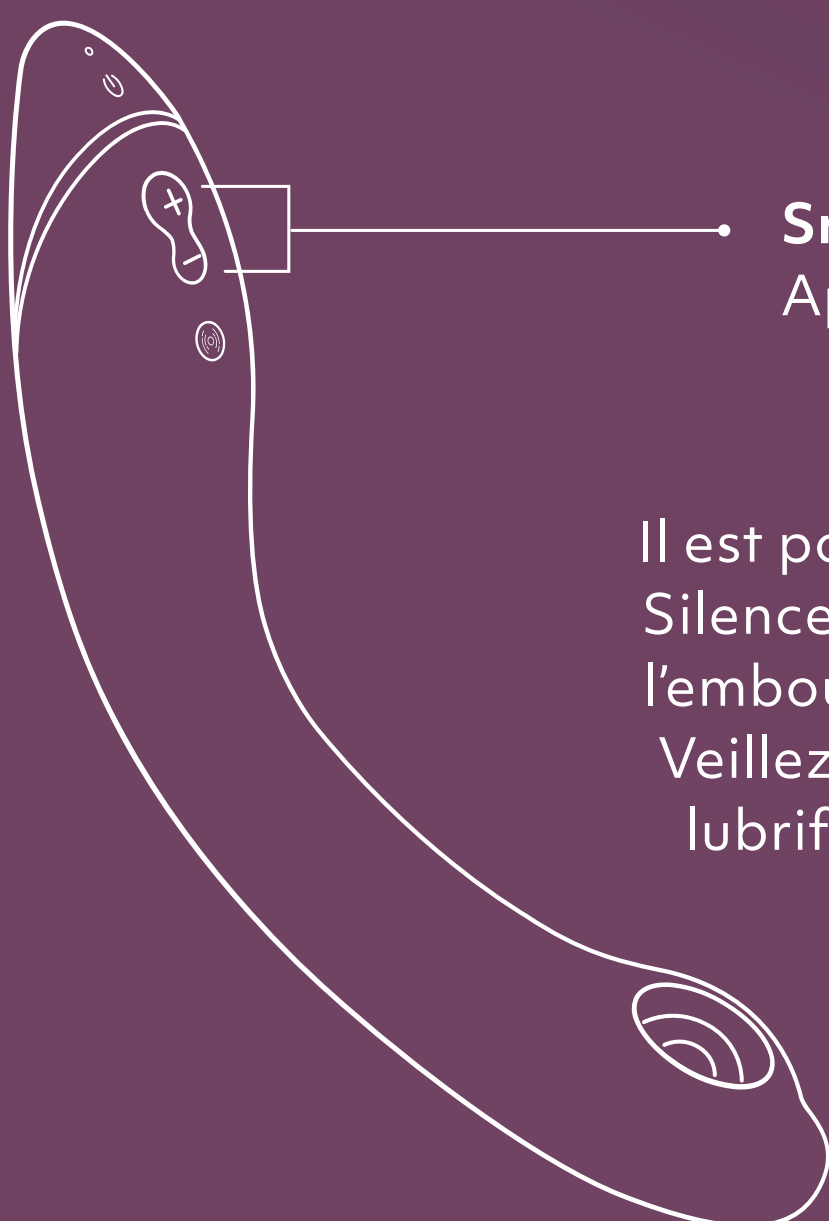

**Smart Silence Marche / Arrêt**  
Appuyez pendant 2 secondes

Il est possible que la fonction Smart Silence ne puisse pas être activée si l'embout de stimulation est mouillé. Veillez donc à ne pas appliquer de lubrifiant au niveau de l'embout.

# NETTOYAGE

Rincez à l'eau.

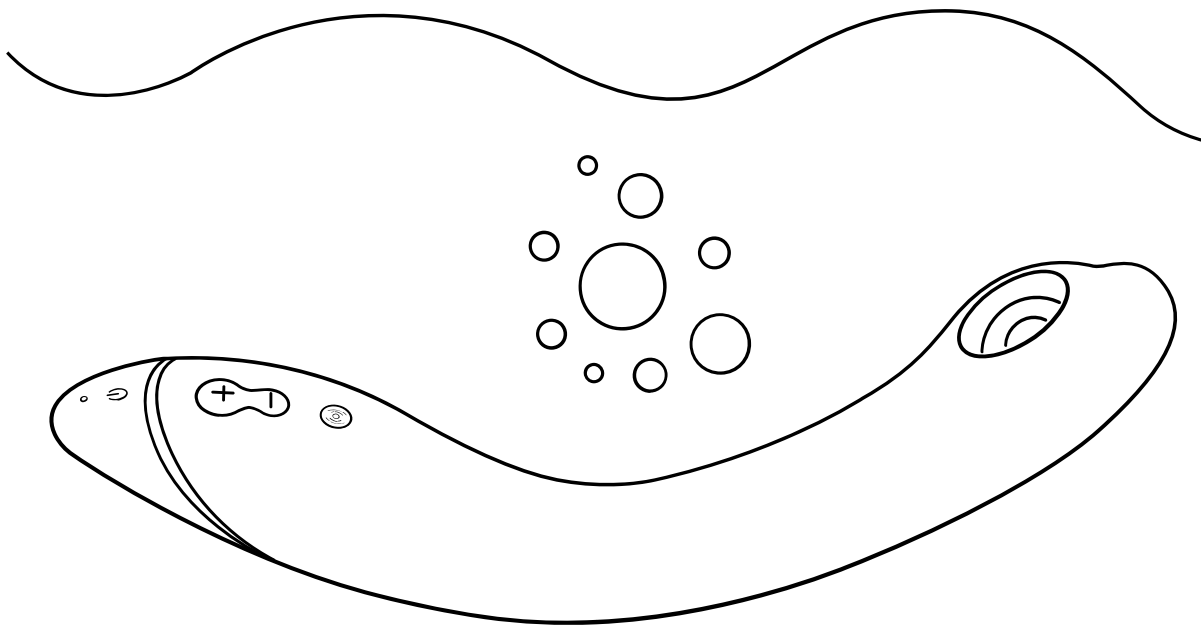

Utilisez un nettoyant pour sextoy.

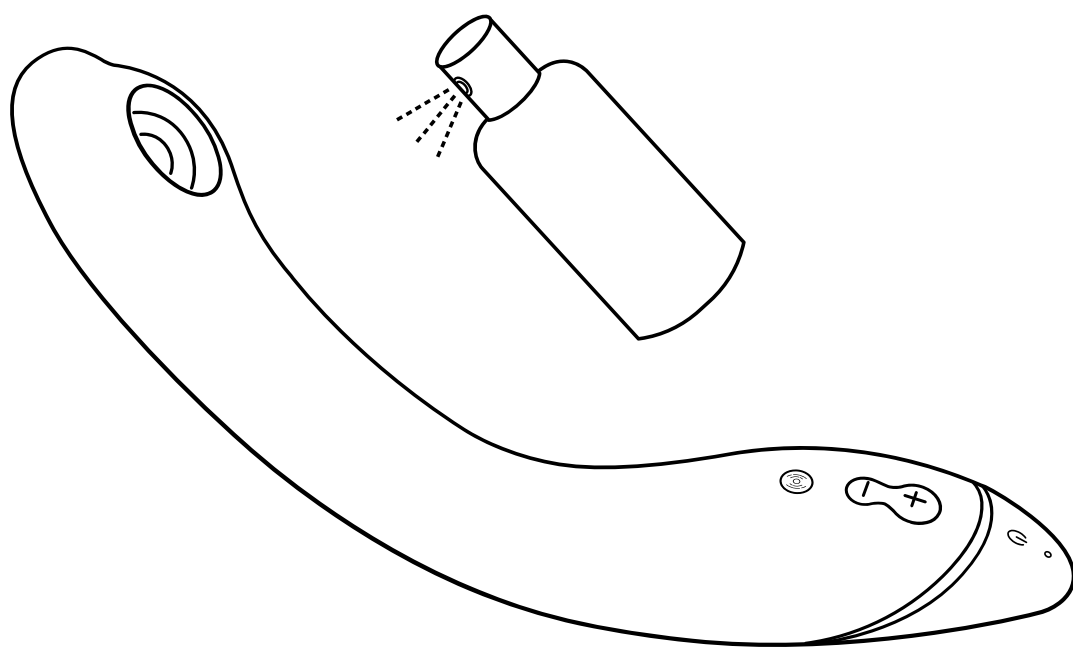

Séchez délicatement sans exercer de pression au niveau de la membrane.

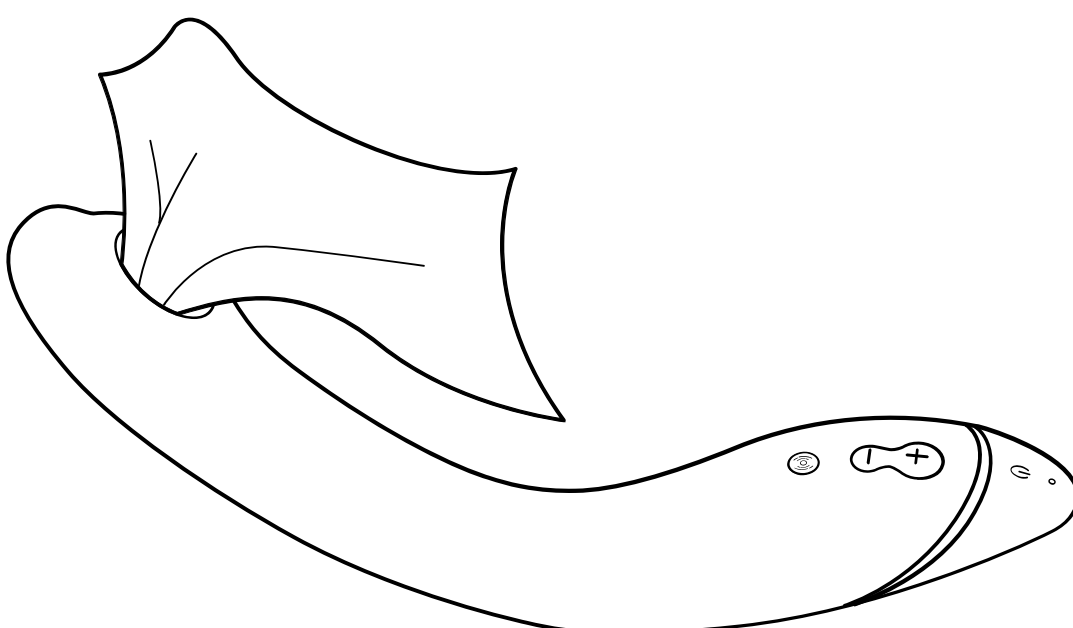

Étanche  
(IPX7)

# CHARGEMENT

Veillez charger votre **OG** avant la première utilisation.  
N'oubliez pas de recharger votre **OG** régulièrement afin de garantir une longue autonomie.

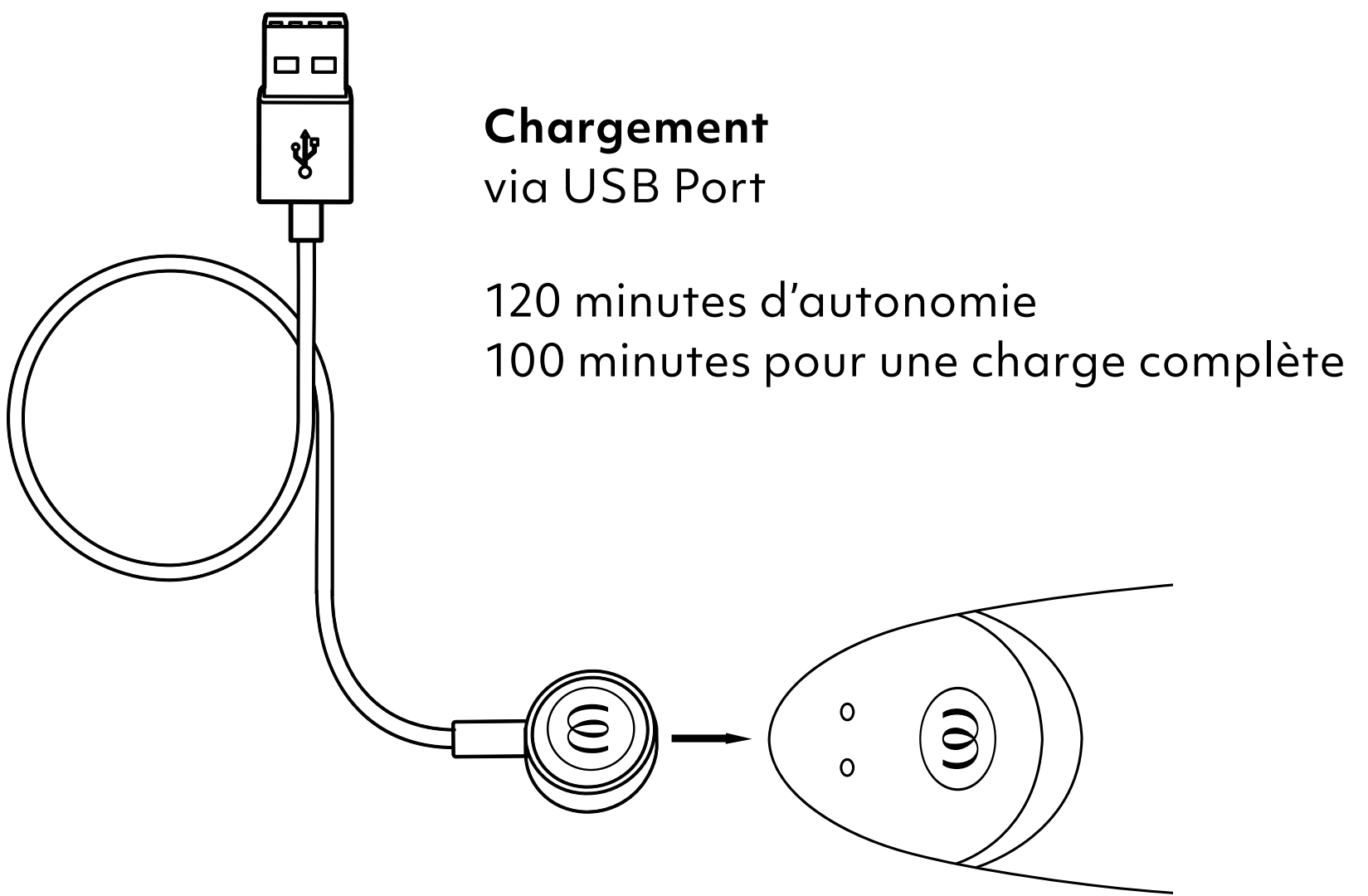

**Chargement**  
via USB Port

120 minutes d'autonomie  
100 minutes pour une charge complète

---

## LED

Marche/Arrêt/Chargement

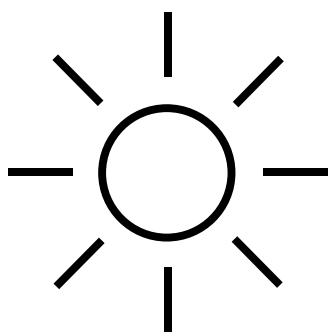

**Chargement terminé**  
La LED est allumée en continu

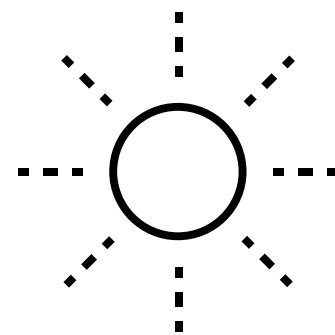

**Chargement**  
La LED clignote

# COMMENT PROFITER

au mieux de votre **WOMANIZER OG**



Le **point G** a été nommé ainsi en hommage au médecin Ernst Gräfenberg. Si ce nom est resté, on sait désormais qu'il ne s'agit pas tant d'un point, mais plutôt d'une zone plus étendue de la partie interne du clitoris et qui peut être stimulée de l'intérieur du vagin.

Le point G, recouvert par la paroi vaginale antérieure, est donc **moins sensible que la partie externe du clitoris**.

Puisqu'il est interne, le point G nécessite une stimulation plus longue. Sous l'effet de l'excitation, **il gonfle et devient plus sensible et réceptif aux stimulations**.

L'orgasme provoqué par la stimulation de cette zone est une expérience unique en son genre. S'il faut lui consacrer plus de temps et la chouchouter, elle offre **une jouissance d'autant plus intense et incomparable**.

# L'EXPÉRIENCE

Alors, **prenez votre temps** et essayez.

Appliquez du lubrifiant à base d'eau sur votre sextoy.



Mettez-vous dans l'ambiance et commencez par **la stimulation externe Pleasure Air**.

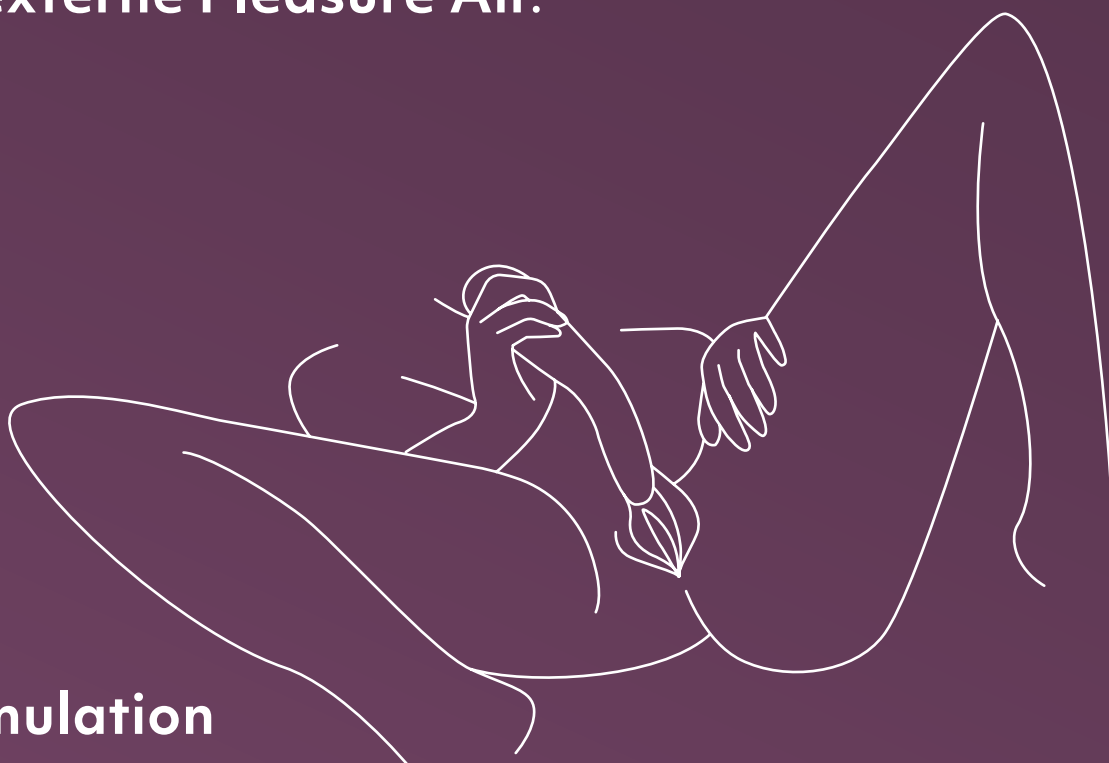
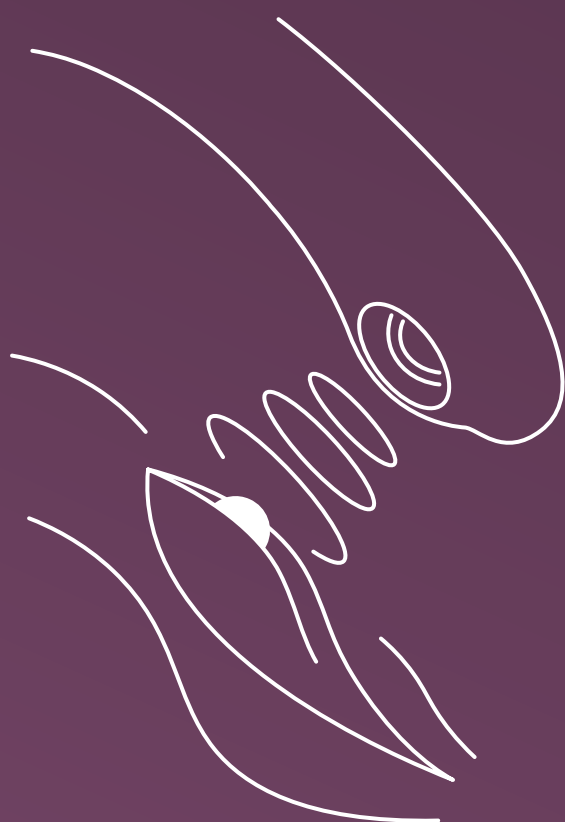

Passez ensuite à **la stimulation interne Pleasure Air associée à des vibrations**.



**OG** allie la stimulation Pleasure Air à des vibrations puissantes. Essayez les différents niveaux d'intensité et modes de vibration pour atteindre un orgasme incomparable.

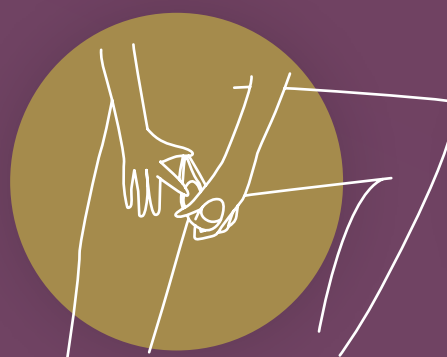
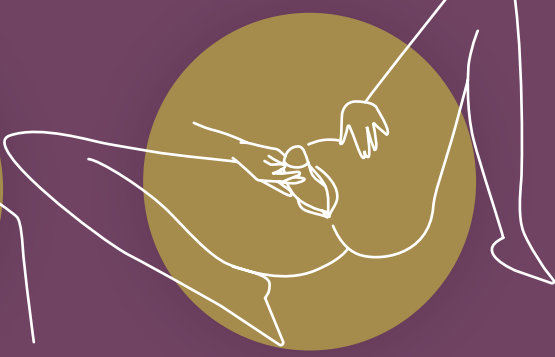
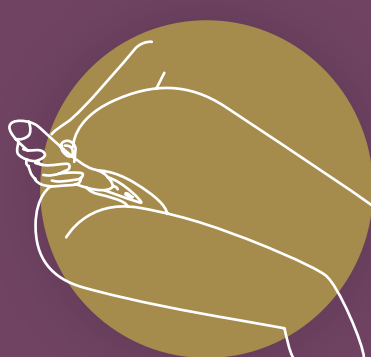

# SAFETY INSTRUCTIONS

## AVERTISSEMENT

Vendu uniquement en tant qu'article de divertissement. N'utilisez cet appareil que pour l'usage prévu. Tenez cet appareil hors de portée des enfants. Non conçu pour un usage médical. Si vous suivez actuellement un traitement médical et/ou souffrez d'une maladie qui requiert l'utilisation d'un dispositif médical, veuillez consulter votre médecin traitant avant d'utiliser cet appareil. Renoncez immédiatement à utiliser cet appareil si vous constatez des irritations cutanées, des douleurs ou une sensation de malaise et consultez votre médecin traitant.

Cet appareil ne doit être utilisé que par des adultes. Les personnes présentant des capacités physiques, sensorielles ou mentales réduites ou ne disposant pas de l'expérience ou des connaissances nécessaires doivent être placées sous supervision et recevoir des instructions concernant l'utilisation sûre de cet appareil afin de comprendre les dangers éventuels. Les enfants ne doivent pas jouer avec cet appareil ni effectuer son nettoyage et sa maintenance. Ne pas utiliser sur des zones gonflées ou inflammées de la peau.

- Enlever les piercings ou les bijoux dans la zone intime avant l'utilisation.
- Veuillez toujours nettoyer l'appareil avant et après son utilisation en vous conformant aux instructions données dans le manuel.
- Pour éviter tout dommage, n'exposez jamais l'appareil ou son chargeur à des températures supérieures à 45°C, ne tentez jamais de le démonter et évitez tout dommage mécanique ou électrique.
- Partager des sex toys peut favoriser la transmission de maladies sexuelles. Ne partagez pas vos sex toys avec d'autres utilisateurs que votre partenaire habituel et utilisez des mesures de protection si cela s'avère nécessaire. N'utilisez pas l'appareil si vous détectez des fissures ou des signes de dégradation du matériau de couverture.
- Ce produit n'est pas conçu pour un usage anal. Ne pas utiliser pour des pénétrations anales!
- Ne placez pas la partie souple de votre appareil sur une surface absorbante afin d'éviter les taches.
- Vérifiez régulièrement l'état du chargeur et de l'appareil et renoncez à utiliser l'appareil si certains de ses éléments sont endommagés.
- Les champs magnétiques peuvent influencer les composants mécaniques et électroniques tels que les stimulateurs cardiaques. Ne pas utiliser le produit directement au-dessus du stimulateur cardiaque. Si vous êtes concerné, veuillez contacter votre médecin traitant avant l'utilisation pour obtenir de plus amples renseignements. Ne pas placer des cartes avec des bandes magnétiques (par exemple des cartes de crédit) à proximité du produit, car elles peuvent être endommagées par l'aimant incorporé.
- Si l'appareil ne semble pas fonctionner normalement, veuillez l'éteindre et contacter le service d'assistance sur notre site web.

## CHARGE

- Avant la première utilisation du chargeur, vérifiez le voltage local car celui-ci ne doit pas excéder le voltage maximal indiqué sur le chargeur.
- L'appareil ne doit être rechargé qu'à un voltage approprié et extrêmement bas correspondant à celui indiqué sur l'appareil.
- N'utilisez et ne nettoyez pas le produit pendant le chargement de la batterie.
- N'immergez jamais le chargeur ou le câble de recharge dans de l'eau ou dans d'autres fluides.
- L'appareil contient des piles non remplaçables.
- Cet appareil contient une pile li-ion rechargeable.
- Débrancher le câble de charge de l'alimentation électrique après chaque processus de charge.

## POUR UNE UTILISATION OPTIMALE DE CET APPAREIL, VEUILLEZ RESPECTER LES CONSIGNES SUIVANTES :

- Pour garantir une longue autonomie, veuillez régulièrement recharger l'appareil, même si vous ne l'utilisez pas.
- À conserver dans un endroit sec sans exposition directe au soleil.
- Nous vous recommandons l'utilisation d'un lubrifiant à base d'eau pour l'usage de l'appareil. Pour prévenir tout dommage, n'utilisez pas de lubrifiants, de gels ou d'huiles de massage parfumés ou à base de silicone ou d'alcool.



## CONSIGNES RELATIVES AUX BATTERIES

La réglementation européenne nous impose de transmettre les consignes suivantes :

- Les batteries et les piles ne doivent pas être jetées avec les déchets ménagers. En tant qu'utilisateur final, vous êtes légalement tenu de restituer les batteries usagées. Pour ce faire, utilisez les points de dépôt officiels tels que les points de collecte des services publics d'élimination des déchets. Les batteries usagées que nous proposons ou avons proposées à l'état neuf peuvent nous être retournées. Pour cela, vous pouvez nous contacter à cette adresse : [care@womanizer.com](mailto:care@womanizer.com). Pour éviter tout risque de court-circuit, les pôles des batteries lithium doivent être recouverts d'un ruban adhésif avant la restitution. Pour des raisons de sécurité, nous vous demandons de ne pas nous retourner les batteries par voie postale. À ce sujet, nous vous renvoyons aux règlements des transporteurs relatifs à l'envoi de marchandises dangereuses.
- Si les batteries sont solidement installées à l'intérieur du produit, n'essayez en aucun cas de les retirer vous-même. Cela pourrait endommager l'appareil de manière définitive. Vos obligations en tant que client relèvent par ailleurs de la directive WEEE et de sa transposition en droit national.
- Afin de réduire les déchets et d'éviter la dégradation de l'environnement par les dépôts sauvages, les instructions et consignes de sécurité doivent être respectées.
- Les batteries usagées contiennent des substances toxiques qui peuvent être nocives pour l'environnement ou pour votre santé si les batteries ne sont pas stockées ou éliminées de manière appropriée. Cela s'applique en particulier aux batteries contenant du lithium. Les batteries contiennent également des matières premières importantes telles que le fer, le zinc, le manganèse ou le nickel qui peuvent être recyclées. Le tri sélectif permet de recycler ces matières premières et d'éviter les effets nocifs des substances toxiques libérées sur l'environnement et la santé des personnes.
- Le symbole représentant une poubelle barrée d'une croix indique que vous ne devez pas jeter les batteries et les piles avec les déchets ménagers.

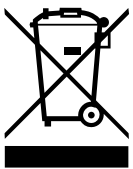

En fonction des conditions légales, les abréviations suivantes (leur signification est indiquée ci-dessous) doivent apparaître sous ce symbole :

- Hg : la batterie contient plus de 0,0005 % en poids de mercure
- Pb : la batterie contient plus de 0,004 % en poids de plomb
- Cd : la batterie contient plus de 0,002 % en poids de cadmium

## CONSIGNES POUR LA MISE AU REBUT D'APPAREILS ÉLECTRIQUES

La réglementation européenne nous impose de transmettre les consignes suivantes :

- Nous attirons l'attention des propriétaires d'appareils électriques sur le fait que, conformément aux dispositions légales en vigueur, les appareils électriques usagés ne doivent pas être jetés avec les déchets ménagers, mais doivent faire l'objet d'une collecte séparée. Les batteries et les piles qui ne sont pas solidement installées dans l'appareil électrique usagé, ainsi que les ampoules qui peuvent être retirées de l'appareil usagé sans être détruites, doivent être retirées de l'appareil usagé sans occasionner de destruction et éliminées conformément à la procédure prévue avant que celui-ci ne soit déposé dans un point de collecte. Pour la mise au rebut de batteries, veuillez respecter les consignes particulières. Le symbole de la poubelle barrée d'une croix, représenté ci-dessous et figurant sur les appareils électriques usagés, indique en outre l'obligation de tri sélectif :

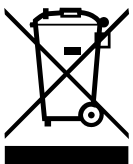

- Conformément à la directive WEEE et à sa transposition en droit national, nous sommes tenus, en tant que distributeur d'appareils électriques, de reprendre gratuitement certains appareils électriques usagés.
- Lorsque vous faites l'acquisition d'un nouvel appareil électrique ou électronique, vous pouvez nous remettre gratuitement un appareil électrique usagé remplissant sensiblement les mêmes fonctions que le nouvel appareil. Si les dimensions de votre appareil électrique usagé ne dépassent pas 25 cm en tout sens, vous pouvez également nous le remettre gratuitement, même si vous n'achetez pas de nouvel appareil. Pour cela, vous pouvez nous contacter à cette adresse : [care@womanizer.com](mailto:care@womanizer.com). Nous pourrions alors organiser la restitution de l'appareil électrique. Pour des raisons de sécurité, nous vous demandons de ne pas nous envoyer des éléments d'éclairage (ampoules par exemple). Pour restituer des éléments d'éclairage, veuillez utiliser les points de collecte des services publics d'élimination des déchets ou nous contacter directement en utilisant l'adresse électronique susmentionnée.

- Vous pouvez aussi déposer les appareils électriques usagés dans tous les points de collecte des services publics d'élimination des déchets. En respectant les règles de tri sélectif pour l'élimination de vos appareils électriques usagés, vous contribuez grandement au réemploi, au recyclage et à la revalorisation des appareils usagés.
- En tant qu'utilisateur final, il vous appartient d'effacer les données à caractère personnel qui figurent sur les appareils électriques usagés à mettre au rebut avant de les déposer.
- Afin de réduire les déchets, les instructions et consignes de sécurité doivent être respectées et toutes les possibilités de réparation examinées.



# GENERAL INFORMATION

## ELECTRICAL RATING

**Model:** OG

**Model No.:** TES10A

**Power Input:**

3,7 V=0,62 A: Built-in Li-Polymer rechargeable battery.

5 V=0,5 A: When charged using USB.

Use USB AC adaptor (not included) with power output corresponding to product rating. Use original provided cable only."

## CONTENT OF DELIVERY

Womanizer OG G-Spot vibrator, USB charging cable (AC adapter not included), cotton storage pouch, quick start guide, safety instructions

## ENVIRONMENTAL PROTECTION

As a distributor of electronic devices, we are legally obliged to accept the return of waste electrical and electronic devices free of charge. We expressly state that you as the user are legally obliged to return used batteries.

Never throw away electronic devices or batteries in the household waste. The symbol shown below (crossed-out wheeled bin) is intended to expressly remind you of this.

## MANUFACTURED AND DISTRIBUTED BY

**WOW Tech Europe GmbH**

Hermann-Blankenstein-Strasse 5

10249 Berlin

[www.wowtech.com](http://www.wowtech.com)

WOW Tech Europe GmbH reserves the right to make technical changes and changes to the design that serve to improve the device.

For information regarding patents see [womanizer.com/patents](http://womanizer.com/patents).

## CUSTOMER CARE

[care@womanizer.com](mailto:care@womanizer.com)

[womanizer.com](http://womanizer.com)

Designed in Germany. Made in China.

Date of issue: 10/2022.



# VOUS EN VOULEZ TOUJOURS PLUS ?

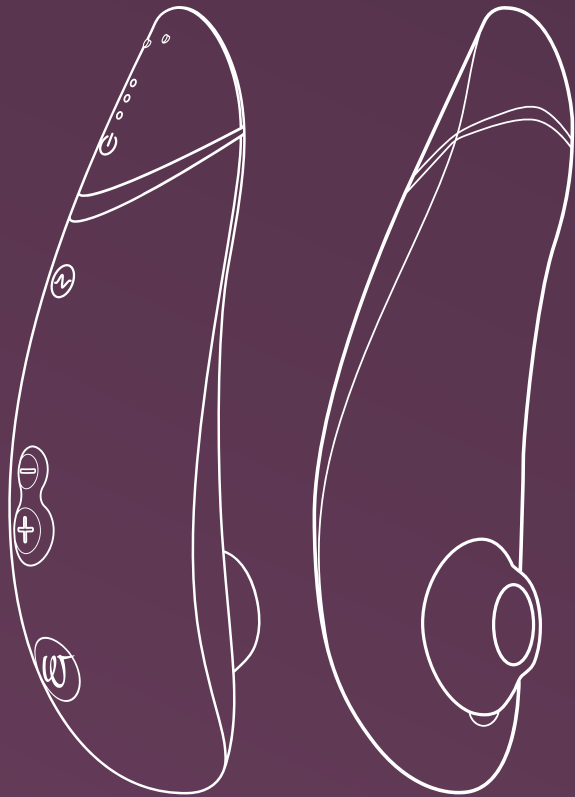

Pleasure Air  
Technology

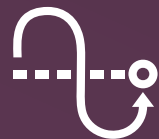

Autopilot



Smart Silence

**Premium 2**  
Define your luxury

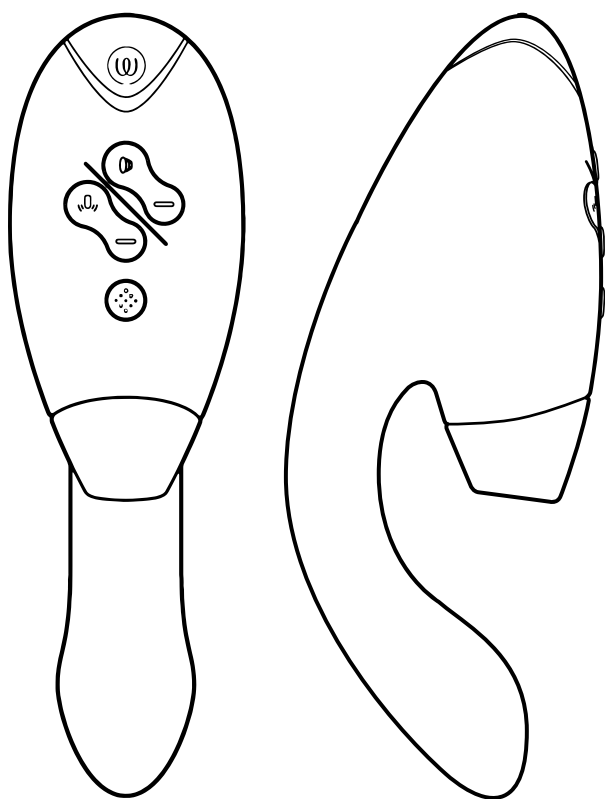

Pleasure Air  
Technology



Double Stimulation



Smart Silence

**DUO 2**  
Indulge in whole-body orgasms



#IMASTURBATE

# Hi!

Schön, dass Du Dich für den **WOMANIZER OG** entschieden hast.

Wir heißen Dich willkommen in einer Welt voll sinnlicher Erlebnisse, die Dein Leben bereichern werden. Mit der Entscheidung für den **WOMANIZER** sind Dir nicht nur unvergleichliche Orgasmen sicher – sondern auch ein vollkommen neues Lustgefühl.

Hab viel Freude mit Deinem **WOMANIZER OG** – und einen Orgasmus nach dem anderen.

Liebe Dich selbst!



**PRODUKTBESCHREIBUNG**

**BENUTZUNG**

**SMART SILENCE**

**REINIGUNG**

**LADEN**

**EINIGE RAFFINIERTE DETAILS**

**SAFETY INSTRUCTIONS**

**ALLGEMEINE INFORMATIONEN**

Please read the safety instructions in the  
Compliance & Safety Information before first use.

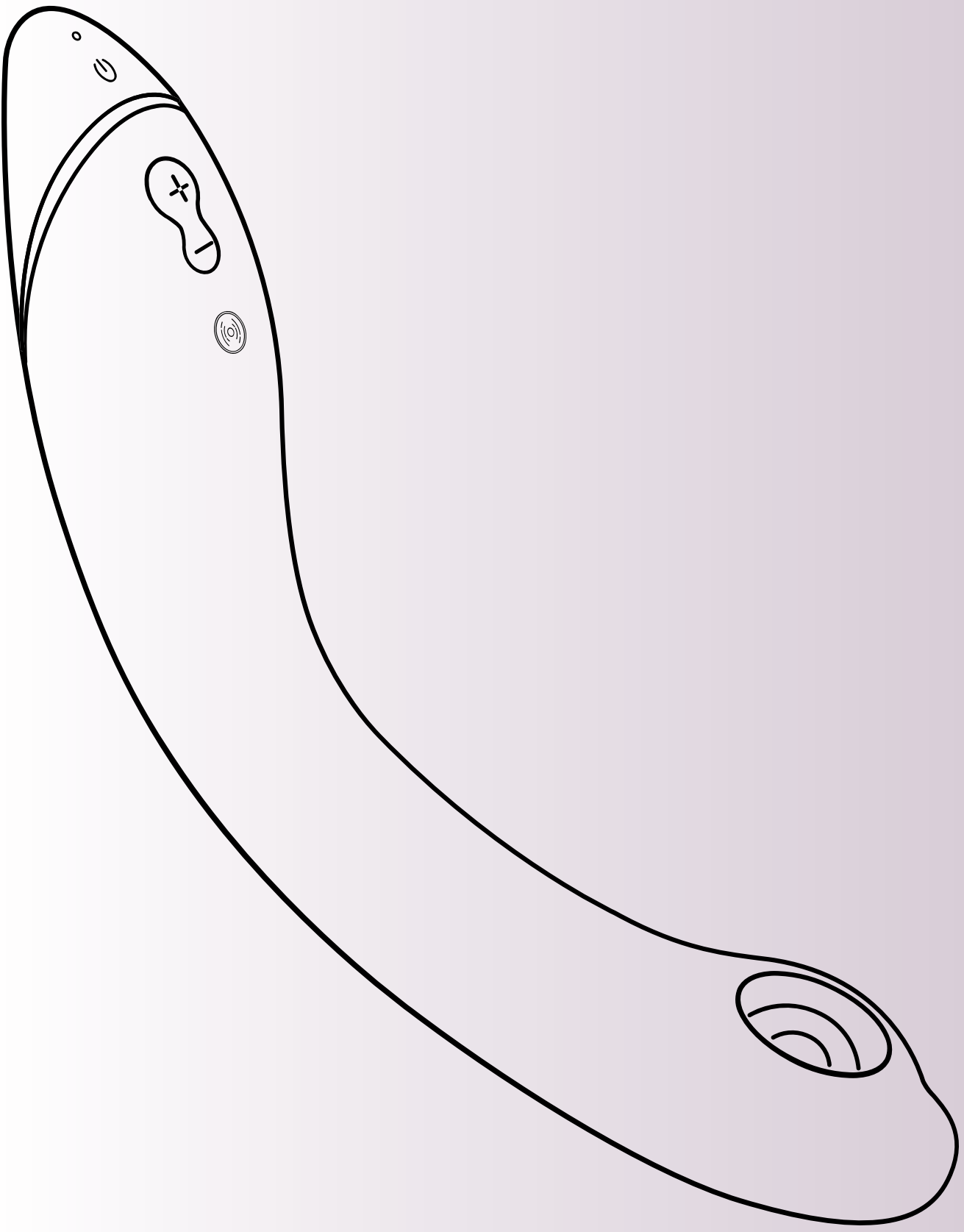

# PRODUKTBESCHREIBUNG

**LED-Anzeige**  
Ein/Aufladen

**Smart Silence**  
ein-/ausschalten  
2 Sekunden gedrückt halten

**Vibration**  
Zum Aktivieren  
und Erhöhen der  
Intensität kurz  
drücken  
(3 Vibrationsmuster)

**Pleasure Air Technology**  
(12 Intensitätsstufen)

**Ein/Aus**  
2 Sekunden gedrückt halten

**Intensität erhöhen**  
(+) kurz drücken

**Intensität verringern**  
(-) kurz drücken

**Afterglow**  
(-) 1 Sekunde gedrückt halten



# BENUTZUNG

## 1. Einschalten

2 Sekunden gedrückt halten.  
Die LED zeigt an, dass das  
Produkt eingeschaltet wurde.

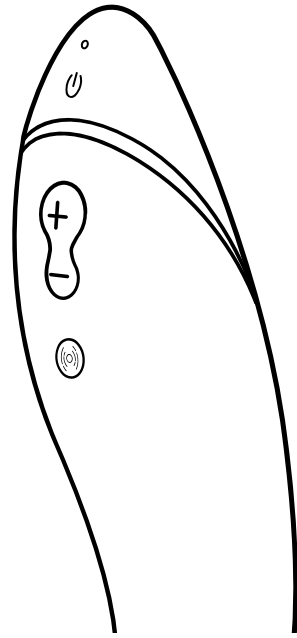

## 2. Benutzen

Verwöhne zunächst Deine  
Klitoris mit dem **OG**,  
um in Stimmung zu kommen.

Trage etwas Gleitmittel auf  
Wasserbasis auf die Oberfläche  
des **OG** auf.

Sobald Du ausreichend erregt bist,  
führen den **OG** ein und gehe auf  
Entdeckungsreise rund um Deinen  
G-Punkt!

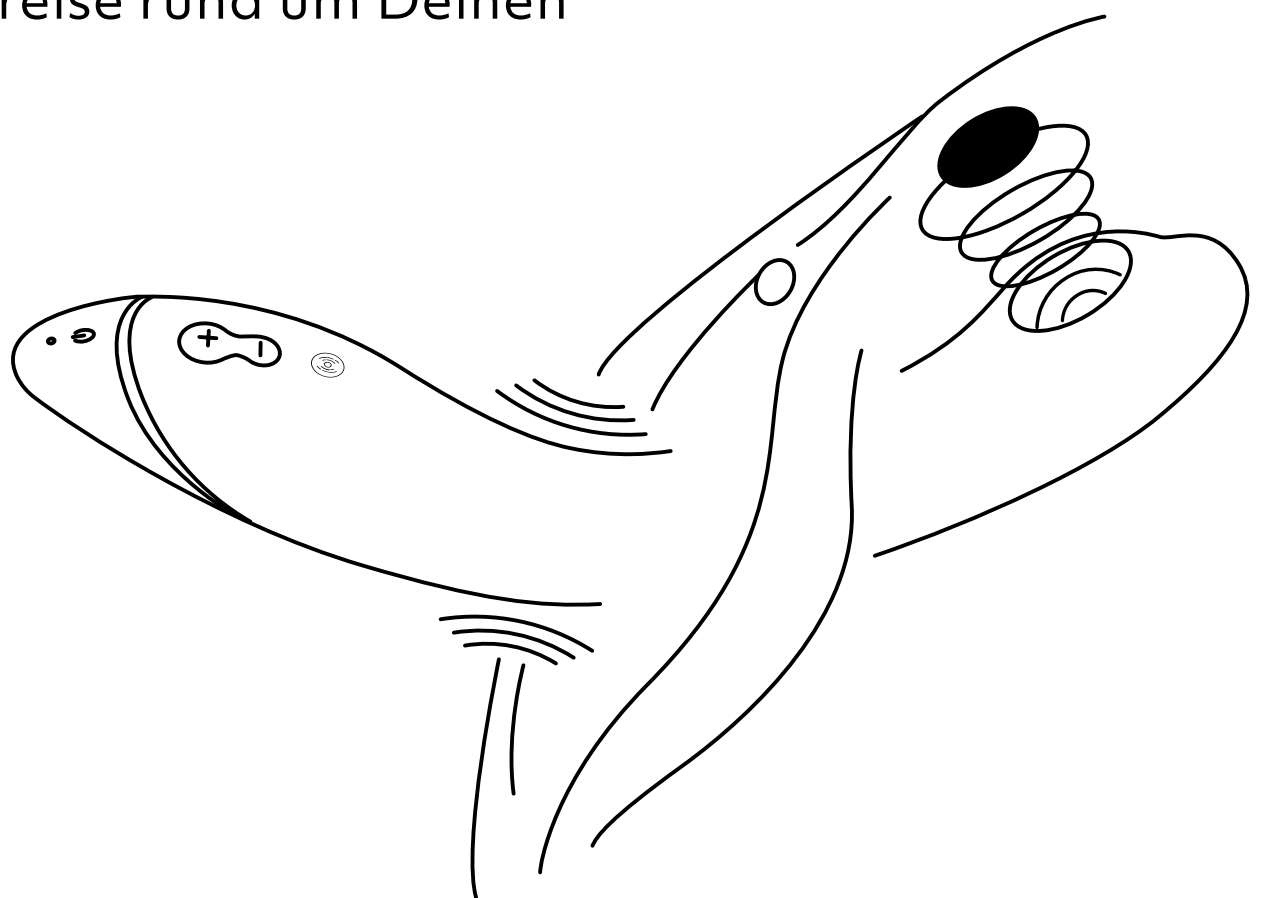
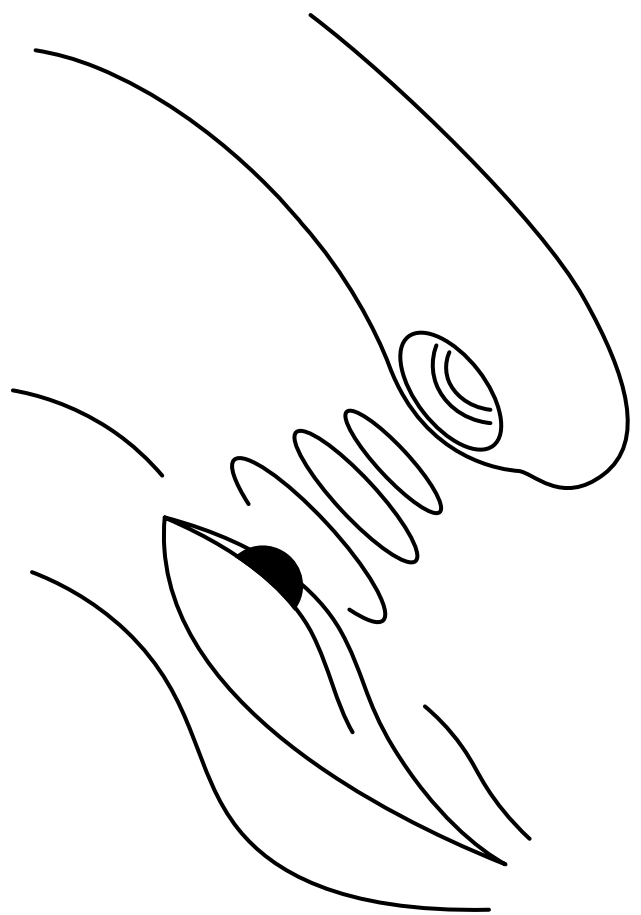



# BENUTZUNG

## 3. Intensität ändern

**Erhöhen**

Kurz drücken

**12 Intensitätsstufen**

**Erhöhen**

Kurz drücken

**3 Vibrationsmuster**

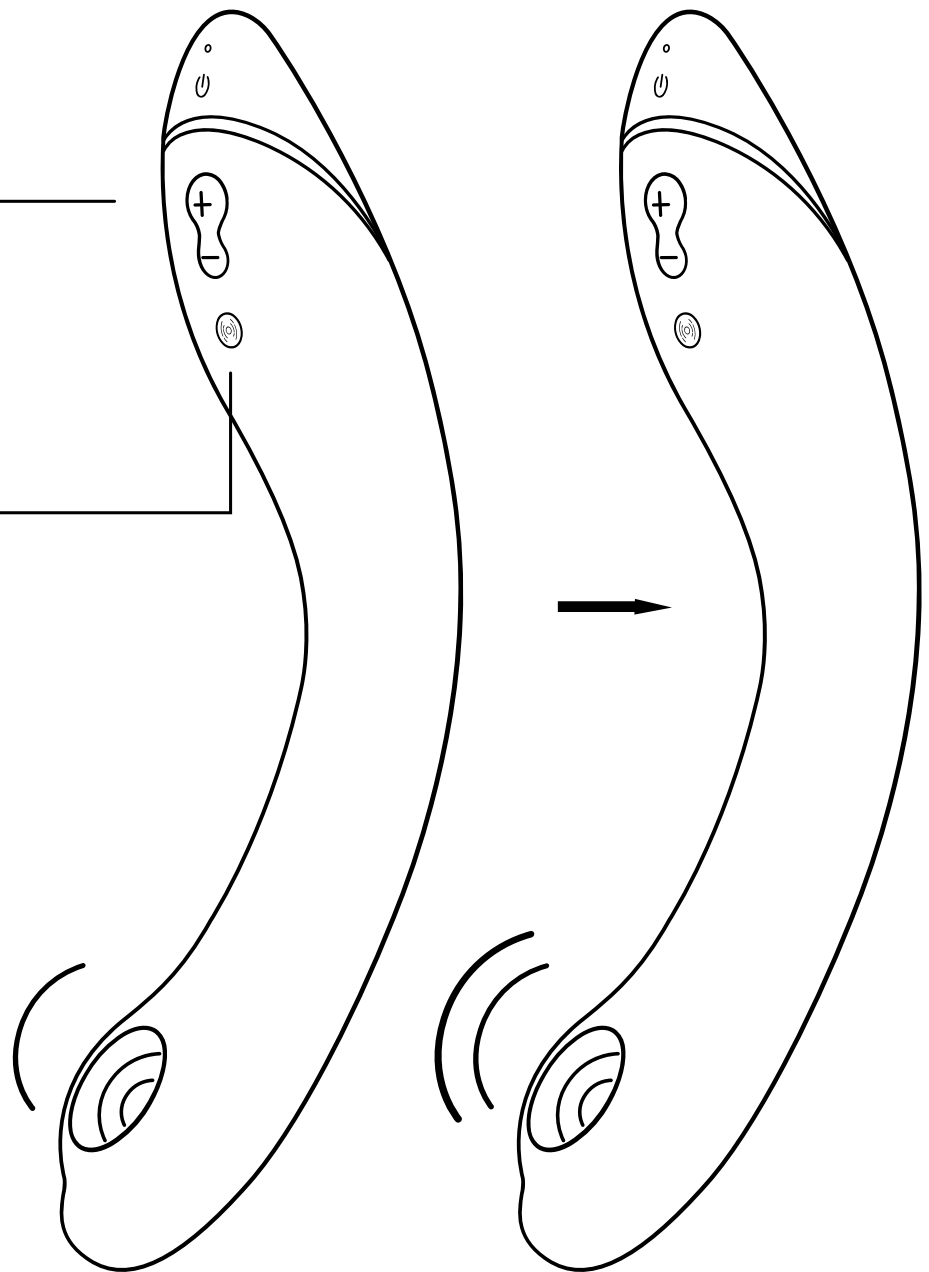

**Verringern**

Kurz drücken

**Afterglow**

Drücke (-) für 1 Sekunde, um auf Intensitätsstufe 1 zurückzuschalten.

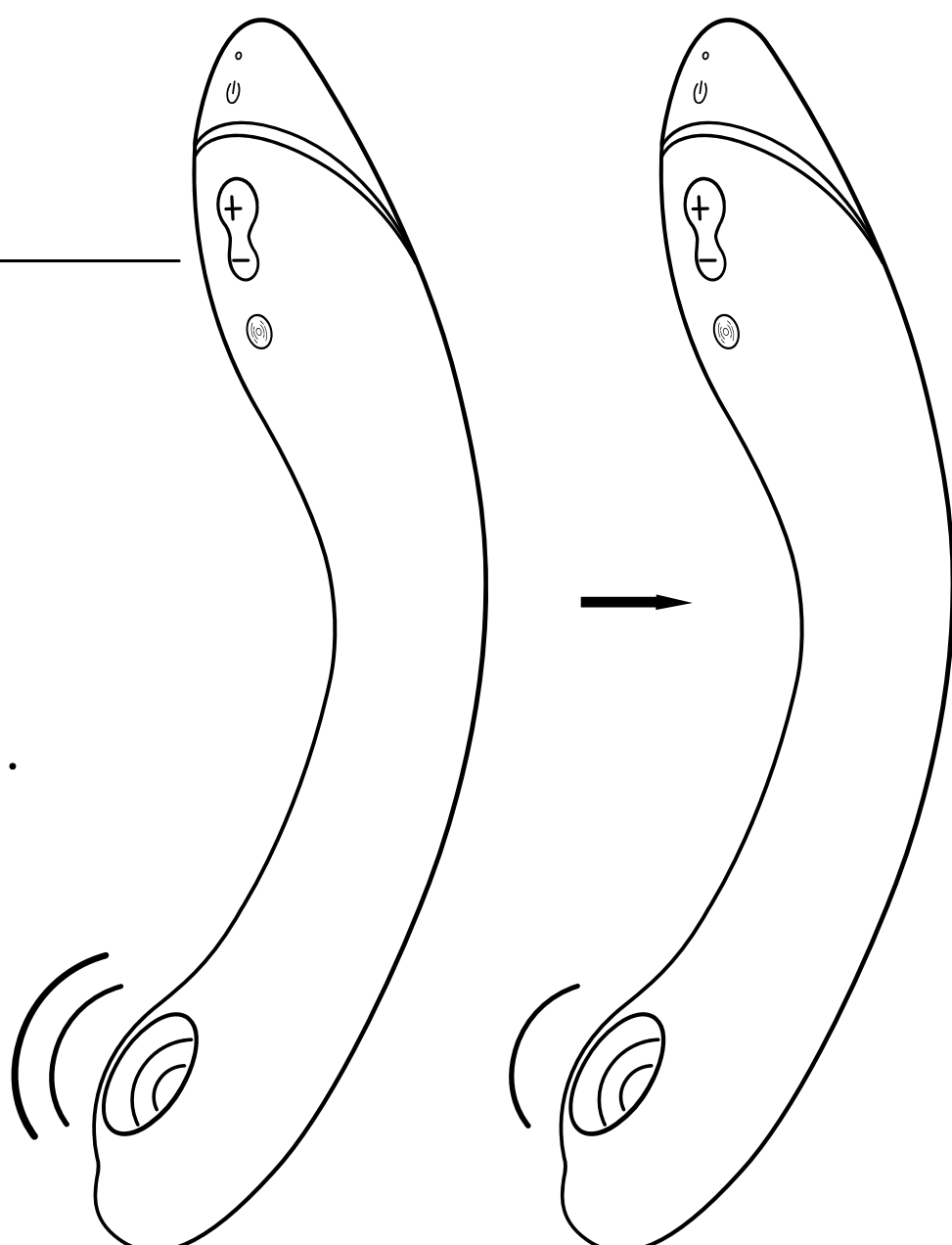

# BENUTZUNG

## 4. Ausschalten

2 Sekunden gedrückt halten

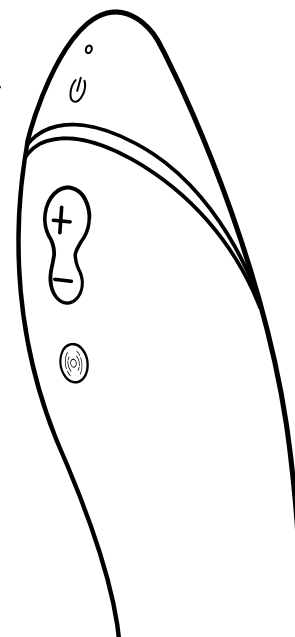

## SMART SILENCE

Der **OG** schaltet sich erst ein, wenn er schon fast Deine Haut berührt. Smart Silence wird standardmäßig aktiviert. Halte die Plus- und Minus-Taste zwei Sekunden lang gedrückt, um Smart Silence ein- bzw. auszuschalten.



**Smart Silence wird standardmäßig aktiviert**  
2 Sekunden gedrückt halten

Smart Silence funktioniert möglicherweise nicht, wenn der Stimulationskopf nass ist. Achte deshalb darauf, dass kein Gleitmittel in den Pleasure Air Kopf gelangt.

# REINIGUNG

Reinige das Toy unter Wasser.

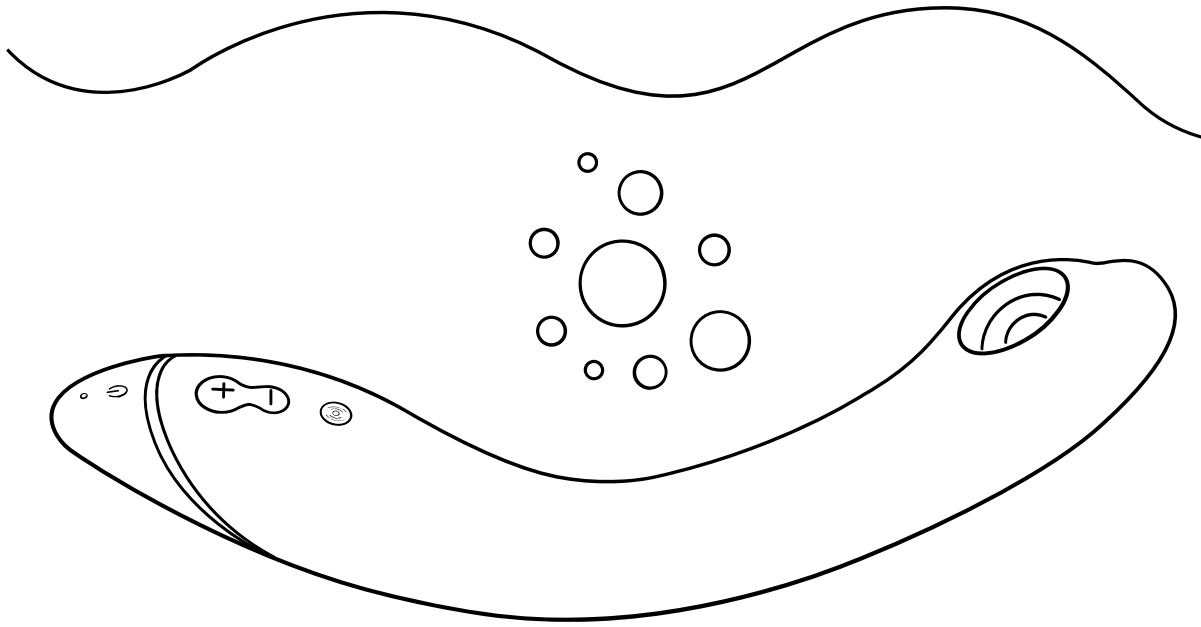

Trage Toy Cleaner auf.

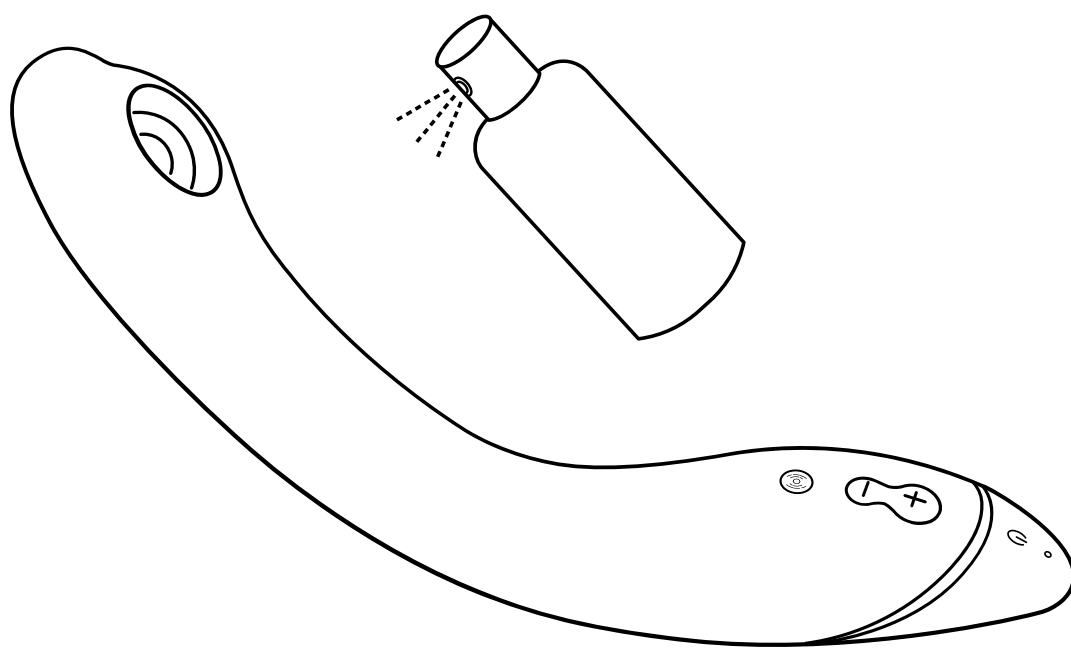

Trockne das Toy vorsichtig, ohne zu viel Druck auf die Membran auszuüben.

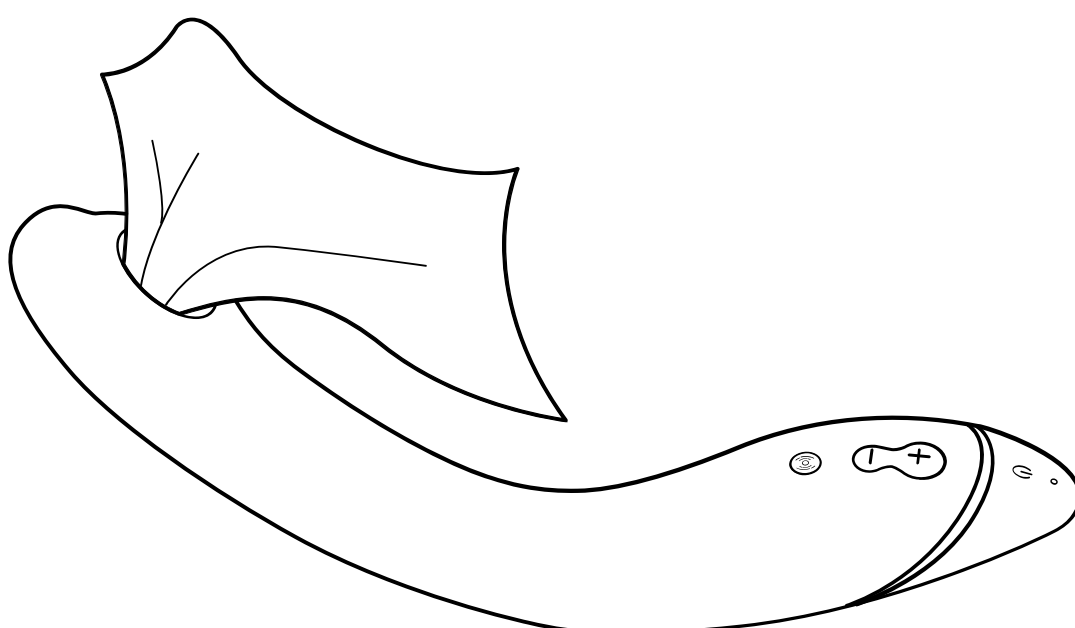

Wasserdicht  
(IPX7)

# LADEN

Lade Deinen **OG** vor dem ersten Gebrauch auf. Für eine lange Akkulebensdauer solltest Du Deinen **OG** regelmäßig vollständig aufladen.

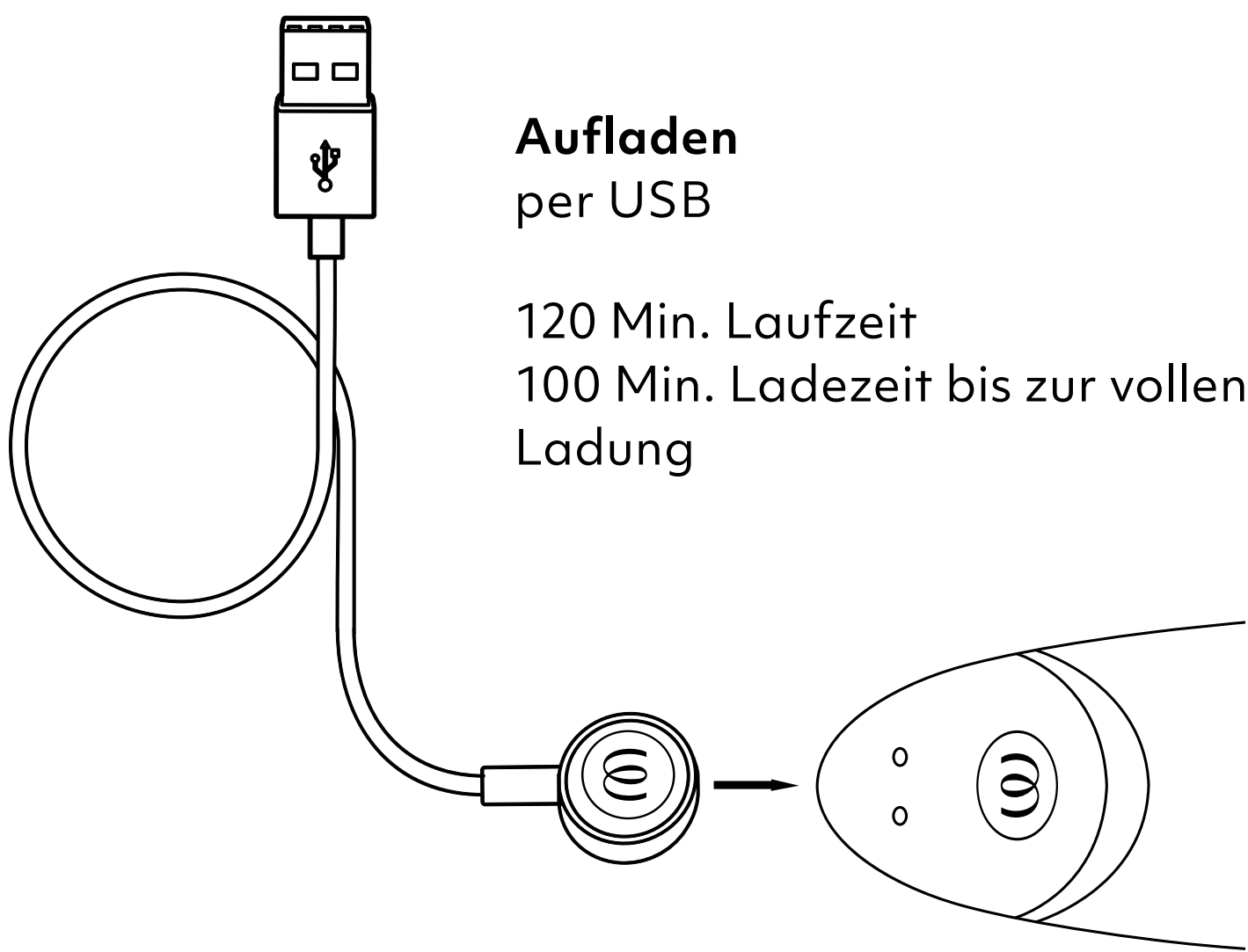

## Aufladen per USB

120 Min. Laufzeit  
100 Min. Ladezeit bis zur vollen  
Ladung

---

## LED

Ein/Aus/Wird geladen

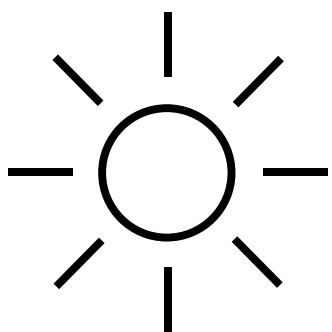

**Das Toy ist vollständig geladen**  
Die LED leuchtet dauerhaft.

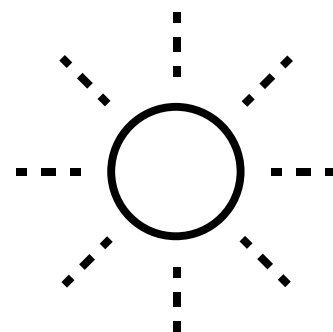

**Aufladen**  
Die LED blinkt.

# EINIGE RAFFINIERTE DETAILS

für maximalen Spaß mit Deinem  
**WOMANIZER OG**



## Der G-Punkt

Das „G“ in G-Punkt geht zurück auf den Physiker Ernst Gräfenberg. Der Name ist zwar geblieben, doch heute wissen wir, dass der G-Punkt nicht wirklich ein „Punkt“ ist. Vielmehr ist er ein größerer Bereich der inneren Klitoris, der von der Innenseite der Vagina aus stimuliert werden kann.

Anders ausgedrückt: Der G-Punkt wird von der vorderen Scheidenwand verdeckt und ist daher weniger empfindlich als die freiliegende äußere Klitoris.

Diese versteckte Lage hat zur Folge, dass der G-Punkt etwas mehr Zeit braucht, um „in Stimmung zu kommen“. Aber mit zunehmender Erregung wird er größer und sensibler und damit empfänglicher für Reize.

Ein G-Punkt-Orgasmus ist ein einzigartiges Erlebnis. Er braucht etwas Zeit und viel Zuwendung, ist dann aber umso intensiver – ganz anders als alles, was Du bisher erlebt hast.

# JOURNEY

Lass Dir Zeit und bleib neugierig.

Trage etwas Gleitmittel auf Wasserbasis auf die Oberfläche des **OG** auf.



Bringe Dich zunächst durch äußere Stimulation mit Pleasure Air in Stimmung.

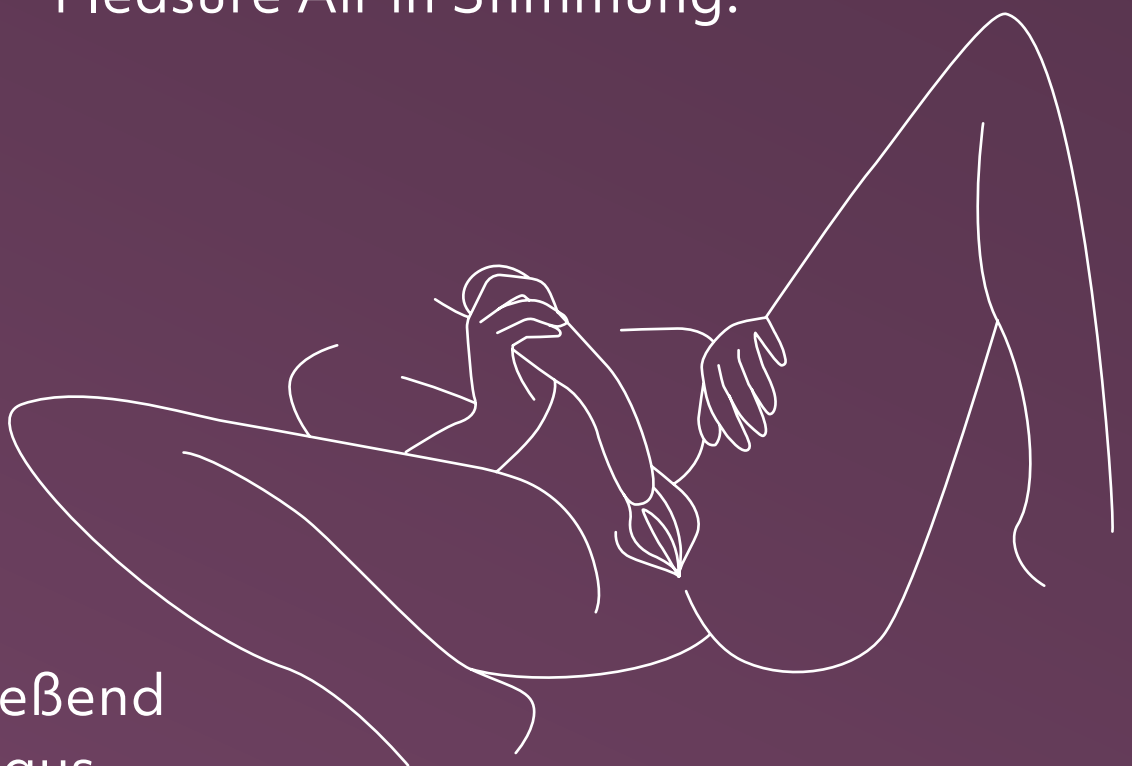
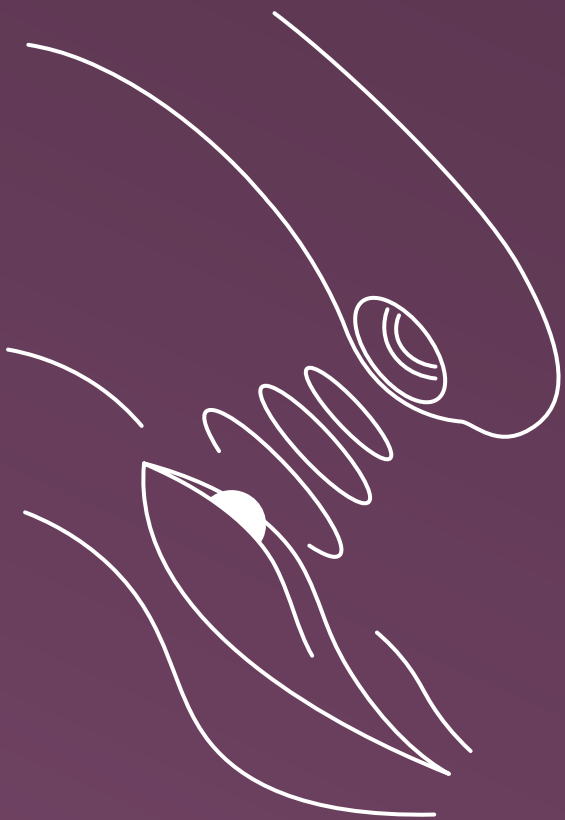

Verwöhne Dich anschließend mit einer Kombination aus interner Pleasure Air Stimulation und Vibrationen.



**OG** kombiniert die Pleasure Air Stimulation mit intensiven Vibrationen. Probiere verschiedene Intensitätsstufen und Vibrationsmodi aus und mach dich auf Deine ganz individuelle **OG**-Reise zu einem atemberaubenden Orgasmus.

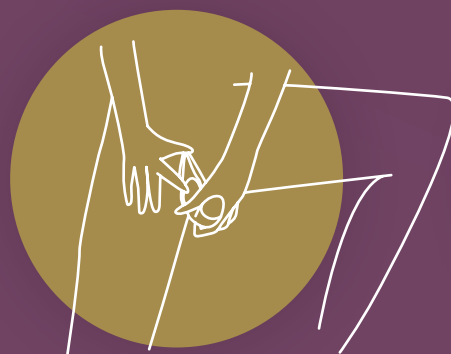
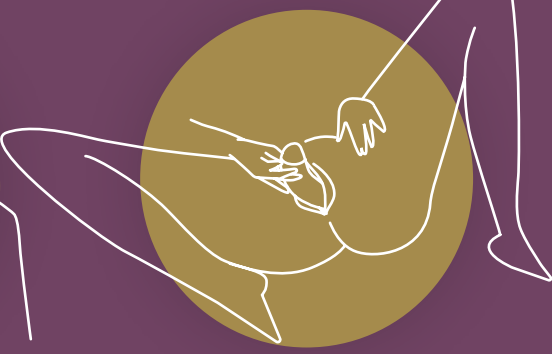
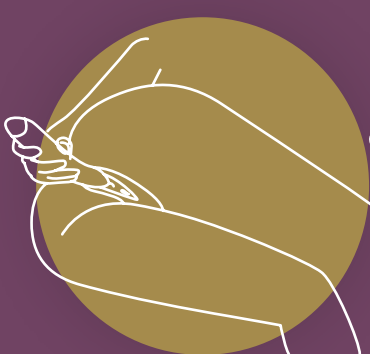

# SAFETY INSTRUCTIONS

## WARNUNG

Dieses Produkt wird als Produktneuheit verkauft. Verwenden Sie das Produkt ausschließlich bestimmungsgemäß. Halten Sie das Produkt von Kindern fern. Nicht für medizinische Zwecke geeignet. Wenn Sie sich in ärztlicher Obhut befinden und/ oder unter einer Krankheit leiden, die die Verwendung eines Medizinproduktes erfordert, konsultieren Sie bitte Ihren Arzt, bevor Sie dieses Produkt verwenden. Stellen Sie die Anwendung des Produkts sofort ein, wenn Hautreizungen, Schmerzen oder Beschwerden auftreten, und wenden Sie sich an Ihren Arzt.

Das Produkt darf nur von Erwachsenen verwendet werden. Personen mit eingeschränkten physischen, sensorischen oder geistigen Fähigkeiten sowie Personen, denen es an Erfahrung oder Kenntnissen fehlt, dürfen das Produkt nur benutzen, wenn sie in die sichere Bedienung des Produktes eingewiesen und über die bestehenden Gefahren unterrichtet wurden. Das Produkt ist kein Spielzeug für Kinder. Kinder dürfen das Produkt nicht reinigen oder pflegen. Wenden Sie das Produkt nicht auf geschwollenen oder entzündeten Hautpartien an.

- Entfernen Sie Piercings oder Schmuck im Intimbereich vor dem Gebrauch.
- Reinigen Sie das Produkt vor und nach dem Gebrauch immer gemäß den Anweisungen im Handbuch.
- Um eine Beschädigung des Produkts zu vermeiden, dürfen Sie das Produkt und seine Batterie keinen Temperaturen über 45°C aussetzen, demontieren oder mechanisch oder elektrisch beschädigen.
- Über Sexspielzeuge können Geschlechtskrankheiten übertragen werden. Teilen Sie Ihre Sexspielzeuge daher nur mit dem Partner. Verwenden Sie beim Sex mit einem Partner gegebenenfalls Schutzmaßnahmen.
- Verwenden Sie das Spielzeug nicht, wenn die Außenhülle Risse oder andere Anzeichen von Beschädigungen aufweist.
- Dieses Produkt ist nicht für den Analbereich geeignet. Verwenden Sie es nicht anal!
- Legen Sie das Produkt nicht mit der weichen Seite auf einer saugfähigen Fläche ab, um Flecken zu vermeiden.
- Überprüfen Sie das Ladegerät und das Produkt regelmäßig auf Beschädigungen und verwenden Sie das Gerät nicht, wenn Komponenten beschädigt sind.
- Magnetfelder können mechanische und elektronische Komponenten wie z.B. Herzschrittmacher beeinflussen. Verwenden Sie das Gerät nicht direkt über dem Herzschrittmacher. Kontaktieren Sie für weitere Informationen Ihren behandelnden Arzt. Bringen Sie keine Karten mit Magnetstreifen (z.B. Kreditkarten) in die Nähe des Geräts, die diese durch den am Produkt befindlichen Magneten beschädigt werden können.
- Wenn Ihr Produkt nicht richtig funktioniert, schalten Sie es aus und konsultieren Sie den Support-Bereich auf unserer Website.

## LADEN

- Überprüfen Sie vor dem ersten Gebrauch des Ladegeräts die Spannung im örtlichen Stromnetz, da diese die am Gerät angegebene maximale Netzspannung nicht überschreiten darf.
- Das Produkt darf nur mit Schutzkleinspannung betrieben werden, wie auf der Kennzeichnung am Produkt angegeben.
- Benutzen oder Reinigen Sie das Produkt nicht, während die Batterie aufgeladen wird.
- Tauchen Sie das Ladegerät oder das Ladekabel niemals in Wasser oder andere Flüssigkeiten.
- Das Produkt enthält nicht austauschbare Batterien/Akkus.
- Dieses Produkt enthält einen Lithium-Ionen-Akku.
- Trennen Sie nach jedem Ladevorgang das Ladekabel vom Stromkreis.



## **BEFOLGEN SIE FÜR EINE OPTIMALE VERWENDUNG DES PRODUKTS DIE FOLGENDEN RICHTLINIEN:**

- Laden Sie das Produkt regelmäßig auf, auch wenn es nicht verwendet wird, um eine lange Akkulaufzeit zu gewährleisten.
- Verwenden Sie zum Aufbewahren einen sicheren, trockenen Ort, der vor direktem Sonnenlicht geschützt ist.
- Wir empfehlen die Verwendung eines Gleitmittels auf Wasserbasis für Ihr Produkt. Verwenden Sie keine parfümierten Gleitmittel, Gele oder Massageöle auf Silikon- oder Alkoholbasis, um Schäden am Produkt zu vermeiden.

## **HINWEISE ZU BATTERIEN**

Aufgrund europäischer Vorschriften sind wir zu folgenden Hinweisen verpflichtet:

- Batterien und Akkus dürfen nicht im Hausmüll entsorgt werden. Als Endnutzer sind Sie zur Rückgabe von Altbatterien gesetzlich verpflichtet. Nutzen Sie dafür die offiziellen Rücknahmestellen wie etwa die Sammelstellen öffentlich-rechtlicher Entsorgungsträger. Altbatterien, die wir als Neubatterie führen oder geführt haben, können Sie auch bei uns zurückgeben. Bitte kontaktieren Sie uns hierzu unter [care@womanizer.com](mailto:care@womanizer.com). Zur Vermeidung von Kurzschlüssen sollten die Pole von Lithium-Batterien vor der Rückgabe verklebt werden. Aus Sicherheitsgründen möchten wir Sie bitten, die Batterien nicht postalisch an uns zu versenden und verweisen dazu auf die Regelungen zum Versand von Gefahrgut von Postunternehmen.
- Sofern die Batterien in dem Produkt fest verbaut sind, versuchen Sie bitte auf keinen Fall, die Batterien selbst auszubauen. Hierdurch kann das Gerät dauerhaft beschädigt werden. Ihre Pflichten als Kunde richten sich im Übrigen nach der WEEE-Richtlinie und dem nationalen Umsetzungsgesetz.
- Zur Abfallvermeidung und zur Vermeidung von Vermüllung sollten die Hinweise in der Anleitung und die Sicherheitshinweise beachtet werden.
- Altbatterien enthalten Schadstoffe, die bei nicht sachgemäßer Lagerung oder Entsorgung die Umwelt oder Ihre Gesundheit schädigen können. Dies betrifft insbesondere den nicht sachgemäßen Umgang mit lithiumhaltigen Batterien. Batterien enthalten aber auch wichtige Rohstoffe wie z.B. Eisen, Zink, Mangan oder Nickel und können verwertet werden. Die getrennte Sammlung ermöglicht die Wiederverwertung dieser Rohstoffe und vermeidet negative Auswirkungen freiwerdender Schadstoffe auf die Umwelt und die menschliche Gesundheit.
- Das Zeichen mit der durchgekreuzten Abfalltonne bedeutet, dass Sie Batterien und Akkus nicht im Hausmüll entsorgen dürfen.

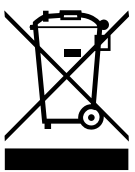

Unter diesem Zeichen müssen bei Vorliegen der gesetzlichen Voraussetzungen nachstehende Symbole mit folgender Bedeutung bei der Kennzeichnung der Batterien verwendet werden:

- Hg: Batterie enthält mehr als 0,0005 Masseprozent Quecksilber
- Pb: Batterie enthält mehr als 0,004 Masseprozent Blei
- Cd: Batterie enthält mehr als 0,002 Masseprozent Cadmium

## **HINWEISE ZUR ENTSORGUNG VON ELEKTROGERÄTEN**

Aufgrund europäischer Vorschriften sind wir zu folgenden Hinweisen verpflichtet:

- Wir weisen Besitzer von Elektrogeräten darauf hin, dass Elektroaltgeräte gemäß den geltenden gesetzlichen Vorschriften einer vom Siedlungsabfall getrennten Erfassung zuzuführen sind. Batterien und Akkumulatoren, die nicht fest vom Elektroaltgerät umschlossen sind, sowie Lampen, die zerstörungsfrei aus dem Altgerät entnommen werden können, sind vor dessen Abgabe an einer Erfassungsstelle zerstörungsfrei von diesem zu trennen und einer vorgesehenen Entsorgung zuzuführen. Für die Entsorgung von Batterien beachten Sie bitte die gesonderten Hinweise. Das nachfolgend dargestellte und auf Elektroaltgeräten aufgebrachte Symbol einer durchgestrichenen Abfalltonne weist zusätzlich auf die Pflicht zur getrennten Erfassung hin:





- Nach der WEEE-Richtlinie und dem nationalen Umsetzungsgesetz sind wir als Vertreiber von Elektrogeräten verpflichtet, bestimmte Elektroaltgeräte unentgeltlich zurückzunehmen.
- Bei Erwerb eines neuen Elektro- und Elektronikgeräts können Sie uns ein Elektroaltgerät, das im Wesentlichen die gleichen Funktionen wie das neue Gerät erfüllt, kostenlos übergeben. Sofern Ihr Elektroaltgerät in keiner Abmessung größer als 25 Zentimeter ist, können Sie uns dieses ohne Erwerb eines neuen Geräts ebenfalls kostenlos übergeben. Bitte kontaktieren Sie uns hierzu unter [care@womanizer.com](mailto:care@womanizer.com). Wir werden dann die Rückführung des Elektroaltgeräts organisieren. Aus Sicherheitsgründen möchten wir Sie bitten, auf den Versand von Beleuchtungskörpern (etwa Lampen) zu verzichten. Bitte nutzen Sie für eine Rückgabe von Beleuchtungskörpern die Sammelstellen der öffentlich-rechtlichen Entsorgungsträger oder kontaktieren Sie uns unmittelbar unter der vorgenannten E-Mail-Adresse.
- Daneben können Sie Elektroaltgeräte auch an allen Sammelstellen der öffentlich-rechtlichen Entsorgungsträger abgeben. Sie leisten einen wichtigen Beitrag zur Wiederverwendung, zum Recycling und zur sonstigen Verwertung von Altgeräten, dadurch dass Sie Ihre Elektroaltgeräte einer getrennten Erfassung in den richtigen Sammelgruppen zuführen.
- Für die Löschung personenbezogener Daten auf den zu entsorgenden Elektroaltgeräten sind Sie als Endnutzer vor der Abgabe selbst verantwortlich.
- Zur Abfallvermeidung sollten die Hinweise in der Anleitung und die Sicherheitshinweise beachtet, sowie Reparaturmöglichkeiten geprüft, werden.

# GENERAL INFORMATION

## ELECTRICAL RATING

**Model:** OG

**Model No.:** TES10A

**Power Input:**

3,7 V=0,62 A: Built-in Li-Polymer rechargeable battery.

5 V=0,5 A: When charged using USB.

Use USB AC adaptor (not included) with power output corresponding to product rating. Use original provided cable only."

## CONTENT OF DELIVERY

Womanizer OG G-Spot vibrator, USB charging cable (AC adapter not included), cotton storage pouch, quick start guide, safety instructions

## ENVIRONMENTAL PROTECTION

As a distributor of electronic devices, we are legally obliged to accept the return of waste electrical and electronic devices free of charge. We expressly state that you as the user are legally obliged to return used batteries.

Never throw away electronic devices or batteries in the household waste. The symbol shown below (crossed-out wheeled bin) is intended to expressly remind you of this.

## MANUFACTURED AND DISTRIBUTED BY

**WOW Tech Europe GmbH**

Hermann-Blankenstein-Strasse 5

10249 Berlin

[www.wowtech.com](http://www.wowtech.com)

WOW Tech Europe GmbH reserves the right to make technical changes and changes to the design that serve to improve the device.

For information regarding patents see [womanizer.com/patents](http://womanizer.com/patents).

## CUSTOMER CARE

[care@womanizer.com](mailto:care@womanizer.com)

[womanizer.com](http://womanizer.com)

Designed in Germany. Made in China.

Date of issue: 10/2022.



# DU MÖCHTEST NOCH MEHR?

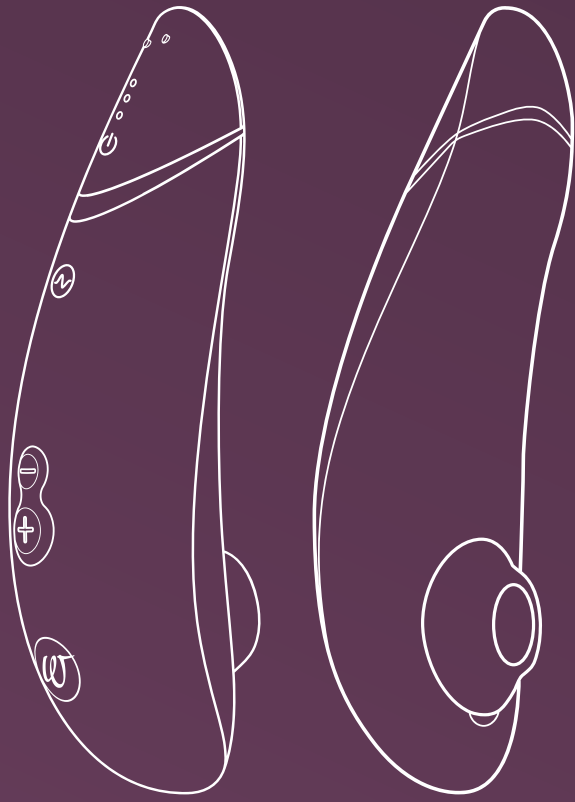

Pleasure Air  
Technology

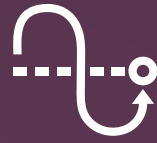

Autopilot



Smart Silence

**Premium 2**  
Define your luxury

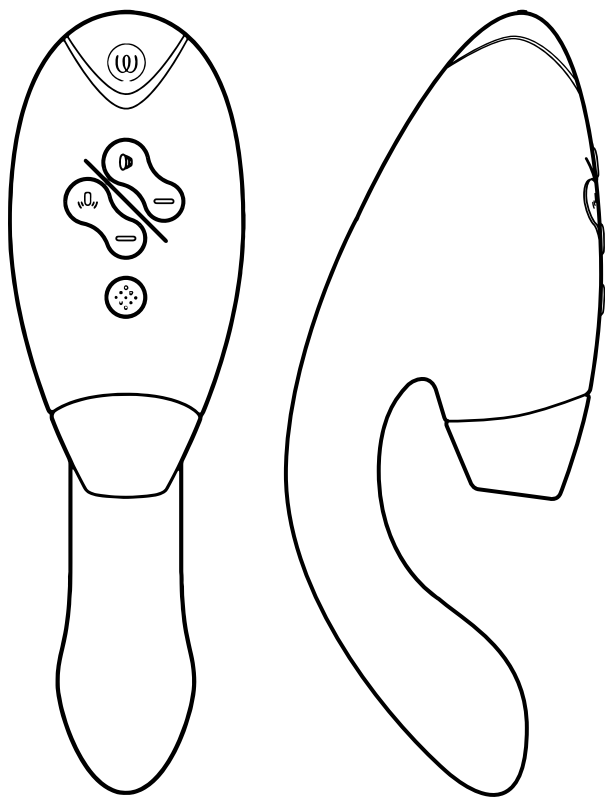

Pleasure Air  
Technology



Double Stimulation



Smart Silence

**DUO 2**  
Indulge in whole-body orgasms



#IMASTURBATE

# Hi!

Gracias por haber elegido **WOMANIZER OG**.

Te damos la bienvenida en un mundo lleno de experiencias sensuales que enriquecerán tu vida. Con la elección de **WOMANIZER**, no solo se te garantizan orgasmos incomparables, sino también una sensación de placer completamente nueva.

Disfruta con tu **WOMANIZER OG** de un orgasmo detrás de otro.

¡Vamos, quíete a tí mismo!



**DESCRIPCIÓN**

**UTILIZACIÓN**

**SMART SILENCE**

**LIMPIEZA**

**CARGA**

**UNOS CONSEJOS**

**SAFETY INSTRUCTIONS**

**INFORMACIÓN GENERAL**

Please read the safety instructions in the  
Compliance & Safety Information before first use.

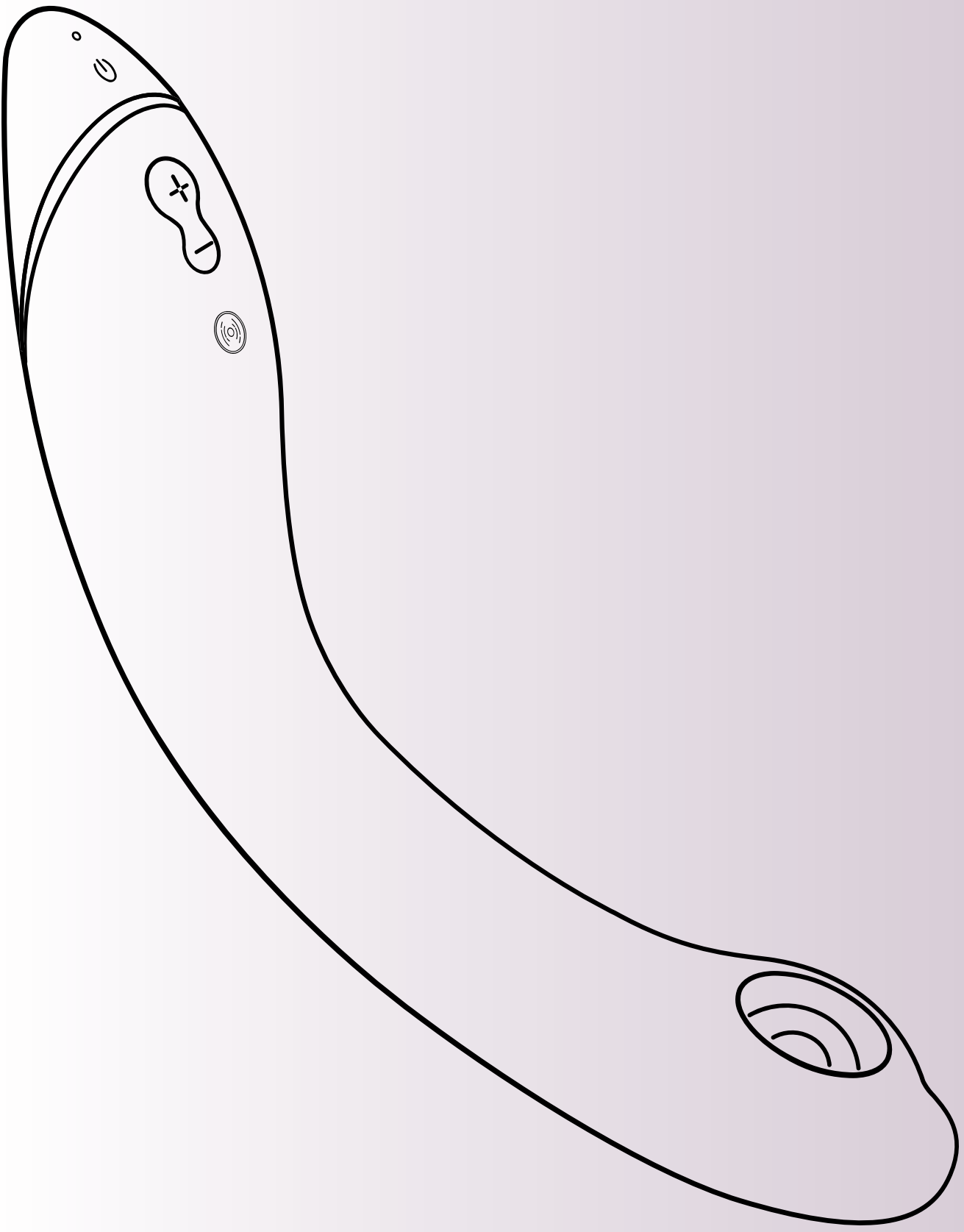

# DESCRIPCIÓN

**Pantalla LED**  
Encendido/carga

**Activar/desactivar  
Smart Silence**  
Pulsar durante  
2 segundos

**Vibración**  
Pulsar brevemente  
para activar y  
aumentar la  
intensidad  
(3 niveles)

**Pleasure Air Technology**  
(12 niveles)

**Encendido/apagado**  
Pulsar durante 2 segundos

**Aumentar la intensidad**  
Pulsar (+) brevemente

**Reducir la intensidad**  
Pulsar (-) brevemente

**Afterglow**  
Pulsar (-) durante 1  
segundo





# UTILIZACIÓN

## 1. Encendido

Pulsar durante 2 segundos.  
El LED indicará que el producto  
está encendido.

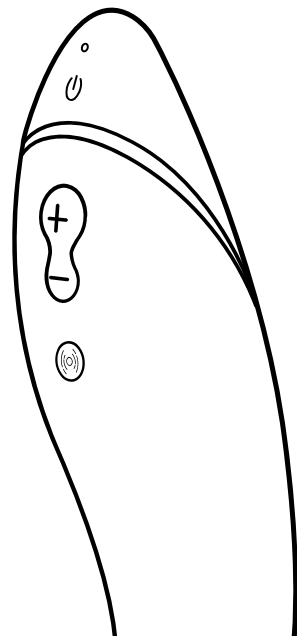

## 2. Utilización

Para ponerte en situación,  
usa **OG** primero en el clítoris.

Añade lubricante de base  
acuosa al cuerpo de **OG**.

¡Una vez excitada, inserta  
**OG** y explora tu punto G!

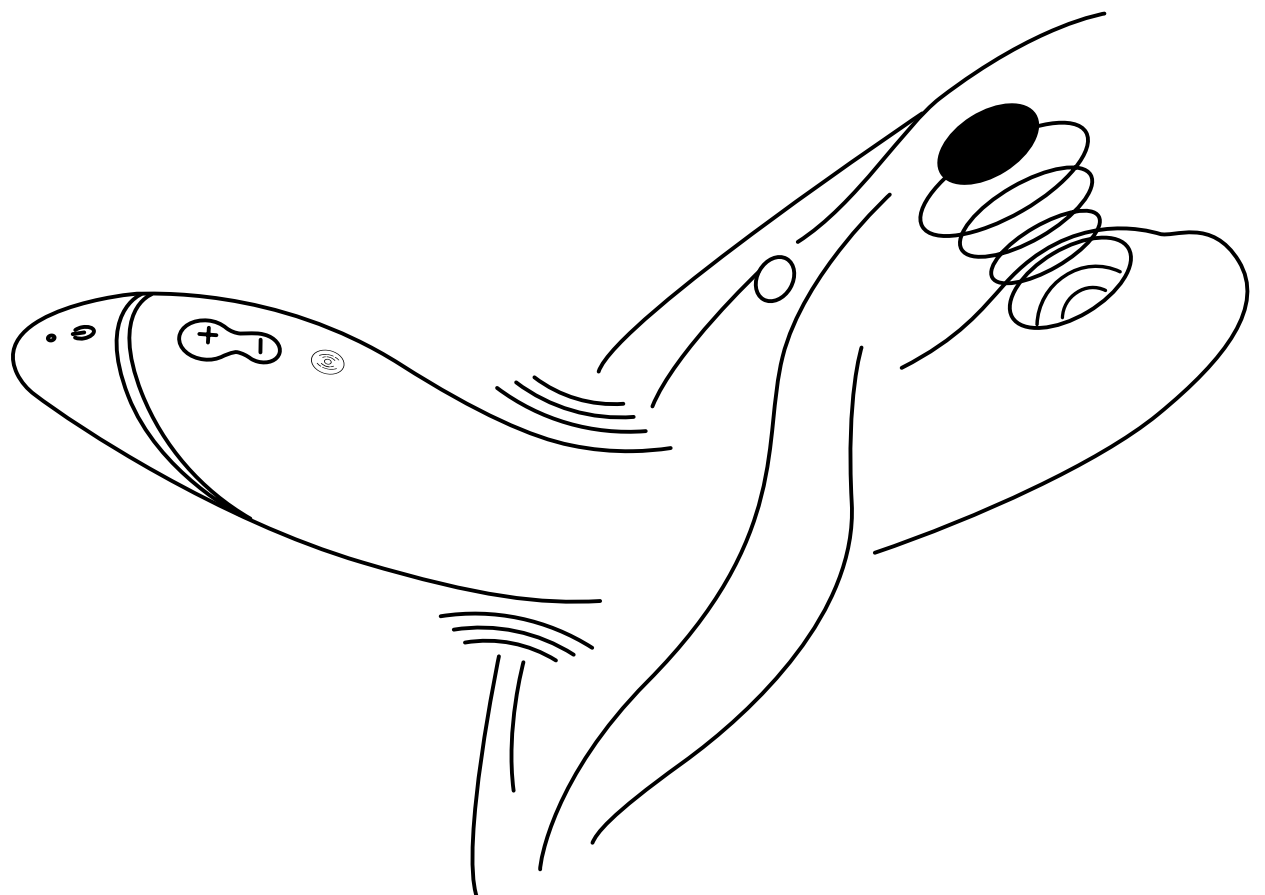
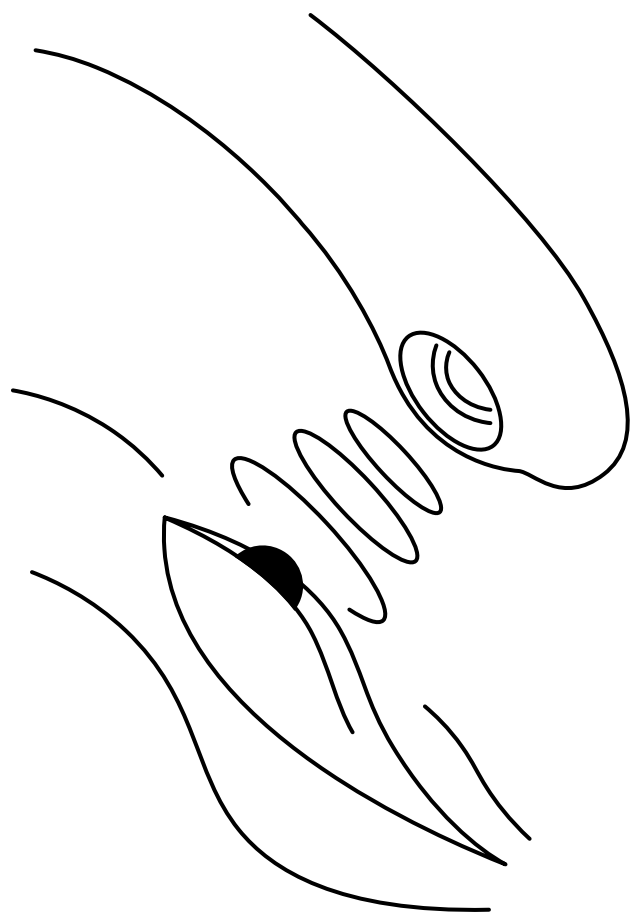

# UTILIZACIÓN

## 3. Cambio de intensidad

### Aumentar

Pulsar brevemente

**12 niveles de intensidad**

### Aumentar

Pulsar brevemente

**3 niveles de vibración**

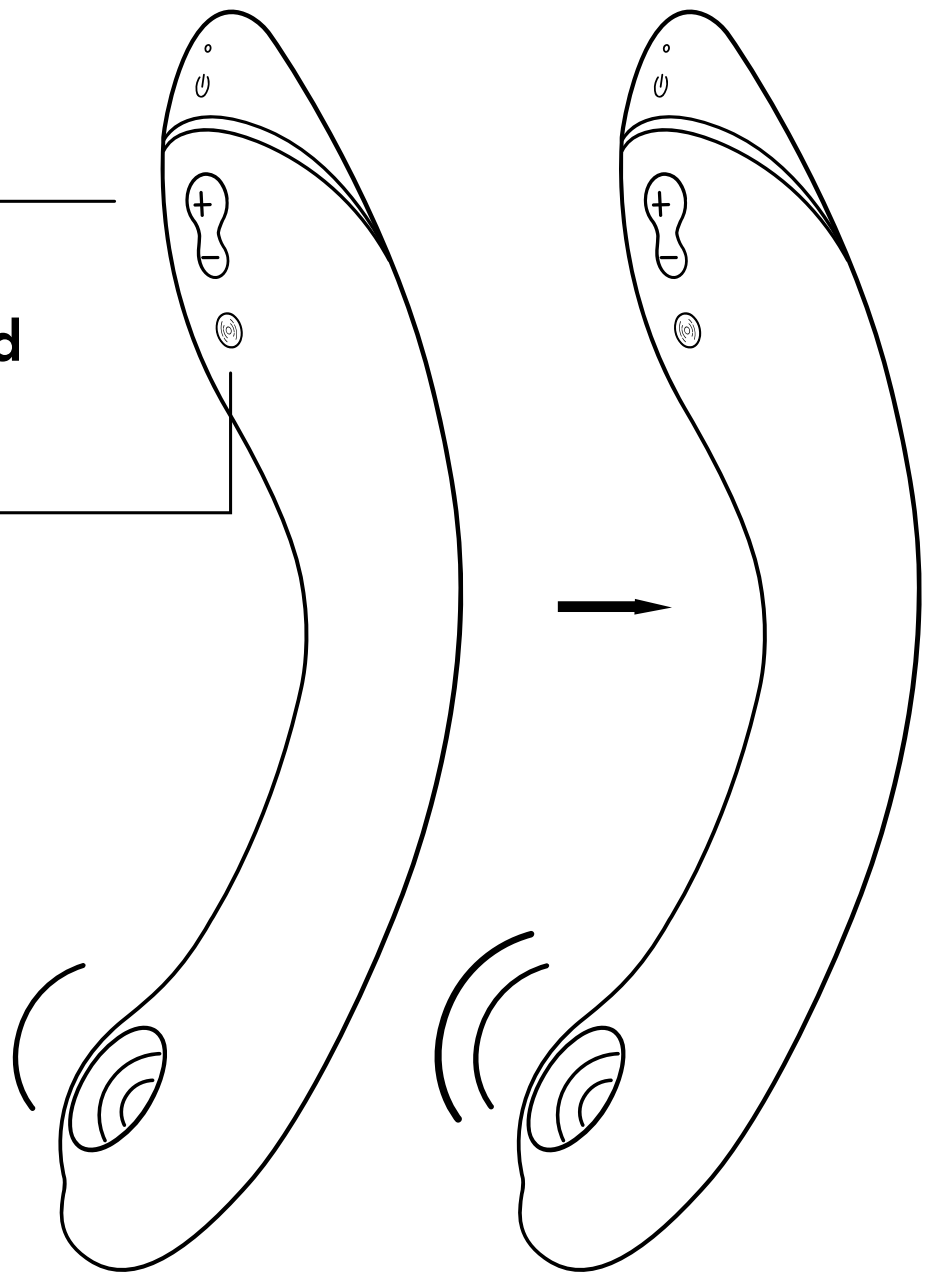

### Reducir

Pulsar brevemente

### Afterglow

Pulsar (-) durante un segundo para volver al nivel 1 de intensidad

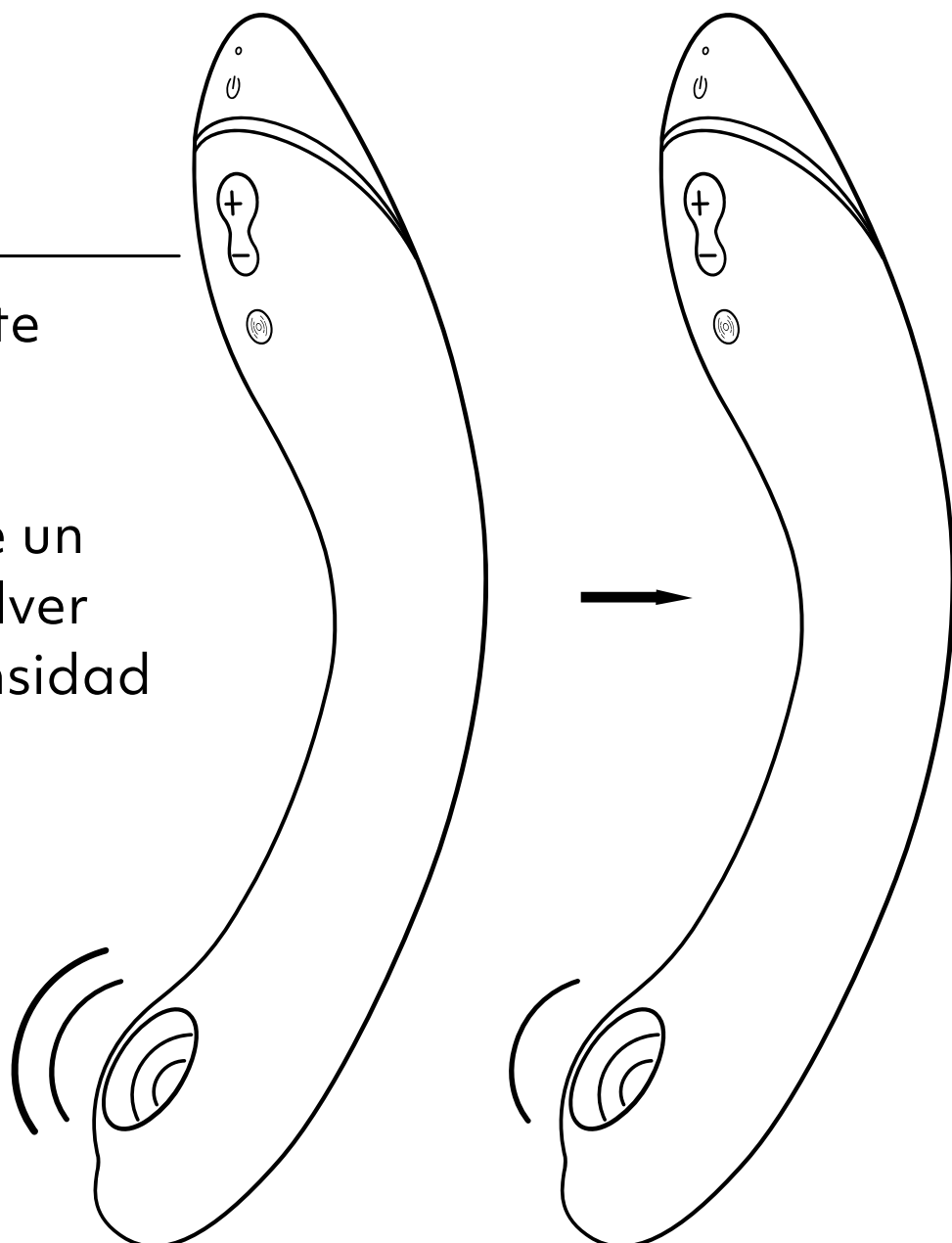

# UTILIZACIÓN

4. **Apagado** •  
Pulsar durante 2 segundos

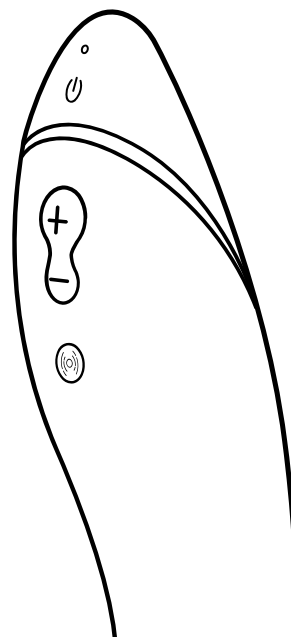

## SMART SILENCE

**OG** solo se enciende cuando está casi tocando tu piel. El Smart Silence estará activado por defecto. Mantén pulsados los botones más y menos durante 2 segundos para activar o desactivar el Smart Silence.

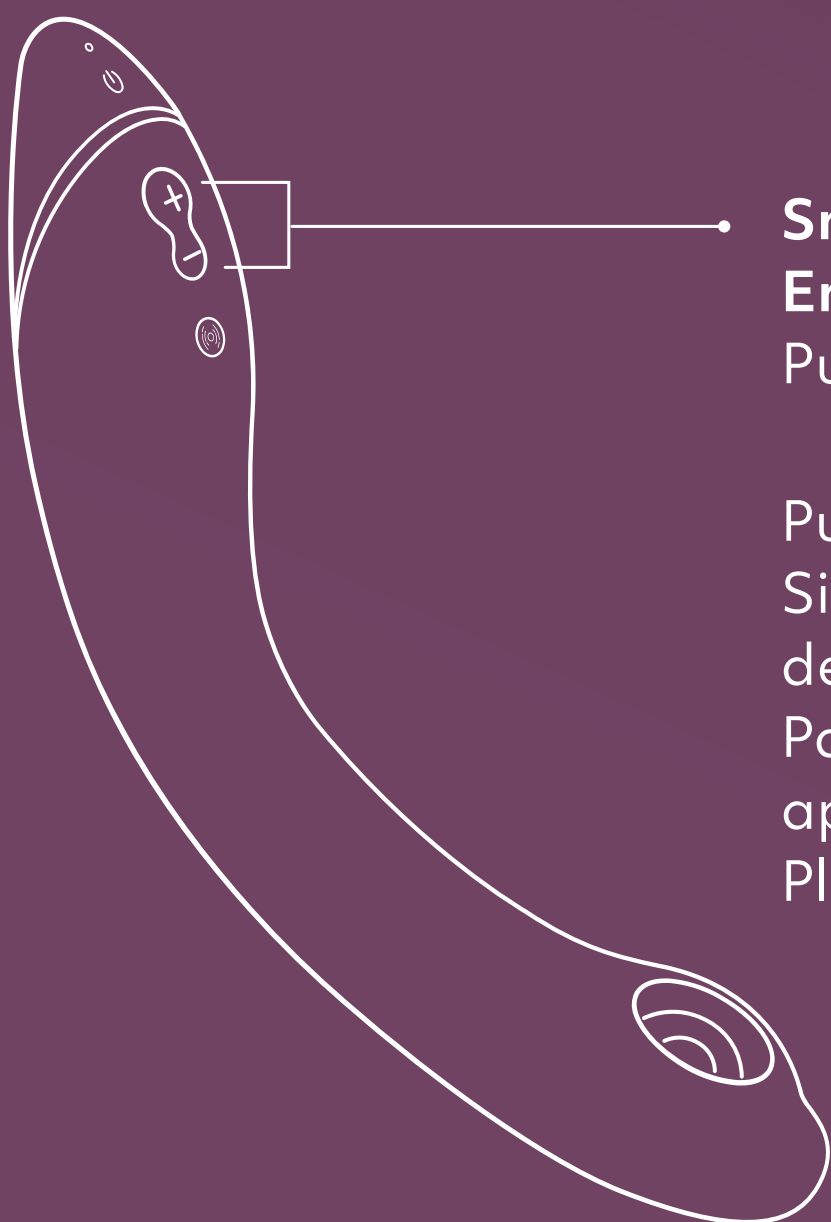

**Smart Silence**  
**Encendido/apagado**  
Pulsar durante 2 segundos

Puede que la función Smart Silence no funcione si el cabezal de estimulación está mojado. Para evitarlo, asegúrate de no aplicar lubricante al cabezal de Pleasure Air.

# LIMPIEZA

Lávalo debajo del agua.

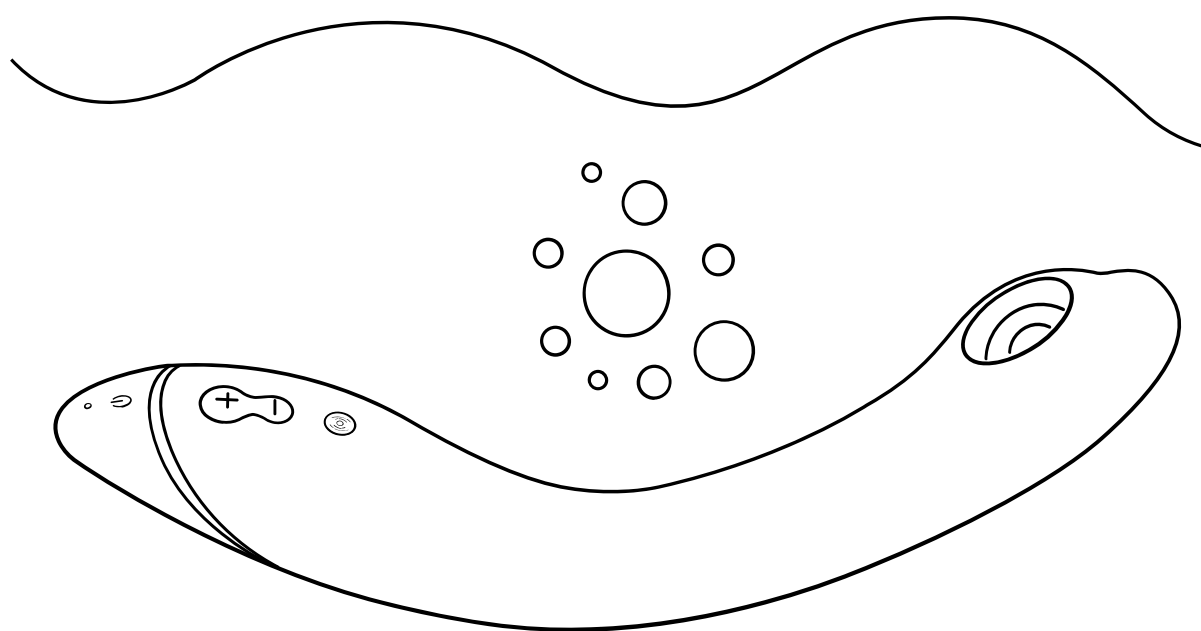

Aplica limpiador de juguetes.

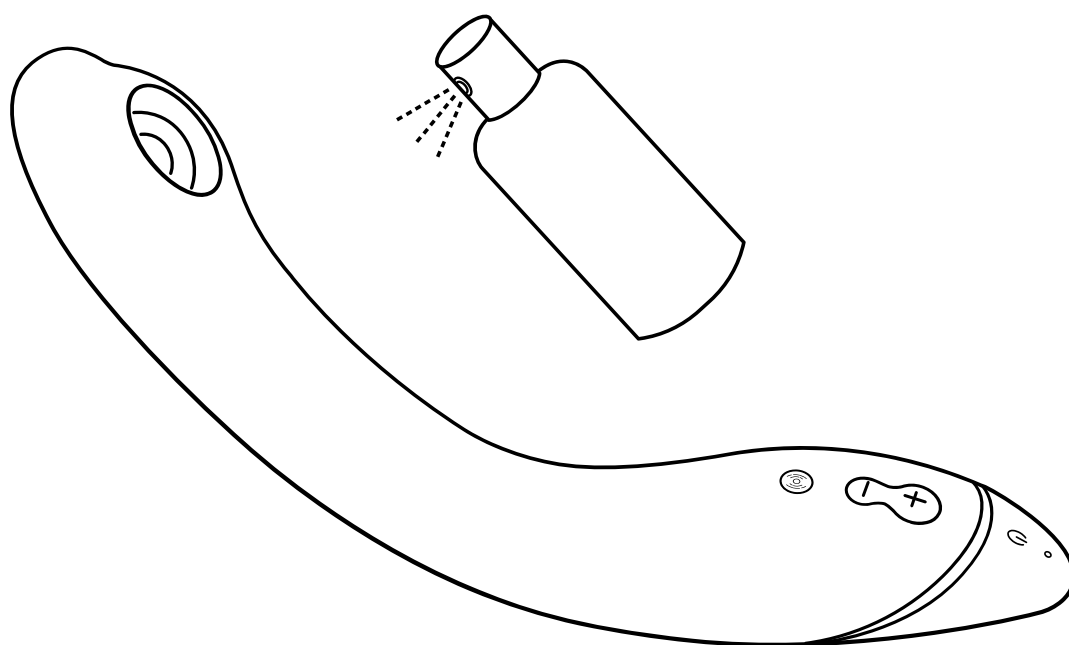

Seca con cuidado sin aplicar demasiada presión a la membrana.

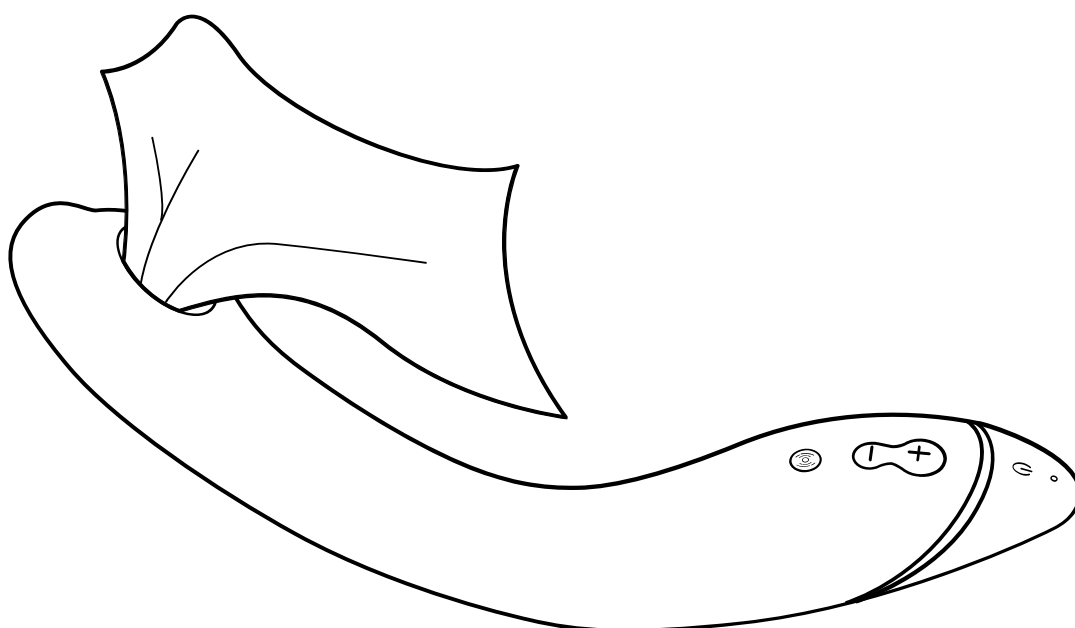

Resistente  
al agua  
(IPX7)

# CARGA

Carga tu **OG** antes de usarlo por primera vez. No olvides recargar tu **OG** con regularidad para garantizar una larga duración de la batería.

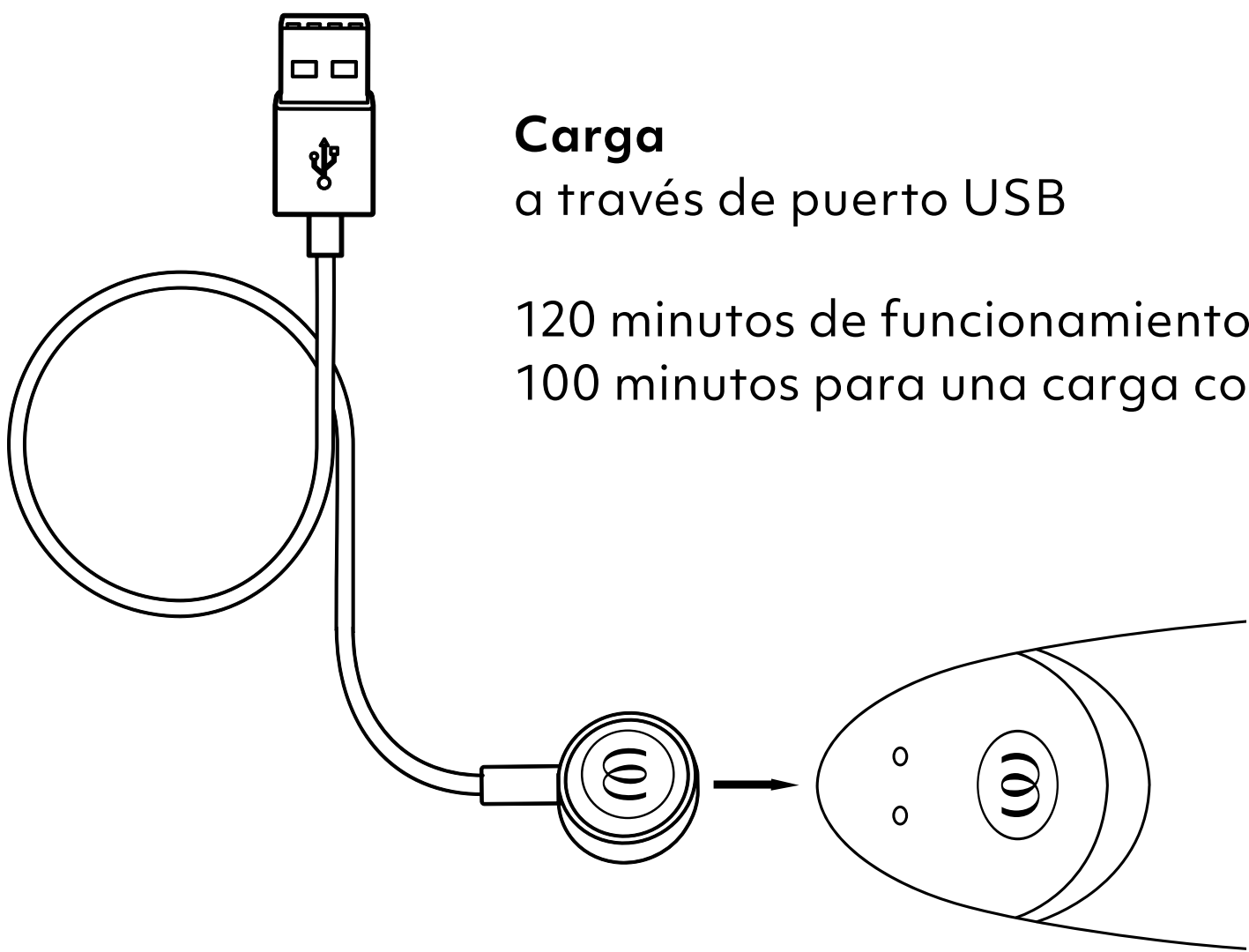

## Carga

a través de puerto USB

120 minutos de funcionamiento

100 minutos para una carga completa

---

## LED

Encendido/apagado/carga

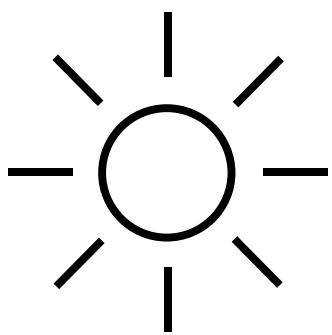

**Completamente cargado**  
El LED se ilumina de forma continua

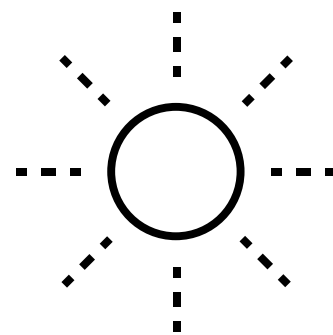

**Carga**  
El LED parpadea

# UNOS CONSEJOS

para sacar todo el partido a  
**WOMANIZER OG**



## El punto G

La «G» del punto G debe su nombre al médico Ernst Gräfenberg. El término ha calado, pero ahora sabemos que el punto G no es un «punto», sino un área de mayor tamaño situada en la cara interna del clítoris que se puede estimular desde el interior de la vagina.

Por lo tanto, la zona del punto G está cubierta por la pared vaginal frontal y es menos sensible que la parte exterior expuesta del clítoris.

Al estar cubierto, el punto G tarda más en excitarse. Aumenta de tamaño y se vuelve más sensible y receptivo a la estimulación con la excitación.

Un orgasmo del punto G es una experiencia única. Para conseguirlo se requiere tiempo y atención, pero el clímax resultante produce una intensa satisfacción y es totalmente diferente a cualquier cosa que hayas experimentado.

# LA EXPERIENCIA

Tómate tu tiempo y aprende a conocerte.

Añade lubricante de base acuosa al cuerpo de **OG**.



Ponte en situación y empieza con una estimulación **Pleasure Air** externa.

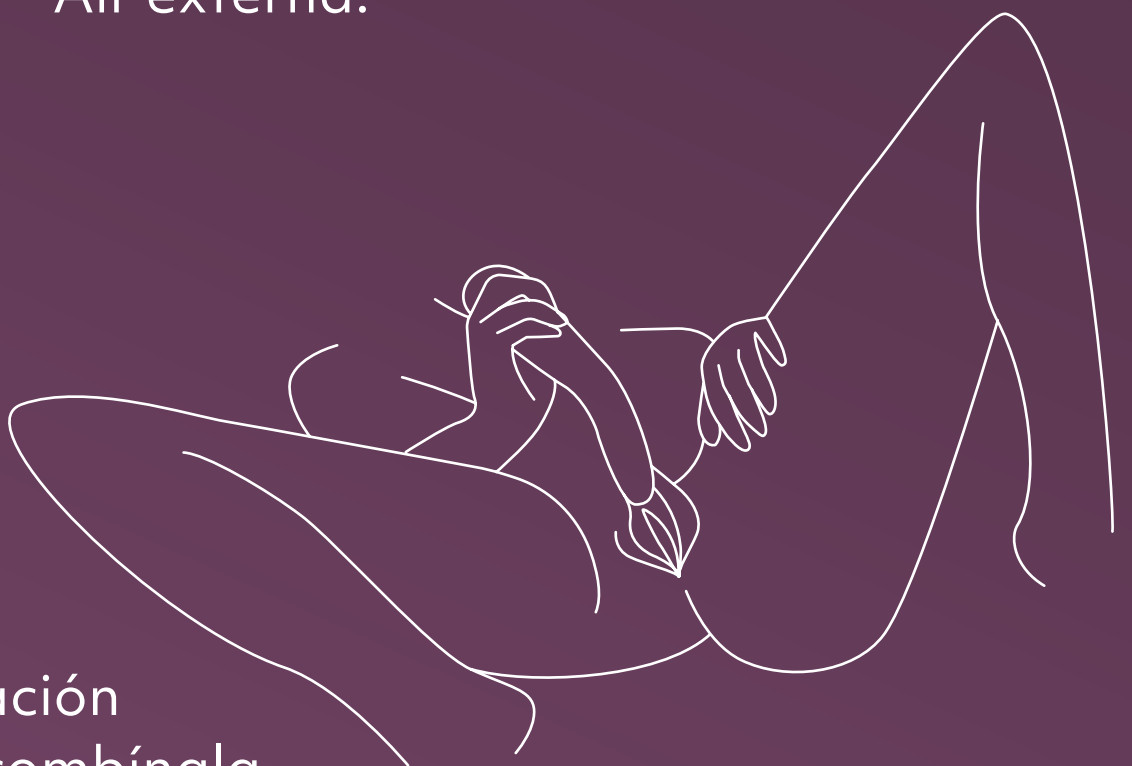

Sigue con una estimulación **Pleasure Air** interna y combínala con vibraciones.



**OG** ofrece una combinación de estimulación **Pleasure Air** y potentes vibraciones. Crea tu viaje orgásmico único probando diferentes intensidades y vibraciones.

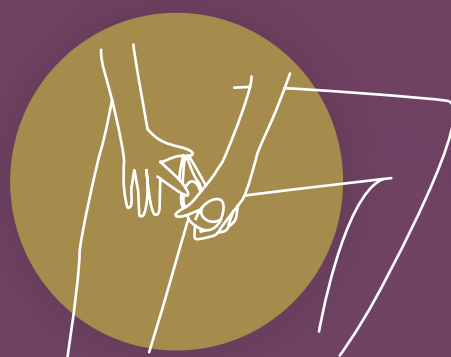
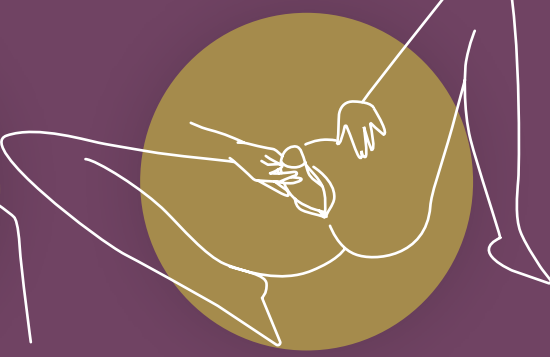
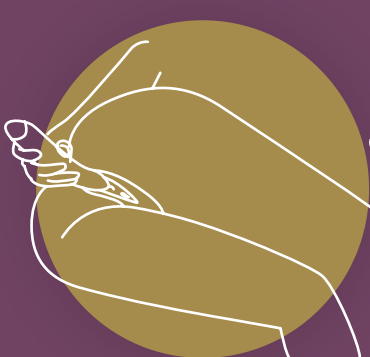



# SAFETY INSTRUCTIONS

## AVISO

Artículo comercializado exclusivamente como producto lúdico. Utiliza el producto únicamente para los fines previstos. Mantén el producto alejado de los niños. No apto para fines médicos. Si estás bajo atención médica y/o padeces una enfermedad que requiere el uso de cualquier dispositivo médico, consulta a tu doctor antes de usar el producto. Deja de utilizar el producto inmediatamente si experimentas irritación cutánea, dolor o malestar y consulta con tu médico.

Este aparato solo pueden utilizarlo adultos y personas con discapacidad física, sensorial o mental o falta de experiencia y conocimiento si cuentan con supervisión o se les facilitan las instrucciones para utilizarlo de forma segura y comprenden los riesgos que entraña. Los niños no deben jugar con el aparato. Los niños no deben encargarse de la limpieza y el mantenimiento del aparato. No utilices el aparato en zonas hinchadas o inflamadas de la piel.

- Retira cualquier piercing o joya en el área íntima antes de su uso.
- Limpia siempre el producto antes y después de utilizarlo siguiendo las instrucciones del manual.
- Para evitar daños en el producto, ni el producto ni su batería deben exponerse a temperaturas superiores a 45 °C, desmontarse o dañarse mecánica o eléctricamente.
- Compartir juguetes sexuales puede conllevar el contagio de enfermedades de transmisión sexual. No compartas tus juguetes sexuales con una persona distinta a tu pareja. Utiliza medidas de protección con tu pareja si es necesario. No utilices el juguete si detectas grietas o signos de degradación en el material de la carcasa.
- Este producto no se ha diseñado para su uso anal. ¡No lo utilices en penetración anal!
- No coloques la parte blanda del producto en una superficie absorbente para evitar la aparición de manchas.
- Comprueba con regularidad si existen daños en el cargador y en el juguete y no utilices el dispositivo si algún componente está dañado.
- Los campos magnéticos pueden influir en componentes mecánicos y electrónicos como, p. ej., marcapasos. No utilices el producto directamente sobre el marcapasos. Ponte en contacto con el médico responsable de tu tratamiento para obtener más información. No coloques tarjetas con banda magnética (p. ej., tarjetas de crédito) cerca del producto, ya que pueden dañarse debido al imán del producto.
- Si parece que el juguete no funciona con normalidad, apágalo y consulta el apartado de asistencia técnica de nuestra web.

## CARGA

- Antes de utilizar por primera vez el dispositivo de carga, comprueba el nivel de tensión, ya que la tensión de la red eléctrica local no puede superar la tensión máxima del dispositivo de carga.
- Este aparato solo puede suministrarse con un nivel de tensión extrabajo de seguridad de acuerdo con el marcado del mismo.
- No utilices ni limpies el producto mientras la batería se está cargando.
- Nunca sumerjas el dispositivo o cable de carga en agua u otros fluidos.
- Este aparato contiene baterías que no son reemplazables.
- Este producto contiene una batería recargable de iones de litio.
- Desconecta el cable de carga de la fuente de alimentación después de cada proceso de carga.

## PARA UTILIZAR EL PRODUCTO DE FORMA ÓPTIMA, SIGUE ESTAS INDICACIONES:

- Para garantizar una larga vida útil de la batería, carga el dispositivo habitualmente, aunque no se utilice.
- Guárdalo en un lugar seco y seguro sin exposición directa a la luz solar.
- Recomendamos utilizar un lubricante a base de agua con el juguete. Para evitar que se dañe, no utilices lubricantes perfumados, a base de silicona o alcohol, geles o aceites de masaje..

## INFORMACIÓN SOBRE BATERÍAS

Debido a la normativa europea, estamos obligados a facilitar la siguiente información:

- Las pilas y baterías recargables no deben desecharse en la basura doméstica. Como usuario final, usted tiene la obligación legal de devolver las pilas usadas. Utilice los puntos de recogida oficiales para este fin, como los puntos de recogida de las autoridades públicas de eliminación



de residuos. También puede devolvernos las pilas usadas que vendemos o hemos vendido como pilas nuevas. Para ello, puede contactar con nosotros en [care@womanizer.com](mailto:care@womanizer.com). Para evitar cortocircuitos, los terminales de las pilas de litio deben cubrirse con cinta adhesiva antes de devolverlas. Por razones de seguridad, le rogamos que no nos envíe las pilas por correo y le remitimos a las normas de envío de mercancías peligrosas de las empresas de correos.

- En el caso de que las pilas estén instaladas permanentemente en el producto, no intente retirarlas usted mismo. Esto puede causar un daño permanente al dispositivo. Por lo demás, sus obligaciones como cliente se rigen por la Directiva RAEE y la Ley de Transposición Nacional de la misma.
- Con el fin de evitar la formación y acumulación de residuos, deben respetarse las instrucciones del manual y las advertencias de seguridad.
- Las pilas usadas contienen sustancias nocivas que pueden dañar el medio ambiente o su salud si no se almacenan o eliminan adecuadamente. Esto atañe, en particular, a la manipulación inadecuada de las pilas que contienen litio. Sin embargo, las pilas también contienen importantes materias primas como hierro, zinc, manganeso o níquel, y pueden por tanto ser recicladas. La recogida selectiva permite reciclar estas materias primas y evita los efectos negativos de los contaminantes liberados en el medio ambiente y en la salud humana.
- El símbolo del contenedor de basura tachado significa que no debe tirar las pilas y las baterías a los residuos domésticos.



Bajo este distintivo, y siempre que se cumplan todos los requisitos legales, al etiquetar las pilas deben utilizarse los siguientes símbolos con el siguiente significado:

- Hg: La pila contiene más de un 0,0005 por ciento en peso de mercurio
- Pb: La pila contiene más de un 0,004 por ciento en peso de plomo
- Cd: La pila contiene más de un 0,002 por ciento en peso de cadmio

## INFORMACIÓN SOBRE LA ELIMINACIÓN DE APARATOS ELÉCTRICOS

Debido a la normativa europea, estamos obligados a facilitar la siguiente información:

- Recordamos a los propietarios de aparatos eléctricos que, de acuerdo con la normativa legal vigente, los dispositivos eléctricos estropeados deben desecharse por separado de los residuos municipales. Las pilas y las baterías que no se encuentren firmemente instaladas en el aparato eléctrico que se desea desechar, así como las lámparas que puedan extraerse del aparato sin romperse, deben retirarse sin romperlas antes de entregar el aparato eléctrico estropeado en un punto de recogida o de eliminación designado. Para la eliminación de las pilas, consulte las instrucciones especiales. El símbolo del contenedor de basura tachado que se muestra a continuación y que se coloca en los RAEE también indica la obligación de recoger los residuos por separado:

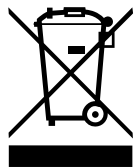

- De acuerdo con la Directiva RAEE y la Ley de Transposición Nacional, nosotros, como distribuidores de dispositivos eléctricos, estamos obligados a recuperar determinados RAEE de forma gratuita.
- Al comprar un nuevo dispositivo eléctrico y electrónico, puede entregarnos gratuitamente un dispositivo eléctrico o electrónico antiguo que cumpla esencialmente las mismas funciones que el nuevo. Si su viejo equipo eléctrico no supera los 25 centímetros en cualquiera de sus dimensiones, también puede entregárnoslo gratuitamente sin necesidad de comprar un nuevo dispositivo. Para ello, puede contactar con nosotros en [care@womanizer.com](mailto:care@womanizer.com). Posteriormente, nos ocuparemos de organizar la devolución del aparato eléctrico desechado. Por razones de seguridad, le rogamos que se abstenga de enviar equipos de iluminación (como lámparas). Le rogamos que utilice los puntos de recogida de las autoridades públicas de gestión de residuos para la devolución de los equipos de iluminación o que se ponga en contacto con nosotros directamente en la dirección de correo electrónico mencionada anteriormente.
- También puede devolver los dispositivos eléctricos que desee desechar en todos los puntos de recogida del servicio público de gestión de residuos. Al eliminar sus aparatos eléctricos y electrónicos en los grupos de recogida específicos para su recogida selectiva, usted contribuye de forma importante a la reutilización, el reciclaje y recuperación de aparatos eléctricos estropeados.
- Como usuario final, usted es responsable de borrar los datos personales de los RAEE antes de desecharlos.
- Con el fin de evitar la formación de residuos, deben seguirse las instrucciones del manual y las advertencias de seguridad, además de comprobar las posibilidades de reparación.

# GENERAL INFORMATION

## ELECTRICAL RATING

**Model:** OG

**Model No.:** TES10A

**Power Input:**

3,7 V=0,62 A: Built-in Li-Polymer rechargeable battery.

5 V=0,5 A: When charged using USB.

Use USB AC adaptor (not included) with power output corresponding to product rating. Use original provided cable only."

## CONTENT OF DELIVERY

Womanizer OG G-Spot vibrator, USB charging cable (AC adapter not included), cotton storage pouch, quick start guide, safety instructions

## ENVIRONMENTAL PROTECTION

As a distributor of electronic devices, we are legally obliged to accept the return of waste electrical and electronic devices free of charge. We expressly state that you as the user are legally obliged to return used batteries.

Never throw away electronic devices or batteries in the household waste. The symbol shown below (crossed-out wheeled bin) is intended to expressly remind you of this.

## MANUFACTURED AND DISTRIBUTED BY

**WOW Tech Europe GmbH**

Hermann-Blankenstein-Strasse 5

10249 Berlin

[www.wowtech.com](http://www.wowtech.com)

WOW Tech Europe GmbH reserves the right to make technical changes and changes to the design that serve to improve the device.

For information regarding patents see [womanizer.com/patents](http://womanizer.com/patents).

## CUSTOMER CARE

[care@womanizer.com](mailto:care@womanizer.com)

[womanizer.com](http://womanizer.com)

Designed in Germany. Made in China.

Date of issue: 10/2022.



# ¿TIENES GANAS DE MÁS?

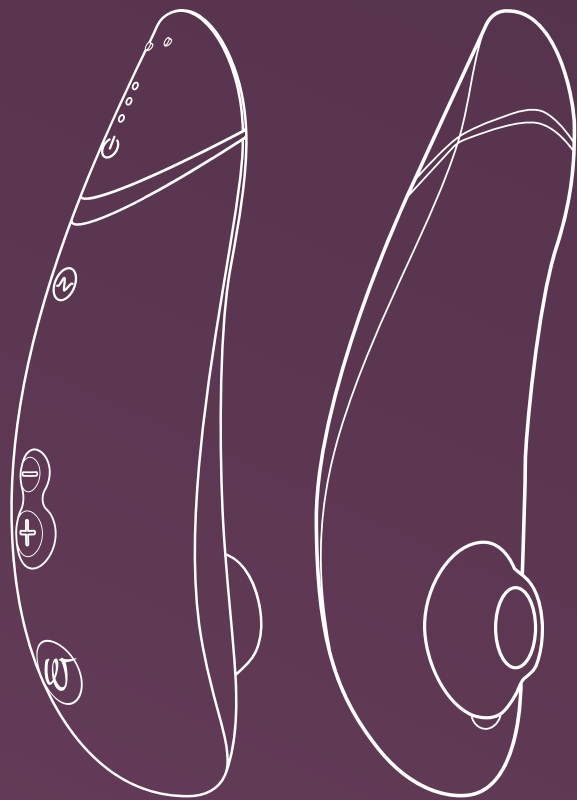

Pleasure Air  
Technology

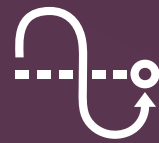

Autopilot



Smart Silence

**Premium 2**  
Define your luxury

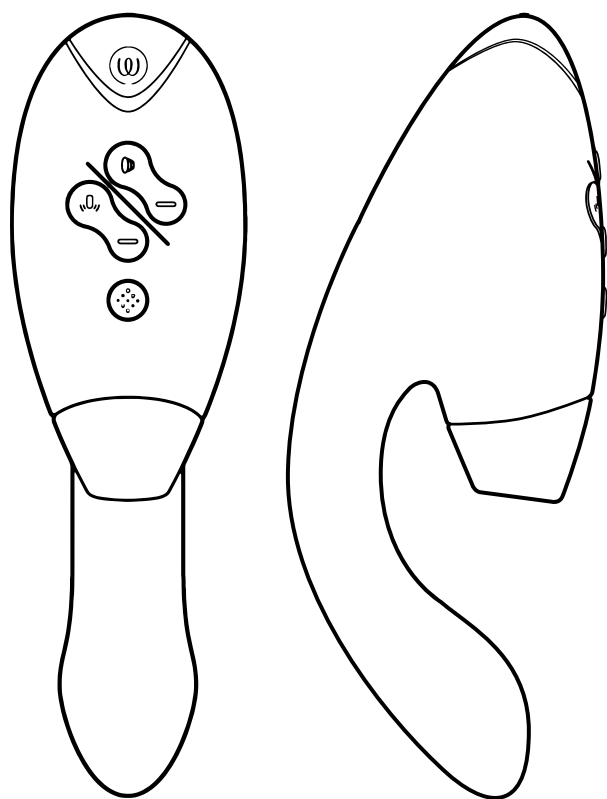

Pleasure Air  
Technology



Double Stimulation

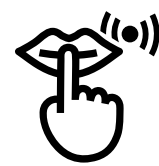

Smart Silence

**DUO 2**  
Indulge in whole-body orgasms



#IMASTURBATE

# Hi!

Bedankt dat je voor **WOMANIZER OG** hebt gekozen.

Welkom in een wereld vol sensuele ervaringen die je leven zullen verrijken. Door te kiezen voor **WOMANIZER** ben je niet alleen verzekerd van ongeëvenaarde orgasmen, maar krijg je ook een totaal nieuw verlangen naar genot.

Met **WOMANIZER OG** beleef je het ene na het andere orgasme.

Geniet van jezelf!



**BESCHRIJVING**

**GEBRUIK**

**SMART SILENCE**

**REINIGEN**

**OPLADEN**

**SAFETY INSTRUCTIONS**

**ALGEMENE INFORMATIE**

Please read the safety instructions in the  
Compliance & Safety Information before first use.

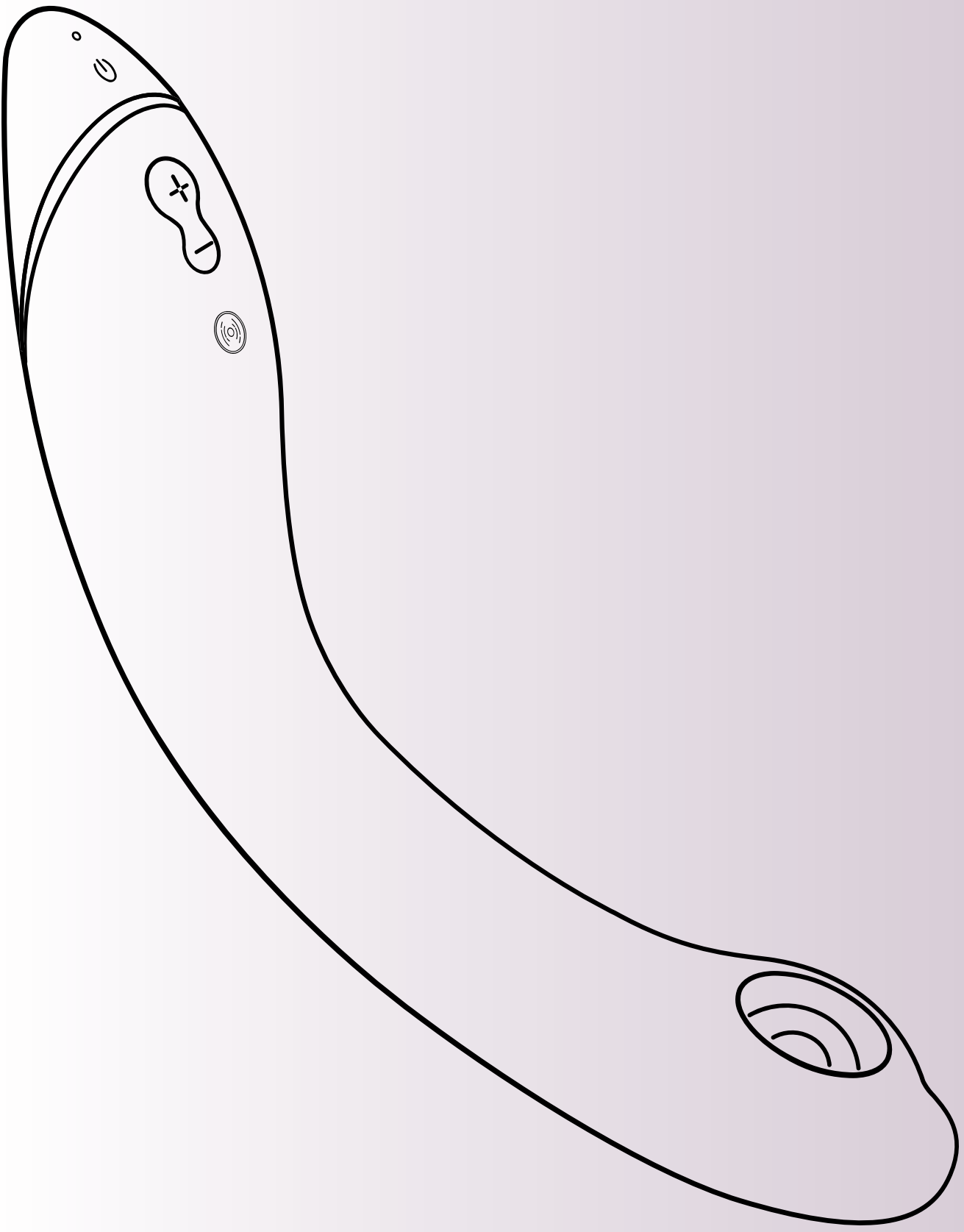

# BESCHRIJVING

**Led-scherm**  
Aan/Opladen

**Smart Silence**  
aan/uit  
2 seconden  
indrukken

**Vibratie**  
Druk kort op de  
knop om de  
intensiteit te  
activeren en  
te verhogen  
(3 niveaus)

**Pleasure Air Technology**  
(12 niveaus)

**Aan/uit**  
2 seconden indrukken

**Intensiteit verhogen**  
Druk kort op (+)

**Intensiteit verlagen**  
Druk kort op (-)

**Afterglow**  
Druk 1 seconde op (-)





# GEBRUIK

## 1. Aanzetten

2 seconden indrukken.  
Het led-lampje geeft aan dat  
het product is ingeschakeld.

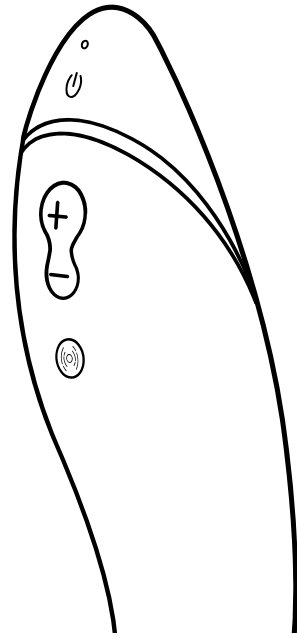

## 2. Gebruik

Gebruik **OG** eerst op je clitoris  
om in de stemming te komen.

Breng glijmiddel op waterbasis  
aan op de **OG**.

Nadat je bent opgewarmd, breng  
je **OG** in en verken je je G-Spot!

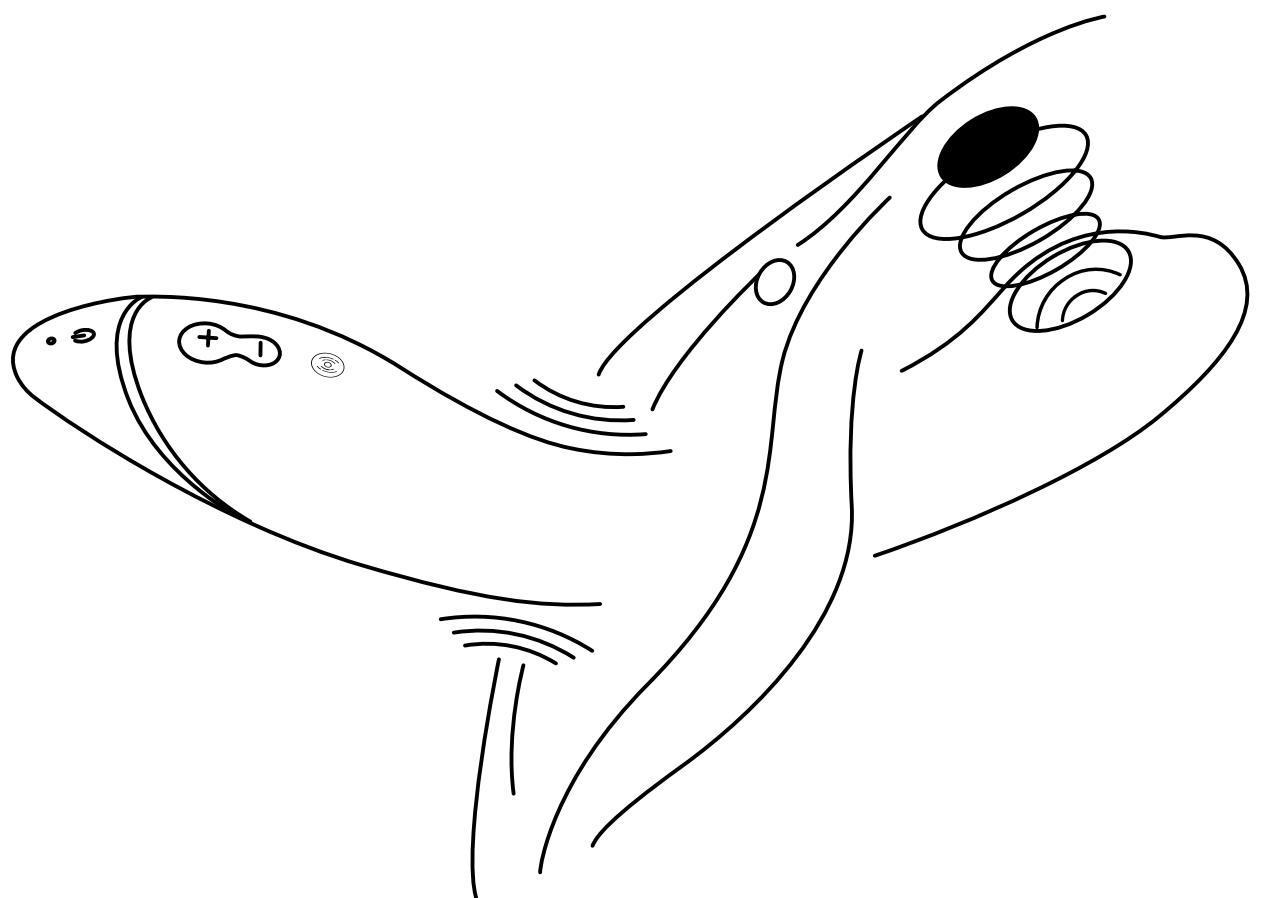
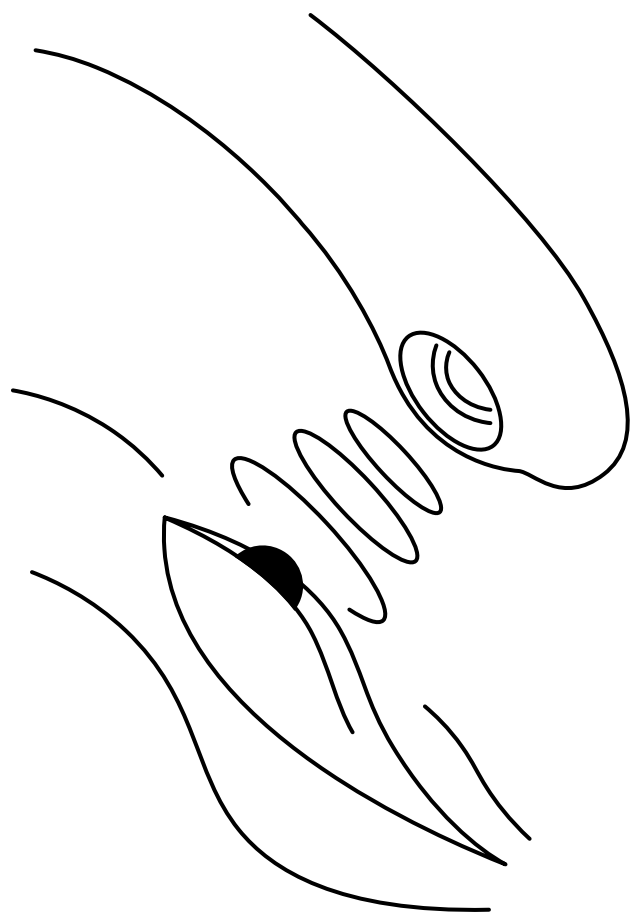

# GEBRUIK

## 3. Intensiteit wijzigen

### Verhogen

Kort indrukken

**12 intensiteitsniveaus**

### Verhogen

Kort indrukken

**3 vibratieniveaus**

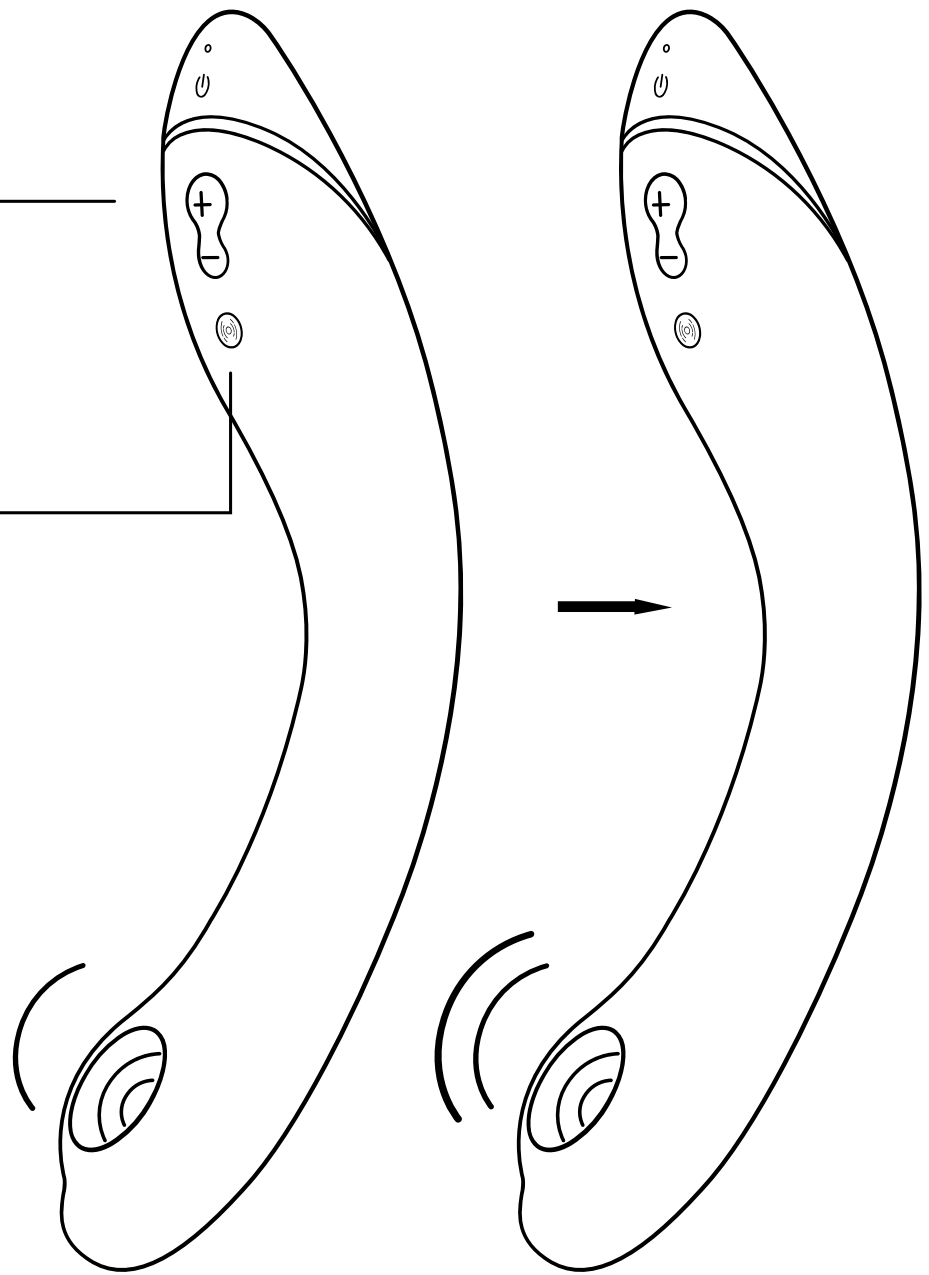

### Verlagen

Kort indrukken

### Afterglow

Druk 1 seconde op (-)  
om terug te gaan naar  
intensiteitsniveau 1

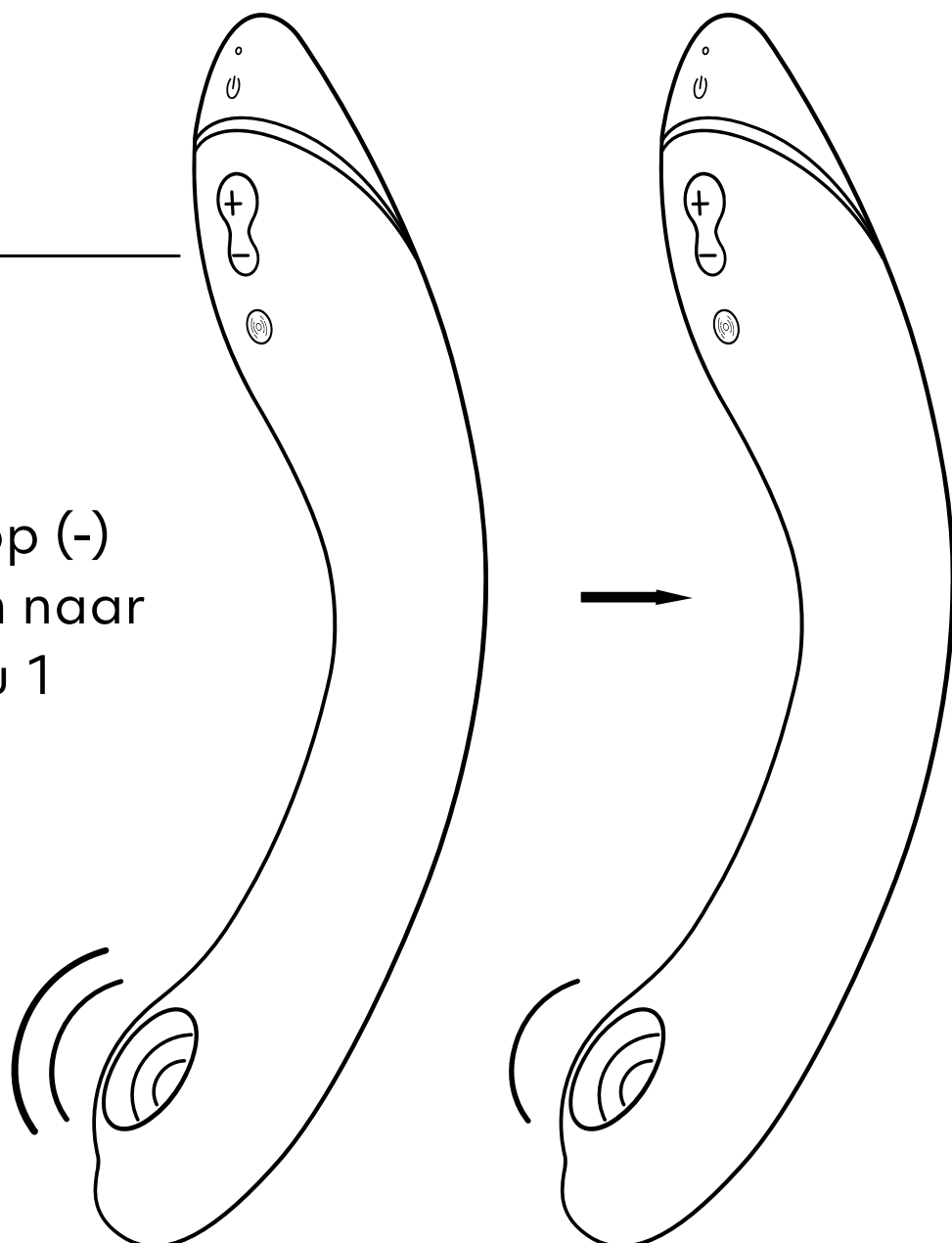

# GEBRUIK

4. **Uitzetten** •  
2 seconden indrukken

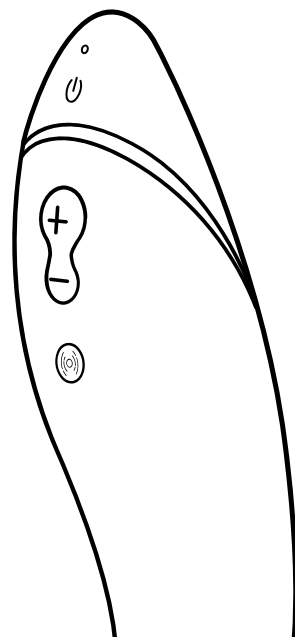

## SMART SILENCE

**OG** wordt alleen ingeschakeld als er bijna contact wordt gemaakt met de huid. Smart Silence wordt standaard uitgeschakeld. Houd de plus- en minknop 2 seconden ingedrukt om Smart Silence in of uit te schakelen.



**Smart Silence aan/uit**  
2 seconden indrukken

Smart Silence werkt mogelijk niet als de stimulatiekop nat is. Breng daarom geen glijmiddel aan op de Pleasure Air-kop.

# REINIGEN

Reinig onder water.

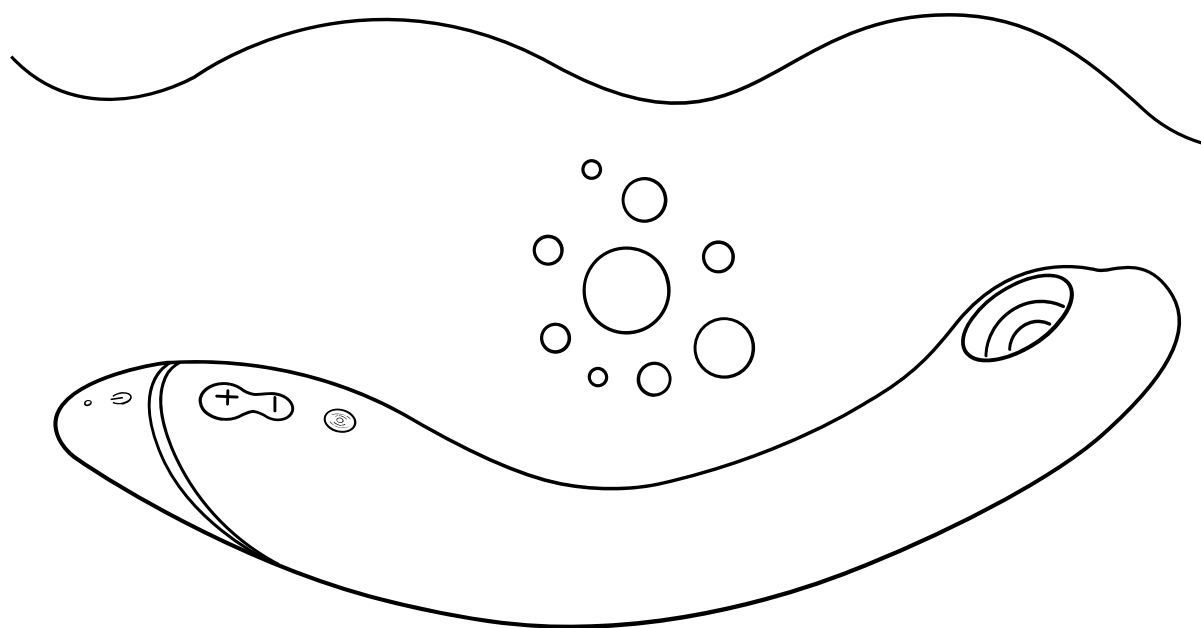

Gebruik de speeltjesreiniger.

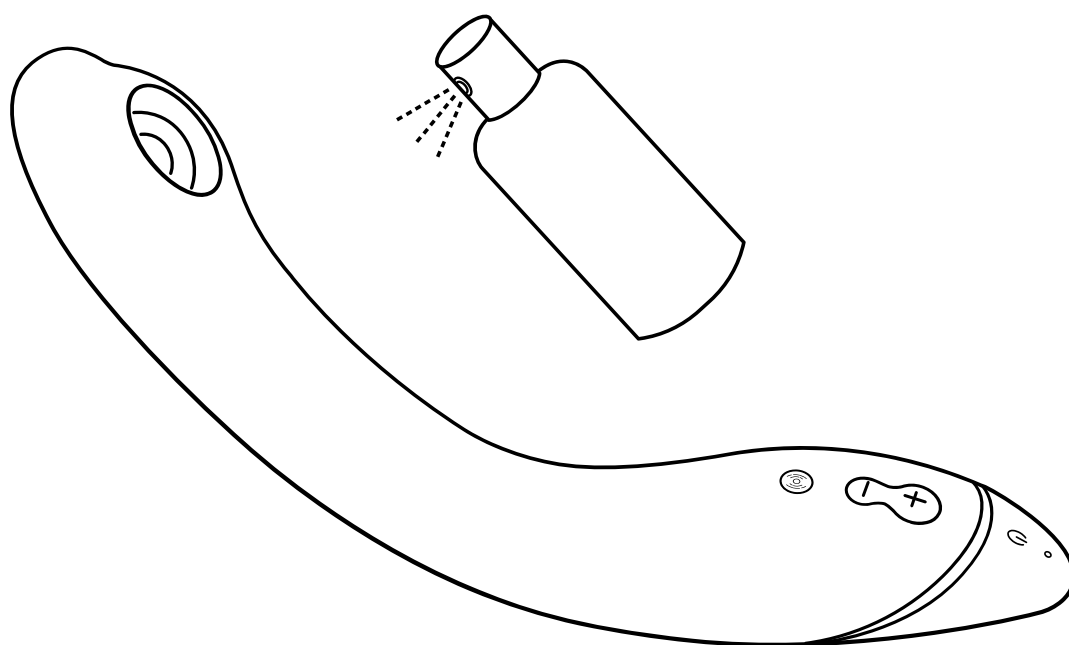

Droog voorzichtig af zonder te veel druk op het membraan uit te oefenen.

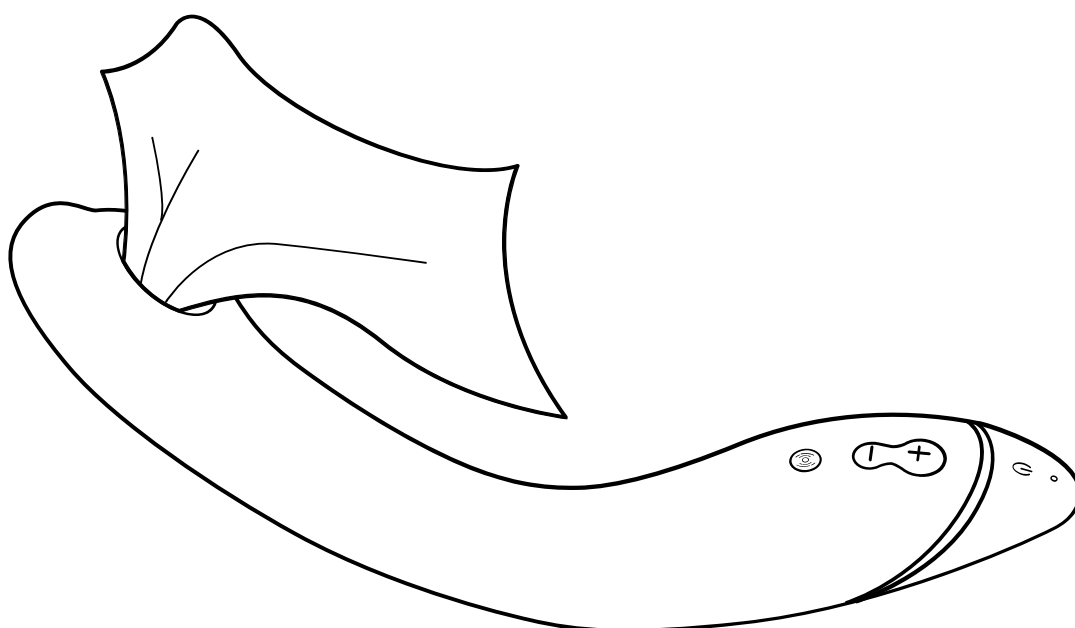

Waterdicht  
(IPX7)

# OPLADEN

Laad je **OG** op vóór het eerste gebruik. Vergeet ook niet je **OG** regelmatig op te laden, zodat de batterij lang meegaat.

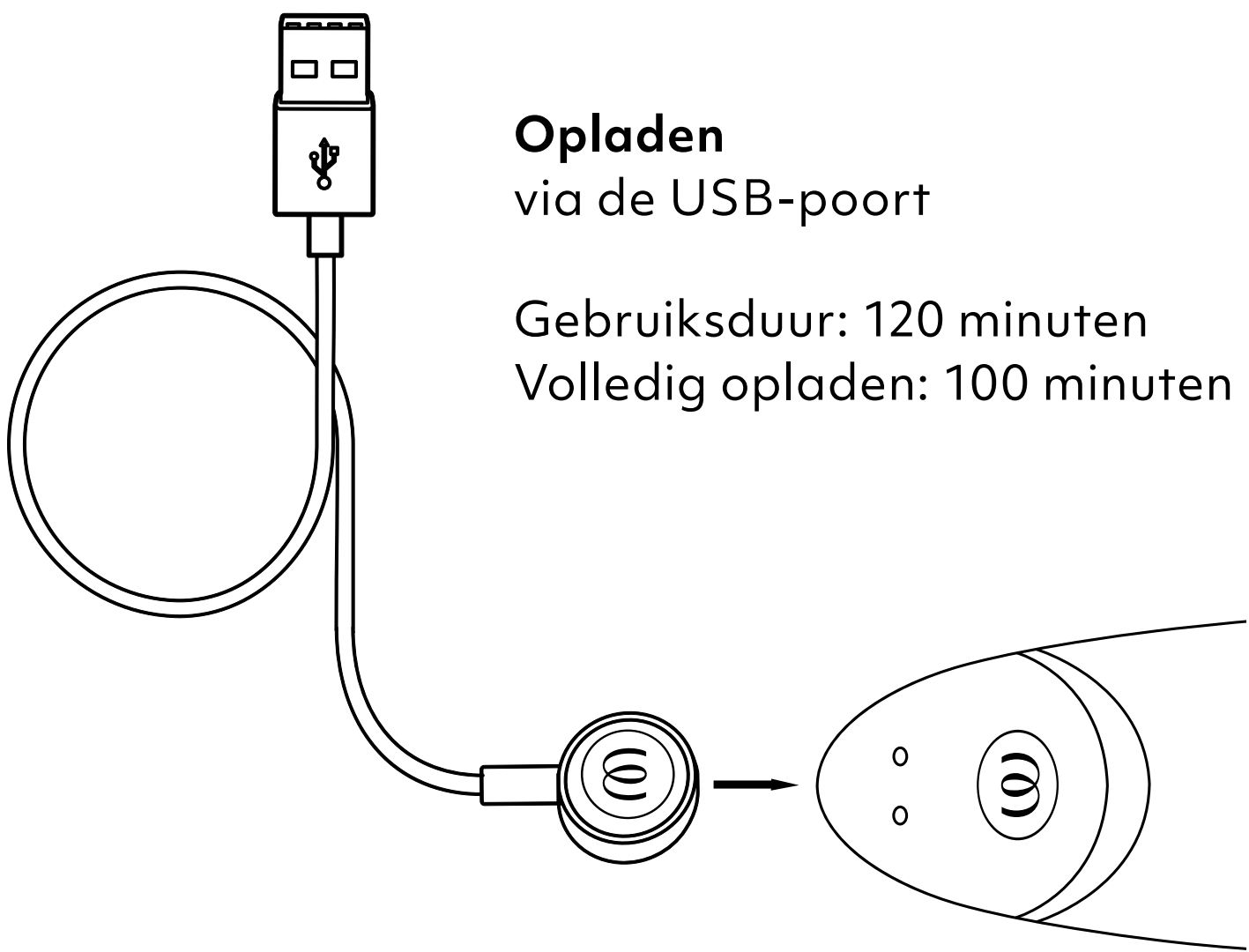

**Opladen**  
via de USB-poort

Gebruiksduur: 120 minuten  
Volledig opladen: 100 minuten

---

**LED**  
Aan/Uit/Opladen

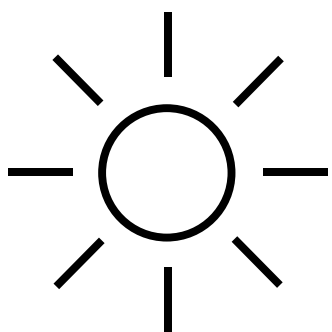

**Volledig opgeladen**  
Led-lampje ononderbroken  
verlicht

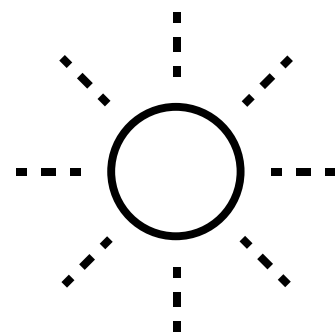

**Opladen**  
Led-lampje knippert

# SAFETY INSTRUCTIONS

## WAARSCHUWING

Alleen verkocht als nieuw product. Gebruik het product alleen waarvoor het bestemd is. Houd het product uit de buurt van kinderen. Niet geschikt voor medische doeleinden. Als je in behandeling bent bij een arts of een aandoening hebt waarvoor je een medisch hulpmiddel nodig heeft, raadpleeg dan je arts voordat je dit product gebruikt. Stop onmiddellijk met het gebruik van het product als je huidirritaties, pijn of ongemak ervaart en raadpleeg direct je arts.

Dit apparaat mag enkel door volwassenen worden gebruikt, en door mensen met een fysieke, sensorische of mentale beperking of gebrek aan ervaring en kennis, mits ze begeleiding of instructies krijgen met betrekking tot veilig gebruik van het apparaat en de mogelijke risico's ervan begrijpen. Dit apparaat is geen speelgoed voor kinderen.

Reiniging en onderhoud mogen niet worden uitgevoerd door kinderen. Gebruik het apparaat niet op gezwollen of ontstoken delen van de huid.

- Verwijder piercings en sieraden in het genitale gebied voor gebruik.
- Reinig het product altijd voor en na het gebruik volgens de instructies die in de handleiding vermeld staan.
- Om schade aan het product te voorkomen, mogen het product en de batterij niet worden blootgesteld aan temperaturen boven de 45°C, niet worden gedemonteerd of mechanisch dan wel elektrisch beschadigd worden.
- Het delen van seksspeeltjes kan geslachtsziekten overdragen. Deel je seksspeeltje met niemand anders dan met je partner. Gebruik zo nodig met je partner beschermende middelen. Gebruik het speeltje niet als je barstjes of andere beschadigingen in het buitenste materiaal ontdekt.
- Dit product is niet ontworpen voor anaal gebruik. Niet anaal gebruiken!
- Plaats de zachte kant van je product niet op een absorberend oppervlak om vlekken te voorkomen.
- Controleer het product en de oplader regelmatig op schade en gebruik het apparaat niet als blijkt dat onderdelen beschadigd zijn.
- Magnetische velden kunnen mechanische en elektronische componenten zoals pacemakers beïnvloeden. Gebruik het apparaat niet direct boven een pacemaker. Neem voor meer informatie contact op met je arts. Houd kaarten met een magnetische strip (zoals creditcards) uit de buurt van het apparaat, omdat deze beschadigd kunnen raken door de magneten van het product.
- Schakel het apparaat uit als het abnormaal lijkt te werken, en raadpleeg de FAQ's op onze website.

## OPLADEN

- Controleer voordat je het apparaat voor de eerste keer gaat gebruiken de lokale netspanning. Deze mag niet hoger zijn dan de maximale netspanning die staat aangegeven op de oplader.
- De voeding voor het apparaat moet extra lage veiligheidsspanning zijn die overeenkomt met de gegevens op het apparaat.
- Gebruik of reinig het product niet terwijl de batterij wordt opgeladen.
- Het apparaat of de laadkabel tijdens het opladen nooit onderdompelen in water of andere vloeistoffen.
- Het apparaat bevat een accu die niet vervangen kan worden.
- Dit product bevat een oplaadbare lithium-ion accu.
- Koppel de laadkabel na elk laadproces los van het circuit.

## AANWIJZINGEN VOOR OPTIMAAL GEBRUIK VAN HET PRODUCT:

- Laad het apparaat regelmatig op, ook als het niet wordt gebruikt: zo is een lange levensduur van de batterij gegarandeerd.
- Bewaar het apparaat op een veilige, droge plaats en vermijd direct zonlicht.
- We raden aan om een glijmiddel op waterbasis te gebruiken. Gebruik geen geparfumeerde glijmiddelen, gels of massageoliën op basis van siliconen of alcohol, om schade aan het speeltje te voorkomen.

# GENERAL INFORMATION

## ELECTRICAL RATING

**Model:** OG

**Model No.:** TES10A

**Power Input:**

3,7 V=0,62 A: Built-in Li-Polymer rechargeable battery.

5 V=0,5 A: When charged using USB.

Use USB AC adaptor (not included) with power output corresponding to product rating. Use original provided cable only."

## CONTENT OF DELIVERY

Womanizer OG G-Spot vibrator, USB charging cable (AC adapter not included), cotton storage pouch, quick start guide, safety instructions

## ENVIRONMENTAL PROTECTION

As a distributor of electronic devices, we are legally obliged to accept the return of waste electrical and electronic devices free of charge. We expressly state that you as the user are legally obliged to return used batteries.

Never throw away electronic devices or batteries in the household waste. The symbol shown below (crossed-out wheeled bin) is intended to expressly remind you of this.

## MANUFACTURED AND DISTRIBUTED BY

**WOW Tech Europe GmbH**

Hermann-Blankenstein-Strasse 5

10249 Berlin

[www.wowtech.com](http://www.wowtech.com)

WOW Tech Europe GmbH reserves the right to make technical changes and changes to the design that serve to improve the device.

For information regarding patents see [womanizer.com/patents](http://womanizer.com/patents).

## CUSTOMER CARE

[care@womanizer.com](mailto:care@womanizer.com)

[womanizer.com](http://womanizer.com)

Designed in Germany. Made in China.

Date of issue: 10/2022.



# ZIN IN MEER?

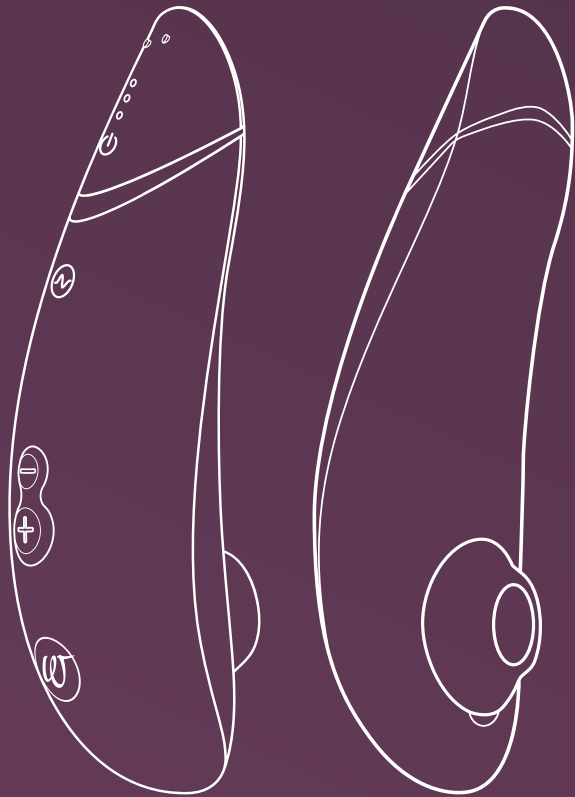

Pleasure Air  
Technology

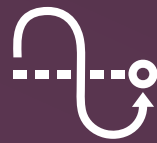

Autopilot



Smart Silence

**Premium 2**  
Define your luxury

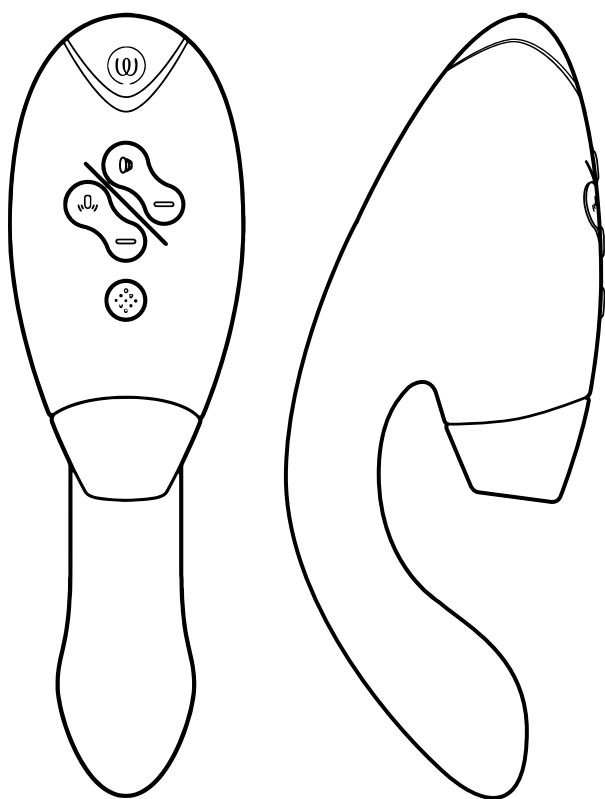

Pleasure Air  
Technology



Double Stimulation



Smart Silence

**DUO 2**  
Indulge in whole-body orgasms





#IMASTURBATE

# Hi!

Děkujeme, že jste si vybrali **WOMANIZER OG**.

Vítejte ve světě plném smyslných zážitků, které obohatí váš život. Tím, že jste se rozhodla pro **WOMANIZER**, získáte nejen záruku nesrovnatelných orgasmů, ale také zcela novou touhu po rozkoši.

Užijte si svůj **WOMANIZER OG** – jeden orgasmus za druhým.

Mějte se ráda!



POPIS

ZPŮSOB POUŽITÍ

SMART SILENCE

ČIŠTĚNÍ

NABÍJENÍ

SAFETY INSTRUCTIONS

VŠEOBECNÉ INFORMACE

Please read the safety instructions in the  
Compliance & Safety Information before first use.

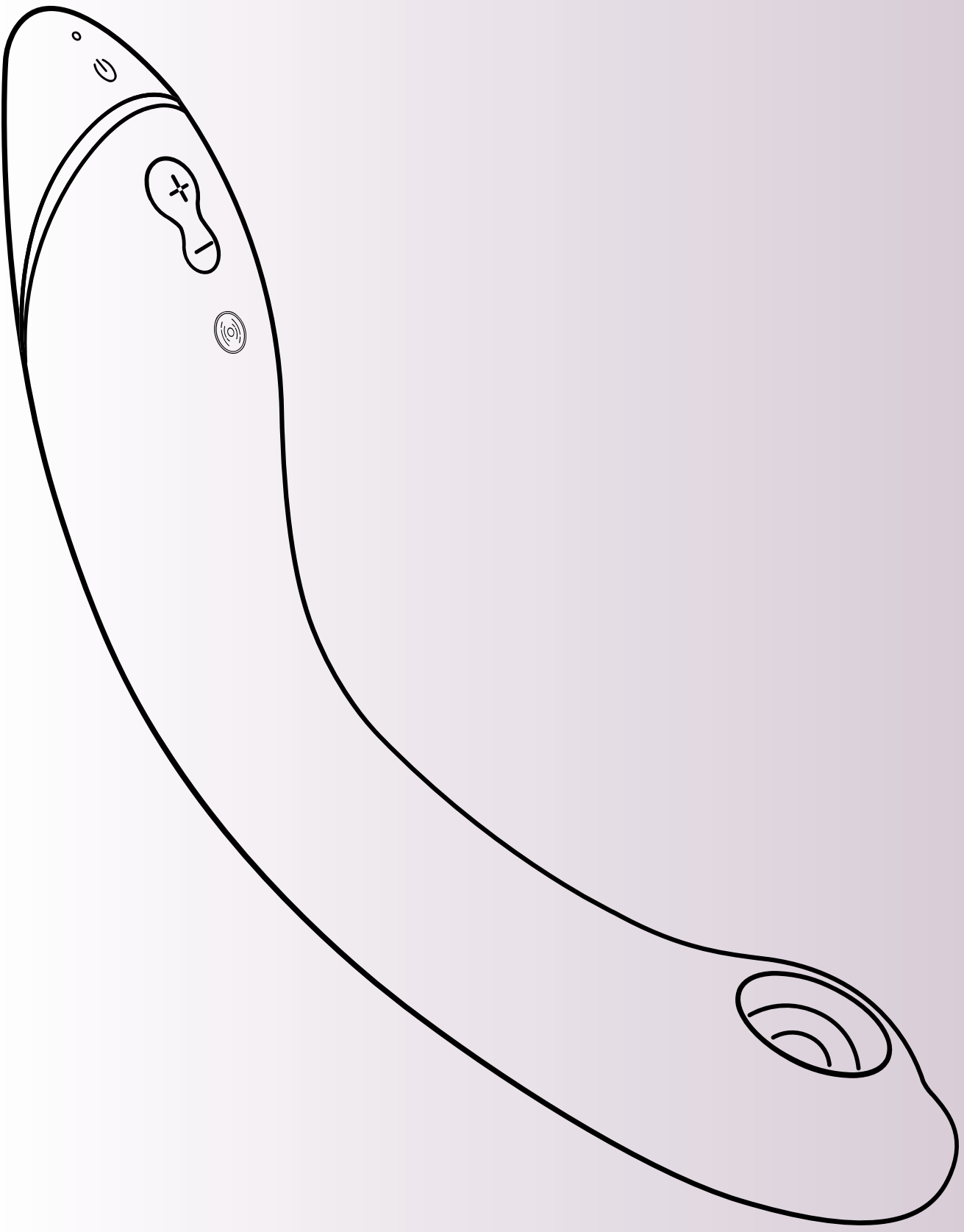

# POPIS

**LED displej**  
Zapnutí/nabíjení

**Zapnutí/vypnutí  
funkce Smart Silence**  
Stiskněte na  
2 sekundy

**Vibrace**  
Krátkým stisknutím  
aktivujte a  
zvyšte intenzitu  
(3 úrovně)

**Pleasure Air Technology**  
(12 úrovně)

**Zap./vyp.**  
Stiskněte na  
2 sekundy

**Zvýšení intenzity**  
Krátce stiskněte (+)

**Snížení intenzity**  
Krátce stiskněte (-)

**Příjemné dozvuky**  
Stiskněte (-) na 1 sekundu



# ZPŮSOB POUŽITÍ

## 1. Zapnutí

Stiskněte na 2 sekundy.  
LED indikuje zapnutí  
produktu.

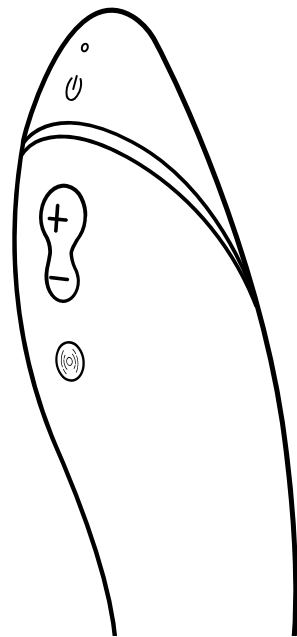

## 2. Použití

Pokud se chcete dostat do  
nálady, použijte **OG** nejdřív  
na klitoris.

Naneste lubrikant na vodní  
bázi na tělo **OG**.

Až se dostanete do nálady,  
zaveďte **OG** a prozkoumejte  
svůj bod G!

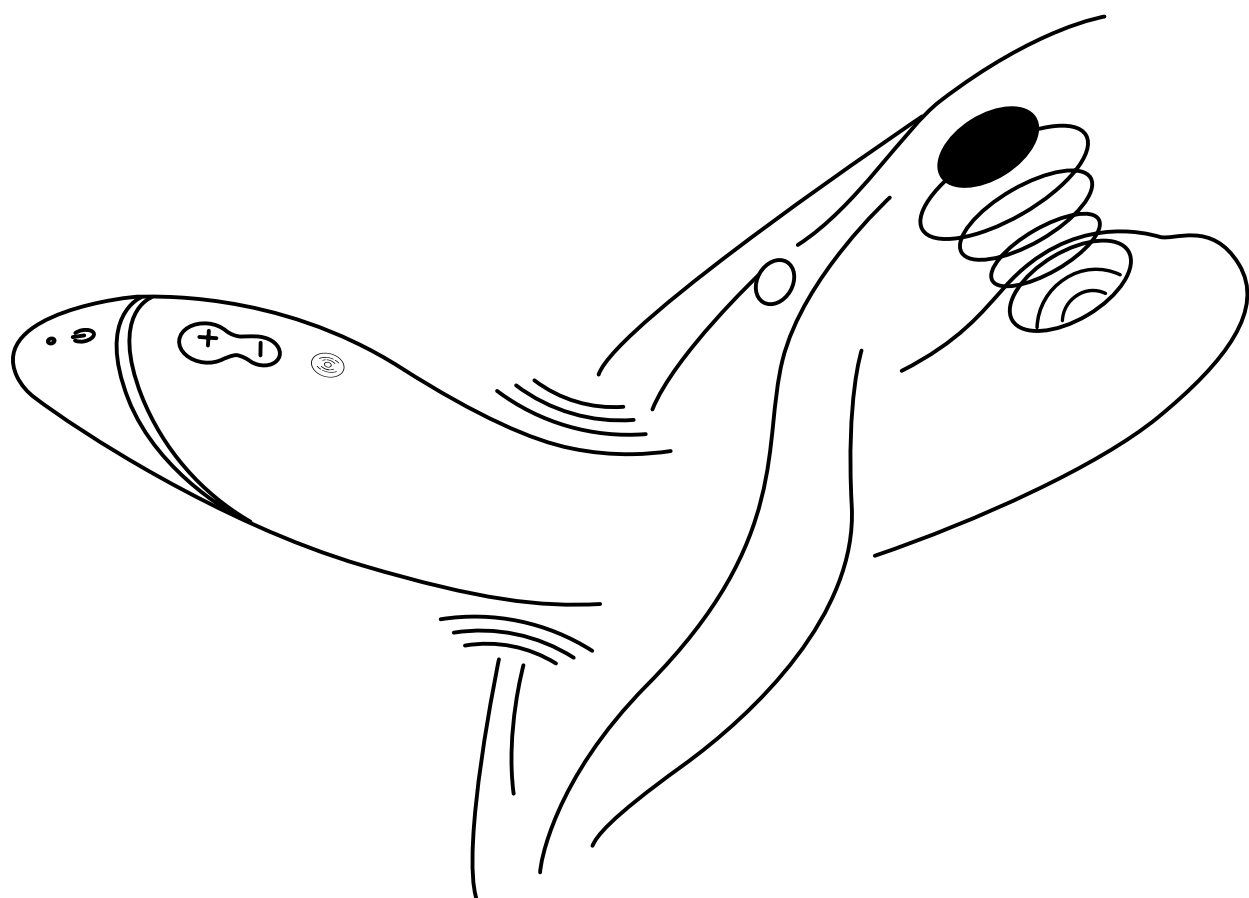
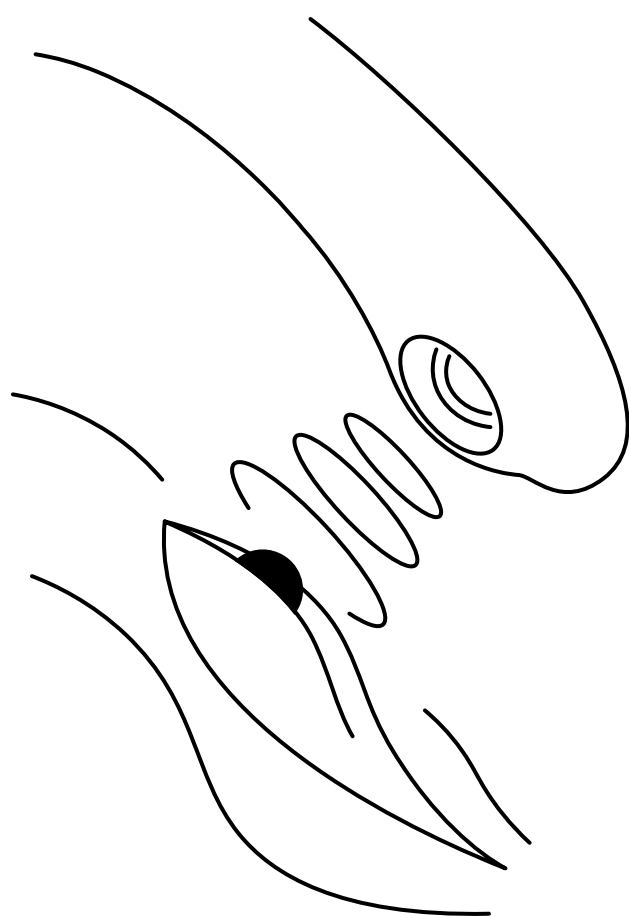

# ZPŮSOB POUŽITÍ

## 3. Změnit intenzitu

**Zvýšit**

Krátce stiskněte  
**12 úrovní intenzity**

**Zvýšit**

Krátce stiskněte  
**3 úrovně vibrací**

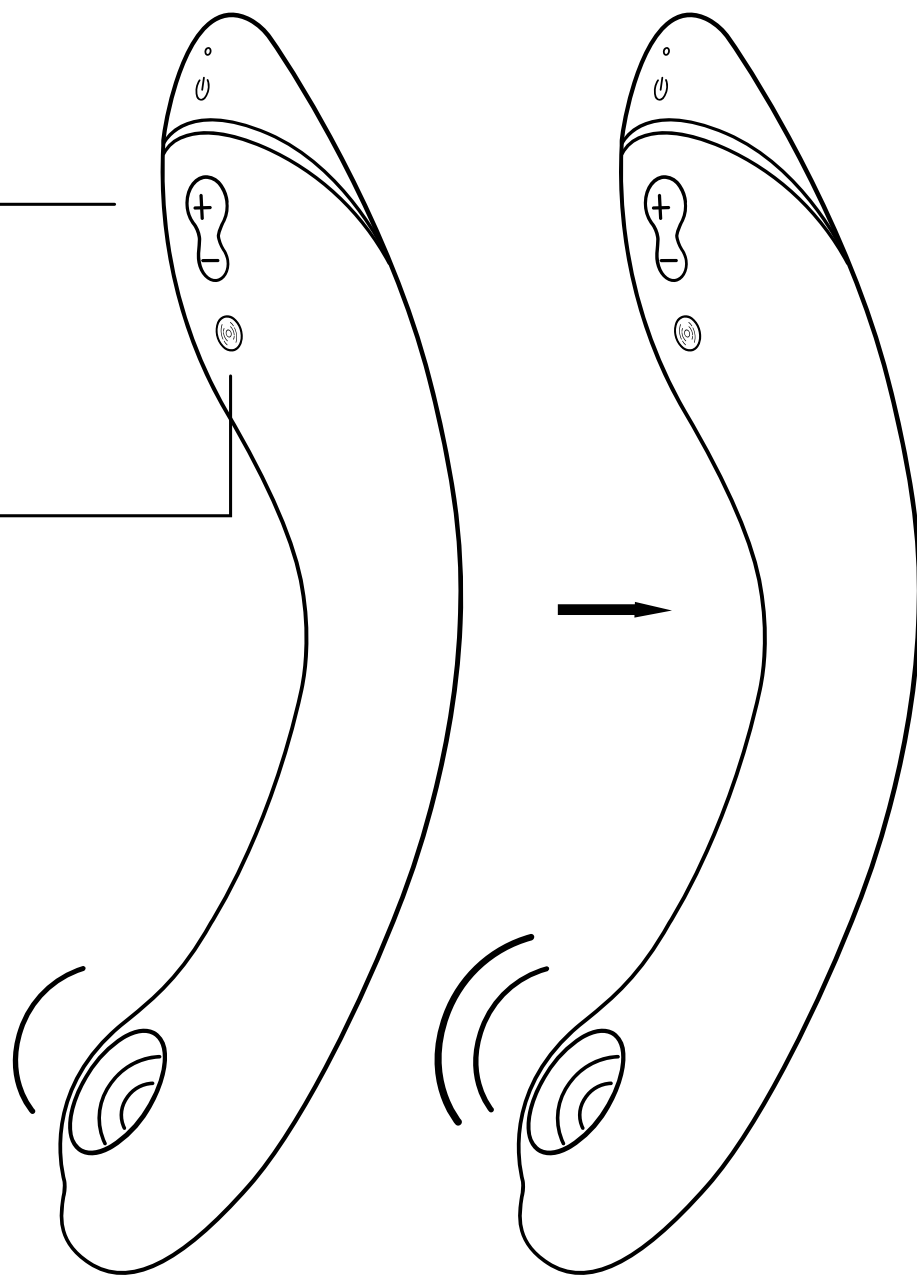

**Snížit**

Krátce stiskněte

**Příjemné dozvuky**

Stisknutím tlačítka (-)  
na 1 sekundu se vrátíte  
na úroveň intenzity 1

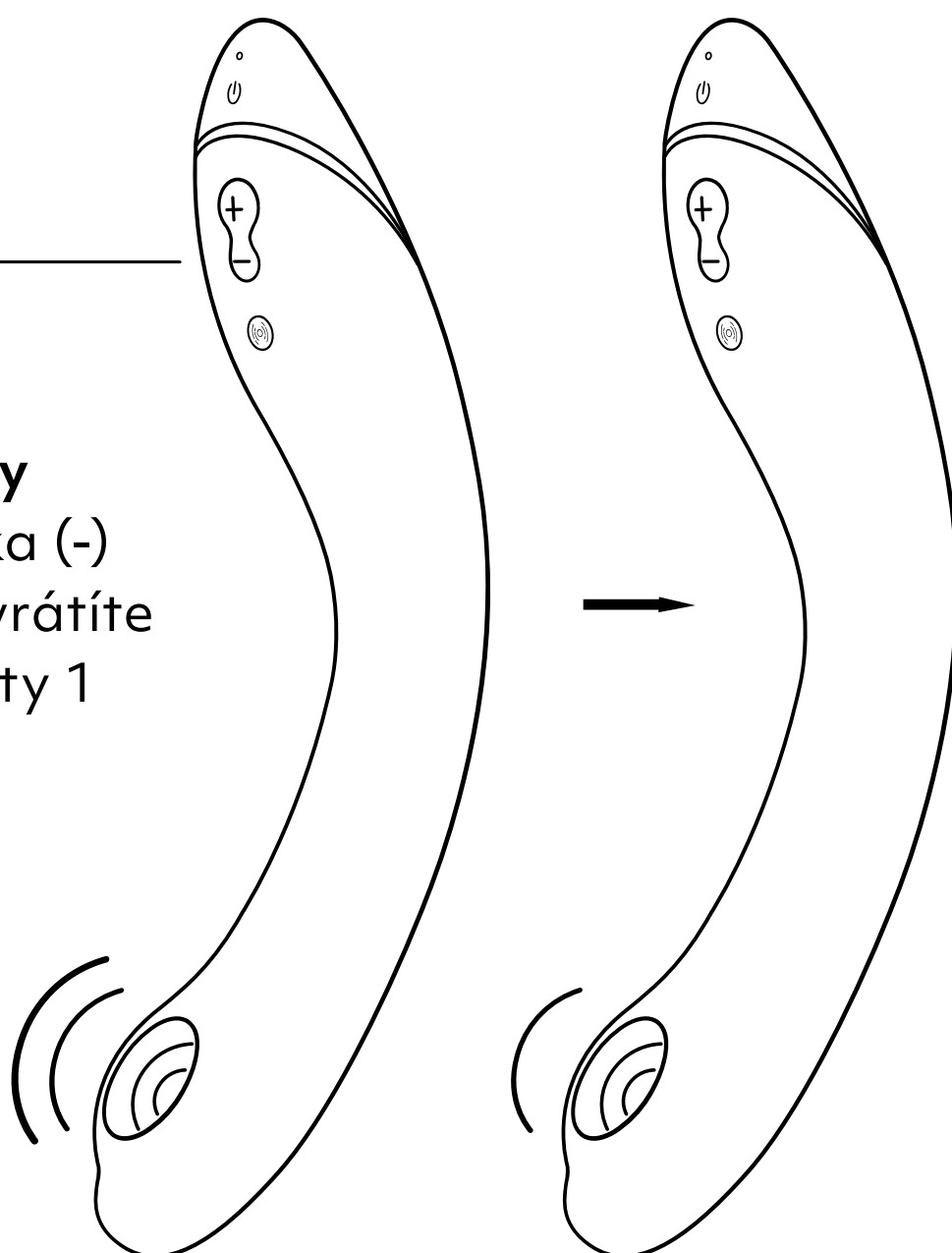

# ZPŮSOB POUŽITÍ

4. **Vypnutí** —————  
Stiskněte na 2 sekundy.

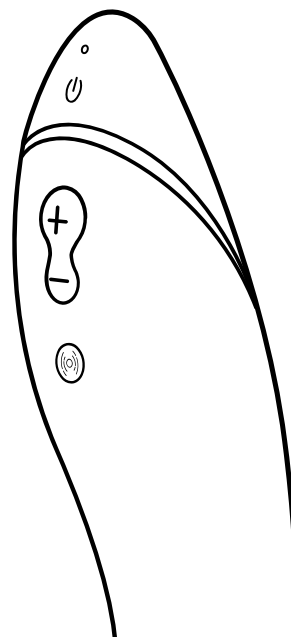

## SMART SILENCE

**OG** se zapne jen tehdy, pokud se téměř dotýká vaší pokožky. Funkce Smart Silence bude předem zapnutá. Stisknutím a podržením tlačítek plus a mínus na 2 vteřiny zapnete nebo vypnete funkci Smart Silence.



**Smart Silence Zap./vyp.**  
Stiskněte na 2 sekundy.

Funkce Smart Silence nemusí fungovat, pokud je stimulační hlavice mokrá. Dbejte na to, abyste do hlavice Pleasure Air nenanesli lubrikant.



# ČIŠTĚNÍ

Omyjte ji pod vodou.

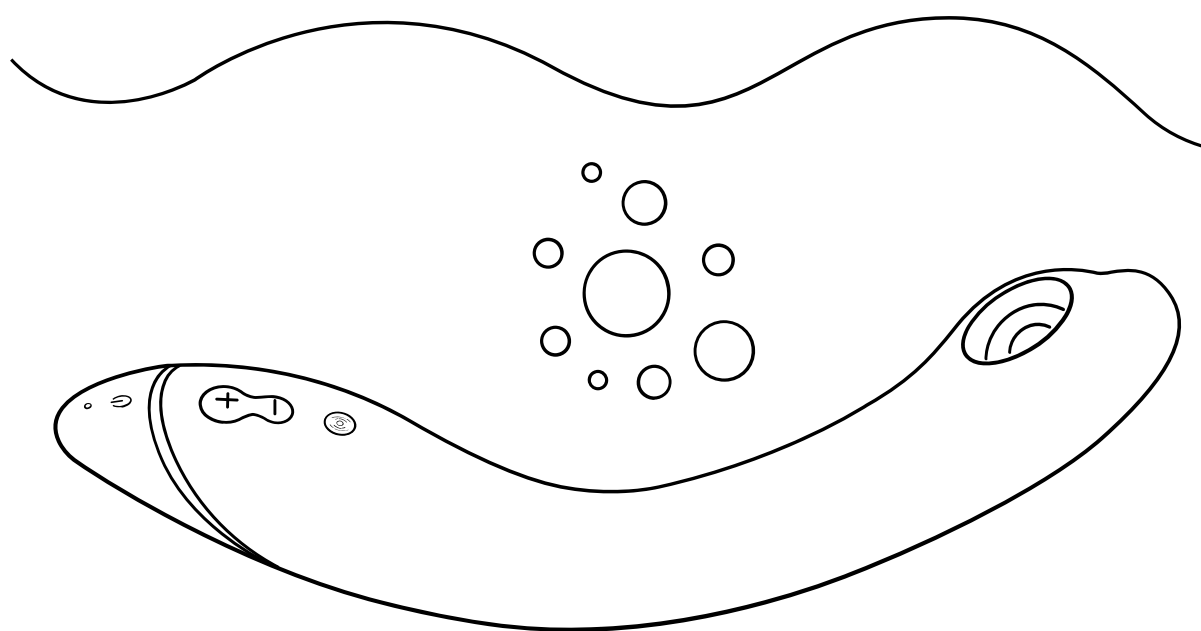

Nastříkejte čisticí prostředek na hračky.

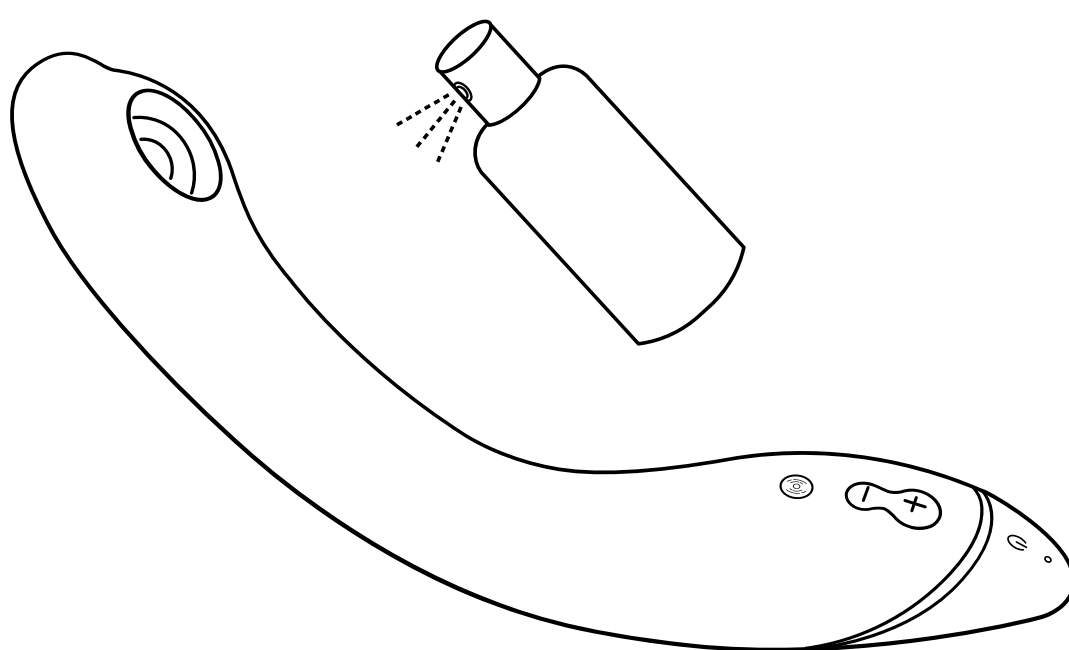

Opatrně osušte, aniž byste na membránu  
vyvíjeli příliš velký tlak.

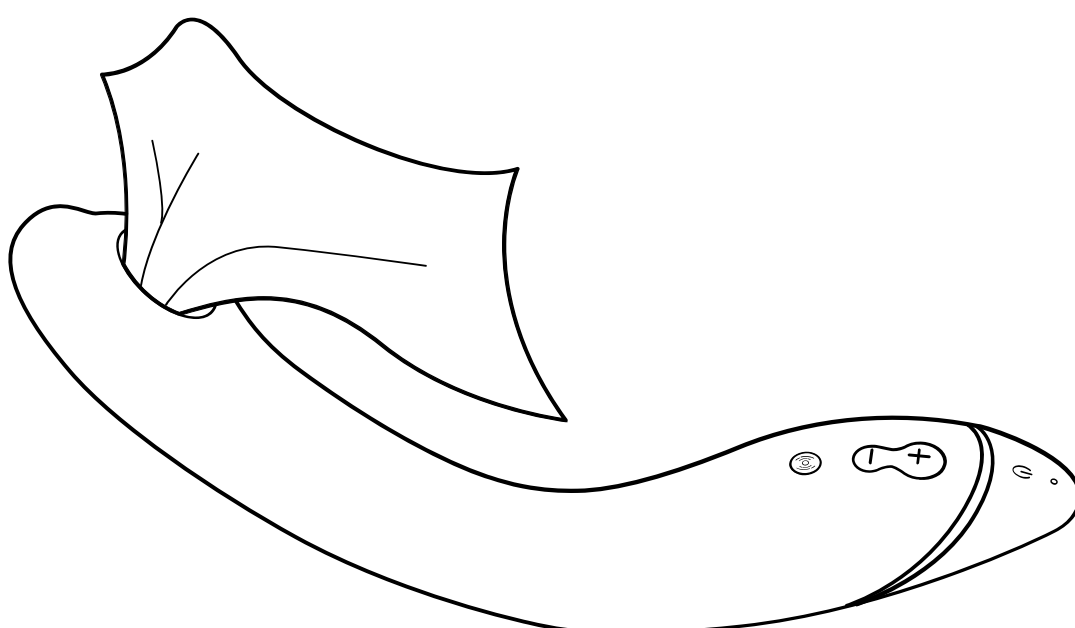

Vodotěsný  
(IPX7)

# NABÍJENÍ

Před prvním použitím **OG** nabijte. Nezapomínejte **OG** nabíjet pravidelně v zájmu zachování dlouhé životnosti baterie.

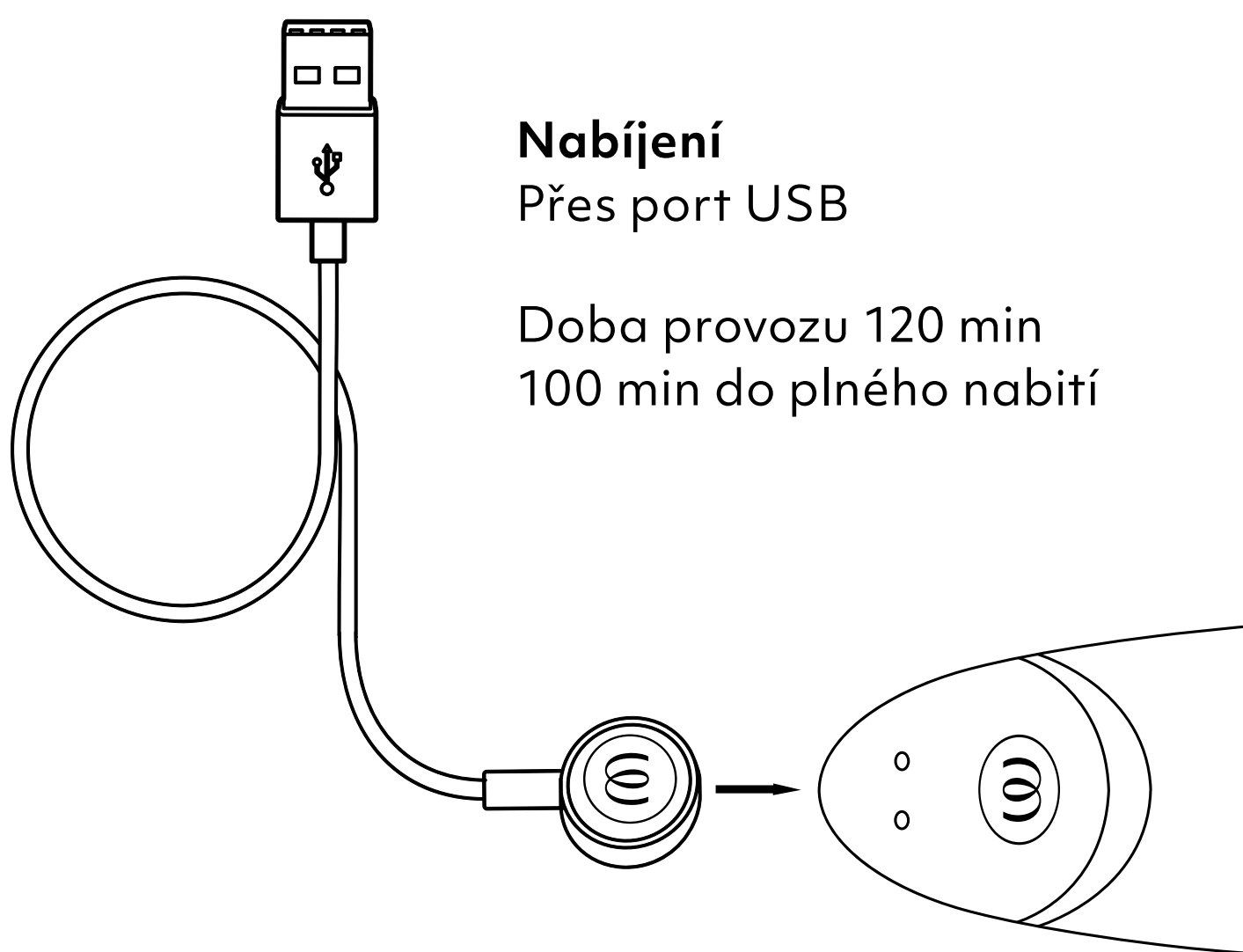

## Nabíjení

Přes port USB

Doba provozu 120 min  
100 min do plného nabití

---

## LED

Zap./vyp./nabíjení

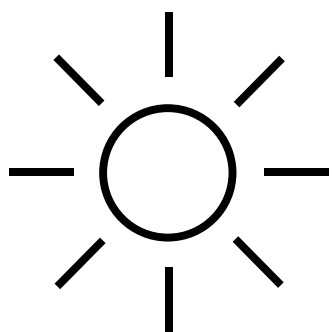

### Plně nabitó

LED svítí nepřetržitě

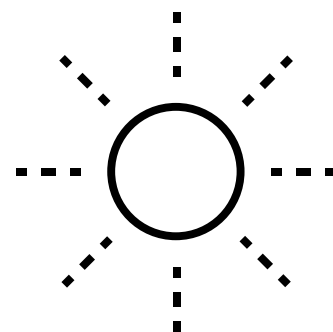

### Nabíjení

LED bliká

# SAFETY INSTRUCTIONS

## UPOZORNĚNÍ

Výrobek lze prodávat pouze jako nový. Produkt používejte pouze k určenému účelu. Není vhodný pro lékařské účely. Výrobek uchovávejte mimo dosah dětí. Pokud jste v péči lékaře a/nebo váš stav vyžaduje používání zdravotnického prostředku, poraďte se před použitím tohoto výrobku se svým lékařem. Pokud by došlo k podráždění pokožky, objeví-li se bolest nebo nepříjemný pocit, ihned přestaňte výrobek používat a poraďte se se svým lékařem.

Toto zařízení mohou používat pouze dospělí. Osoby se sníženými fyzickými, smyslovými nebo duševními schopnostmi nebo nedostatkem zkušeností a znalostí mohou zařízení používat pouze pod dohledem, nebo po obdržení pokynů k bezpečnému používání zařízení, a pokud pochopily související rizika. Se zařízením by si neměly hrát děti. Čištění a údržbu by neměly provádět děti. Nepoužívejte na oteklé nebo zanícené oblasti pokožky.

- Před použitím odstraňte piercing a šperky v oblasti genitálií.
- Před každým použitím a po něm výrobek vyčistěte podle pokynů uvedených v návodu.
- Aby se předešlo poškození výrobku, nesmí být výrobek, ani jeho baterie vystavovány teplotám nad 45°C, nesmí být demontovány, ani mechanicky, či elektricky poškozeny.
- Při sdílení sexuálních hraček může dojít k přenosu pohlavně přenosných chorob. Sexuální hračky sdílejte pouze se svým partnerem. V případě potřeby použijte se svým partnerem ochranné prostředky. Hračku nepoužívejte, pokud si na povrchu všimnete prasklin nebo poškození.
- Produkt není určený k análnímu použití. Nepoužívejte análně!
- Nepokládejte měkkou stranu výrobku na nasákový povrch, abyste předešli vzniku skvrn.
- Pravidelně kontrolujte, zda není poškozená nabíječka, ani hračka, a pokud jsou některé součástky poškozeny, zařízení nepoužívejte.
- Mechanické a elektronické součásti může ovlivnit magnetické pole, například kardiostimulátory. Nepoužívejte zařízení přímo přes kardiostimulátor. Pro více informací kontaktujte svého lékaře. Předcházejte tomu, aby se do blízkosti zařízení dostaly karty s magnetickými pruhy (např. kreditní karty), protože magnety ve výrobku by mohly tyto karty poškodit.
- Jestliže se zdá, že hračka nefunguje správně, vypněte ji a vyhledejte oddíl zákaznické podpory na našich webových stránkách.

## NABÍJENÍ

Před prvním použitím nabíječky zkontrolujte úroveň napětí v místní síti, protože elektrické napětí nesmí překročit maximální síťové napětí uvedené na nabíječce.

- Zařízení musí být napájeno pouze bezpečným velmi nízkým napětím, odpovídajícím označení na zařízení.
- Během nabíjení baterie produkt nepoužívejte ani nečistěte.
- Nabíječku ani nabíjecí kabel nikdy neponořujte do vody ani jiných kapalin.
- Toto zařízení obsahuje baterie, které není možné vyměnit.
- Tento produkt obsahuje dobíjecí lithium-iontovou baterii.
- Po každém procesu nabíjení odpojte nabíjecí kabel od obvodu.

## PRO OPTIMÁLNÍ VYUŽITÍ VÝROBKU DODRŽUJTE NÁSLEDUJÍCÍ POKYNY:

- Přístroj pravidelně nabíjejte, i když ho právě nepoužíváte, abyste dosáhli dlouhé životnosti baterie.
- Skladujte na bezpečném a suchém místě, bez vystavení přímému slunečnímu záření.
- Spolu s hračkou doporučujeme používat lubrikant na bázi vody. Abyste předešli poškození výrobku, nepoužívejte parfemované lubrikanty, gely na bázi silikonu, masážní oleje, ani přípravky obsahující alkohol.

# GENERAL INFORMATION

## ELECTRICAL RATING

**Model:** OG

**Model No.:** TES10A

**Power Input:**

3,7 V=0,62 A: Built-in Li-Polymer rechargeable battery.

5 V=0,5 A: When charged using USB.

Use USB AC adaptor (not included) with power output corresponding to product rating. Use original provided cable only."

## CONTENT OF DELIVERY

Womanizer OG G-Spot vibrator, USB charging cable (AC adapter not included), cotton storage pouch, quick start guide, safety instructions

## ENVIRONMENTAL PROTECTION

As a distributor of electronic devices, we are legally obliged to accept the return of waste electrical and electronic devices free of charge. We expressly state that you as the user are legally obliged to return used batteries.

Never throw away electronic devices or batteries in the household waste. The symbol shown below (crossed-out wheeled bin) is intended to expressly remind you of this.

## MANUFACTURED AND DISTRIBUTED BY

**WOW Tech Europe GmbH**

Hermann-Blankenstein-Strasse 5

10249 Berlin

[www.wowtech.com](http://www.wowtech.com)

WOW Tech Europe GmbH reserves the right to make technical changes and changes to the design that serve to improve the device.

For information regarding patents see [womanizer.com/patents](http://womanizer.com/patents).

## CUSTOMER CARE

[care@womanizer.com](mailto:care@womanizer.com)

[womanizer.com](http://womanizer.com)

Designed in Germany. Made in China.

Date of issue: 10/2022.



# PŘEJETE SI JEŠTĚ NĚCO VÍC?

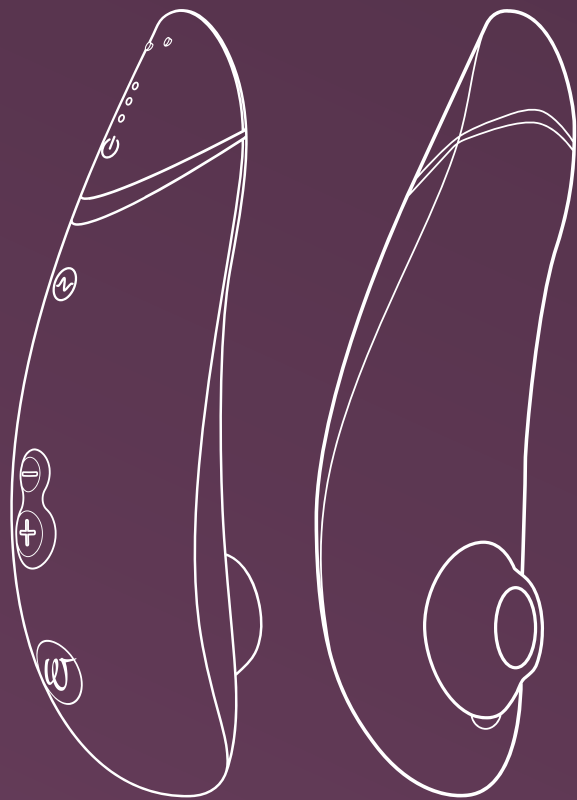

Pleasure Air  
Technology

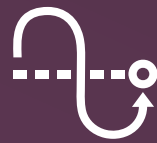

Autopilot



Smart Silence

**Premium 2**  
Define your luxury

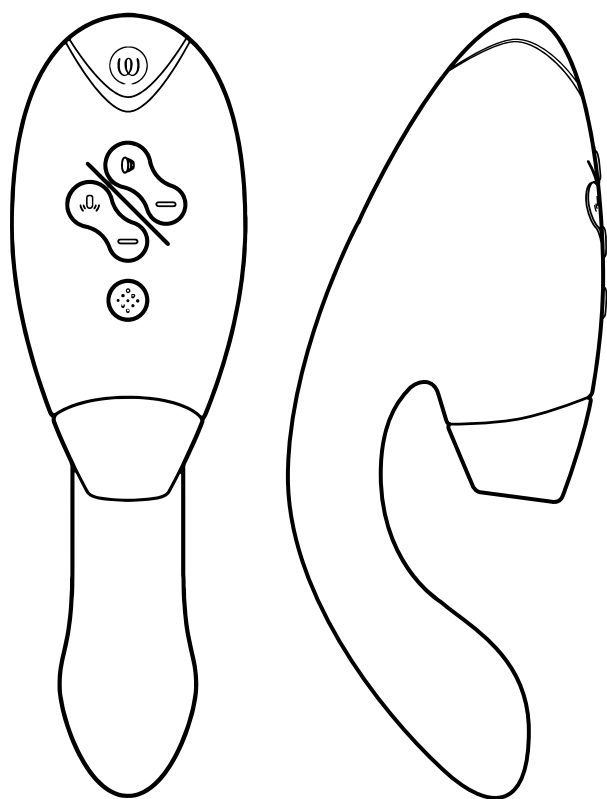

Pleasure Air  
Technology



Double Stimulation



Smart Silence

**DUO 2**  
Indulge in whole-body orgasms



#IMASTURBATE

# Hi!

Спасибо, что выбрали **WOMANIZER**

Добро пожаловать в мир чувственных наслаждений, благодаря которым ваша жизнь наполнится яркими красками. Выбирая **WOMANIZER**, вы получаете не только гарантированные и ни с чем не сравнимые оргазмы, но и возможность достигать небывалого возбуждения.

Добро пожаловать в мир чувственных наслаждений, благодаря которым ваша жизнь наполнится яркими красками. Выбирая **WOMANIZER**, вы получаете не только гарантированные и ни с чем не сравнимые оргазмы, но и возможность достигать небывалого возбуждения.

Побалуйте себя!



**ОПИСАНИЕ**

**КАК ПОЛЬЗОВАТЬСЯ**

**SMART SILENCE**

**ЧИСТКА**

**ЗАРЯДКА**

**НЕСКОЛЬКО ХИТРОСТЕЙ,  
ЧТОБЫ ПОЛУЧИТЬ  
УДОВОЛЬСТВИЕ С ПОМОЩЬЮ  
WOMANIZER OG**

**SAFETY INSTRUCTIONS**

**ОБЩИЕ СВЕДЕНИЯ**

Please read the safety instructions in the  
Compliance & Safety Information before first use.



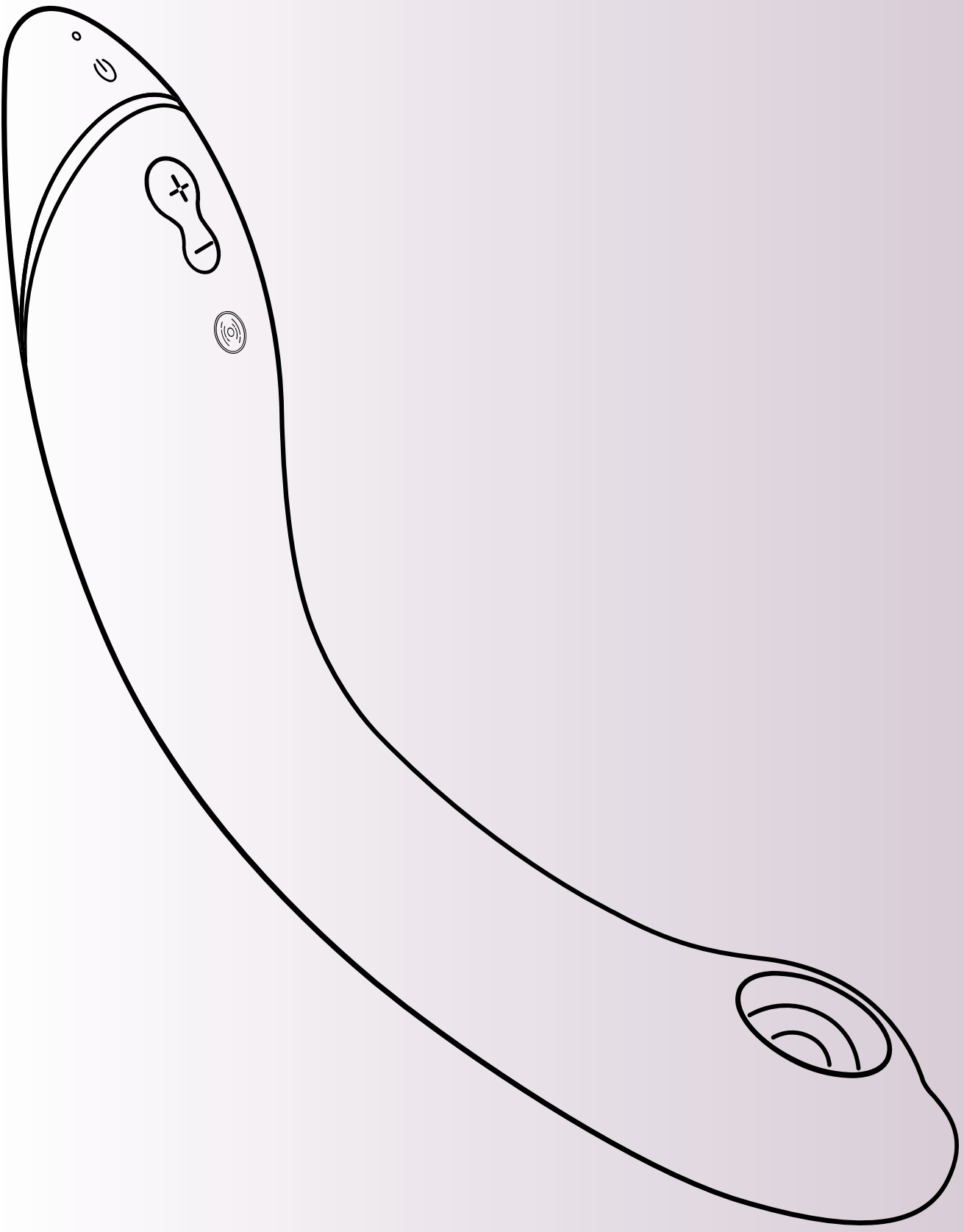

# ОПИСАНИЕ

**Светодиодный**  
Включение/зарядка

**Включение/  
выключение  
Smart Silence**  
Нажмите и  
удерживайте в  
течение 2 секунд

**Вибрация**  
Нажмите и  
отпустите для  
включения и  
увеличения  
интенсивности

**Технология  
Pleasure Air Technology**  
(12 уровней)

**Включение/  
выключение**  
Нажмите и удерживайте  
в течение 2 секунд

**Увеличение  
интенсивности**  
Нажмите (+) и  
отпустите 2 секунд

**Уменьшение  
интенсивности**  
Нажмите (-) и отпустите

**Afterglow**  
Нажмите (-) и  
удерживайте в  
течение 1 секунды



# КАК ПОЛЬЗОВАТЬСЯ

## 1. Включение

Нажмите и удерживайте в течение 2 секунд  
Свечение светодиода означает, что изделие включено.

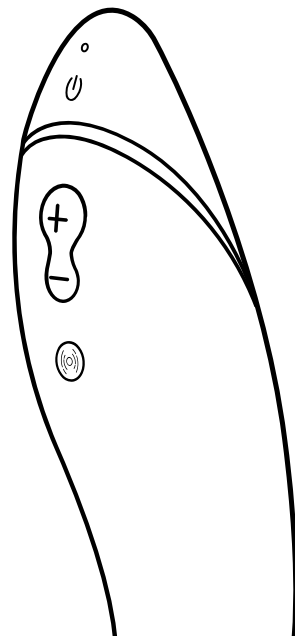

## 2. Использование

Чтобы проникнуться нужным настроением, сначала используйте **OG** для стимуляции клитора.

Нанесите смазку на водной основе на корпус **OG**.

Когда достигнете возбуждения, введите **OG** и исследуйте точку G!

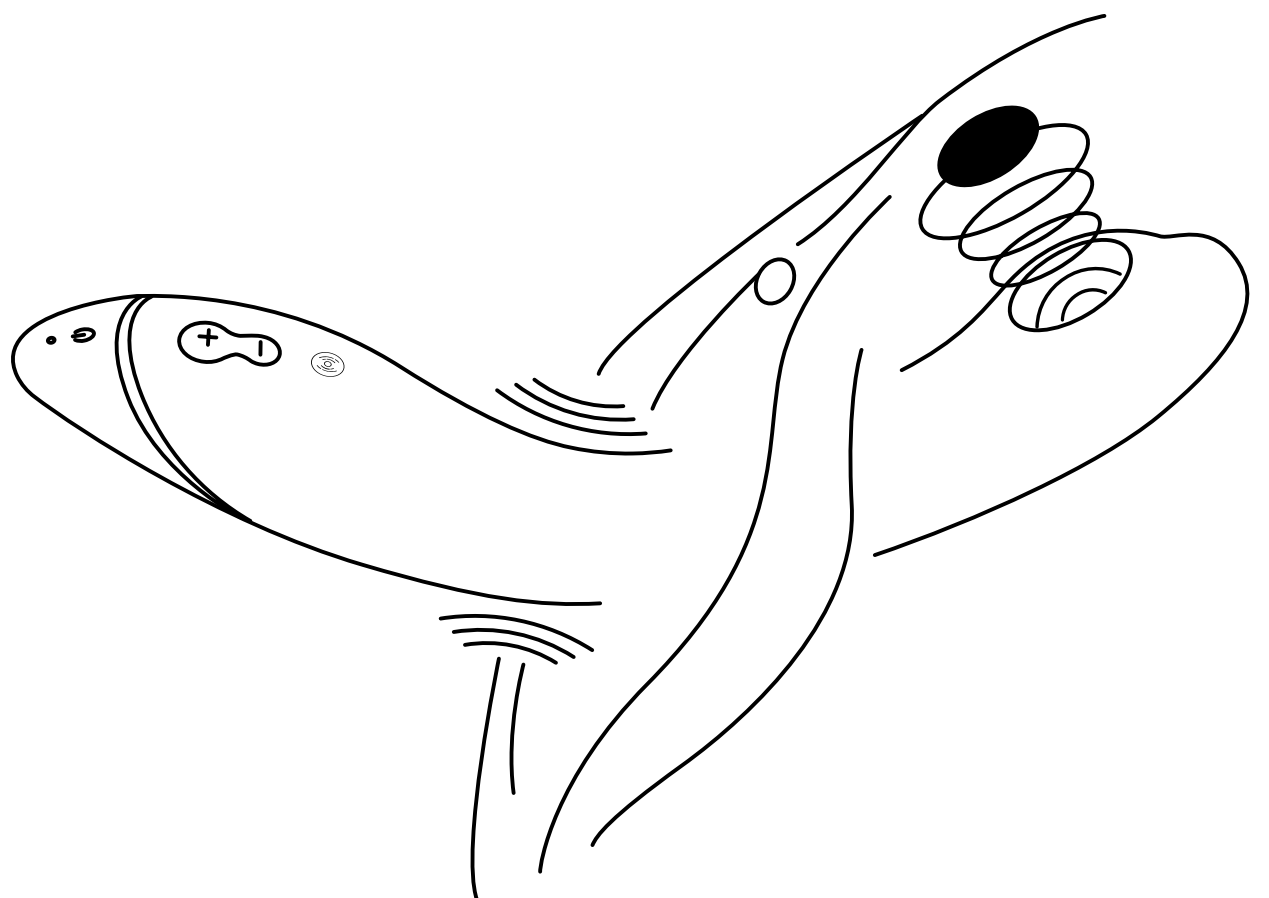
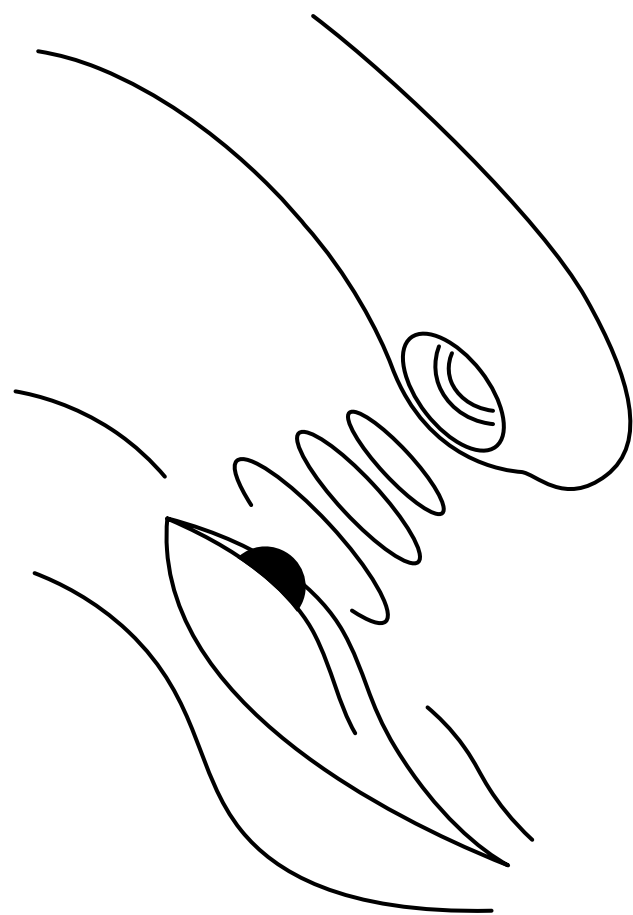

# КАК ПОЛЬЗОВАТЬСЯ

## 3. Регулируйте интенсивность

**Увеличить** —  
Нажмите и отпустите.  
**12 уровней интенсивности**

**Увеличить** —  
Нажмите и отпустите.  
**3 уровня вибрации**

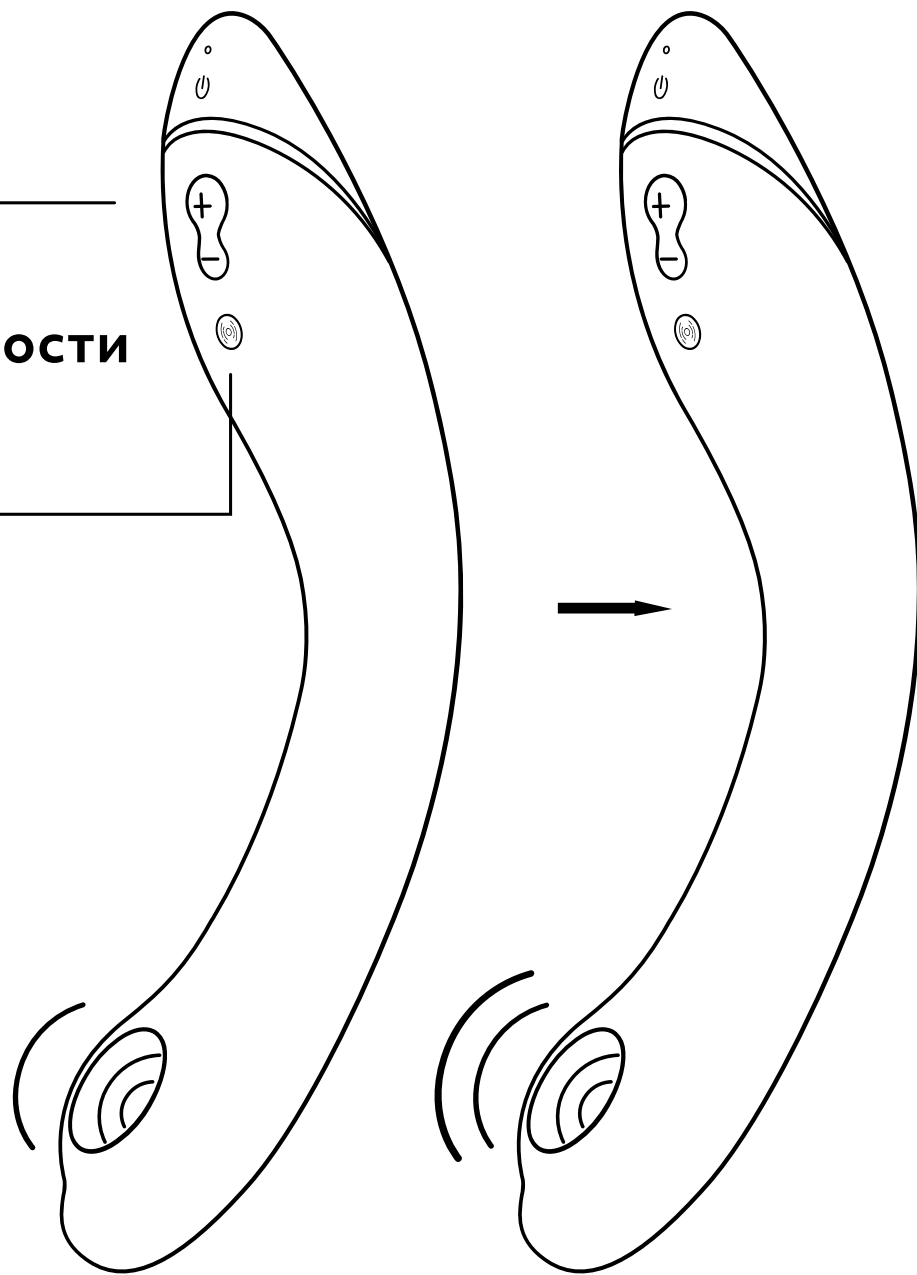

**Уменьшить** —  
Нажмите и отпустите.

**Afterglow**  
Нажмите (-) и  
удерживайте в течение  
1 секунды, чтобы  
вернуться к уровню  
интенсивности 1.



# КАК ПОЛЬЗОВАТЬСЯ

## 4. Выключение

Нажмите и удерживайте в течение 2 секунд

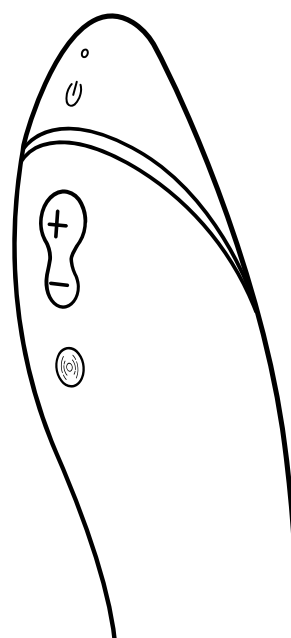

## SMART SILENCE

**OG** включается, только когда почти касается кожи. Smart Silence включается по умолчанию. Нажмите и удерживайте кнопки «плюс» и «минус» в течение 2 секунд, чтобы включить или выключить Smart Silence.

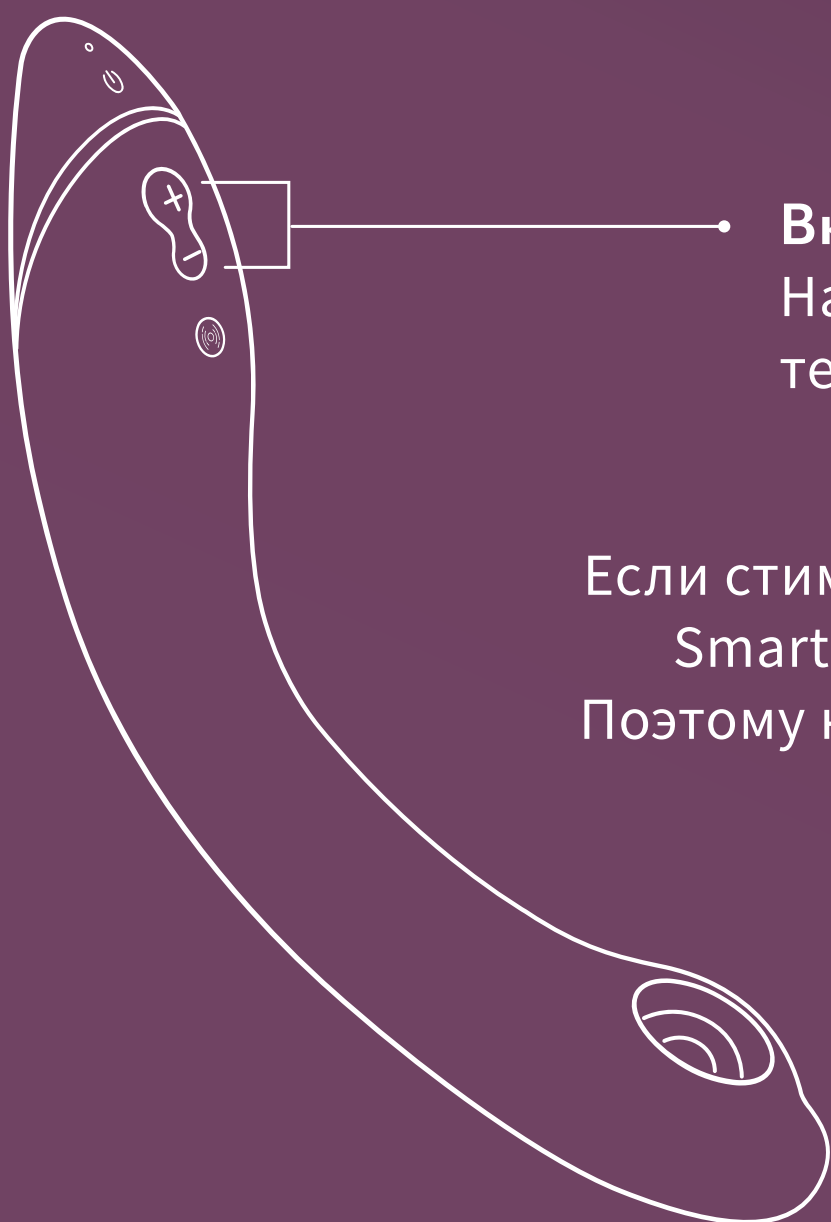

**Включение/выключение**  
Нажмите и удерживайте в течение 2 секунд

Если стимулирующая головка влажная, Smart Silence может не работать. Поэтому никогда не наносите смазку на головку Pleasure Air.

# ЧИСТКА

Промойте водой.

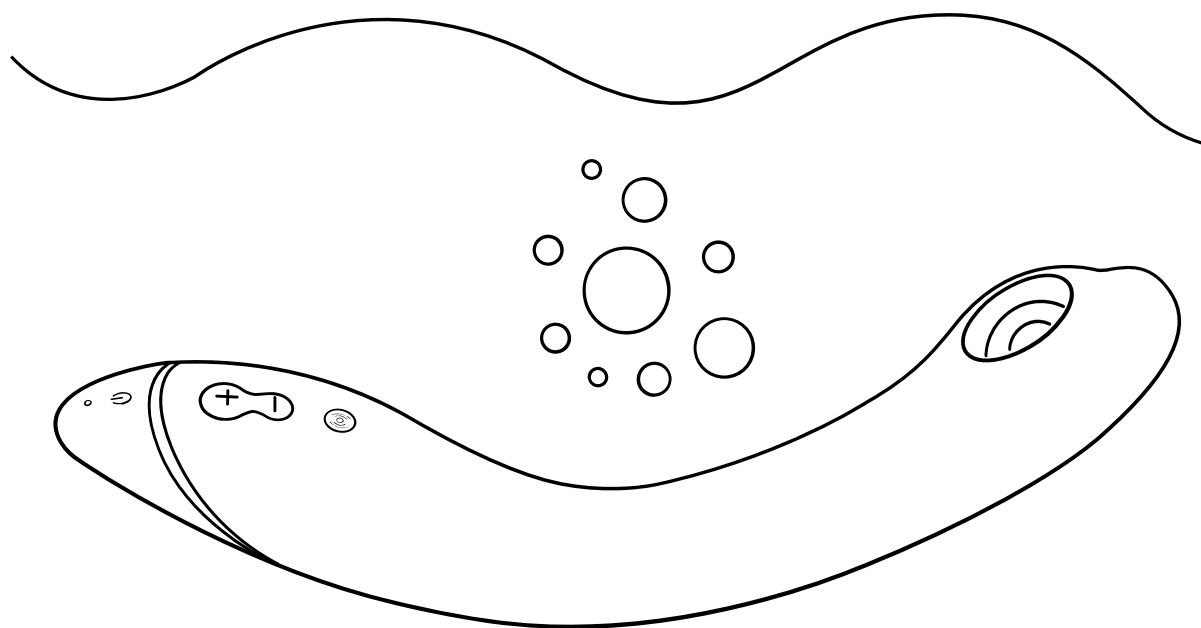

Нанесите средство для мытья игрушек.

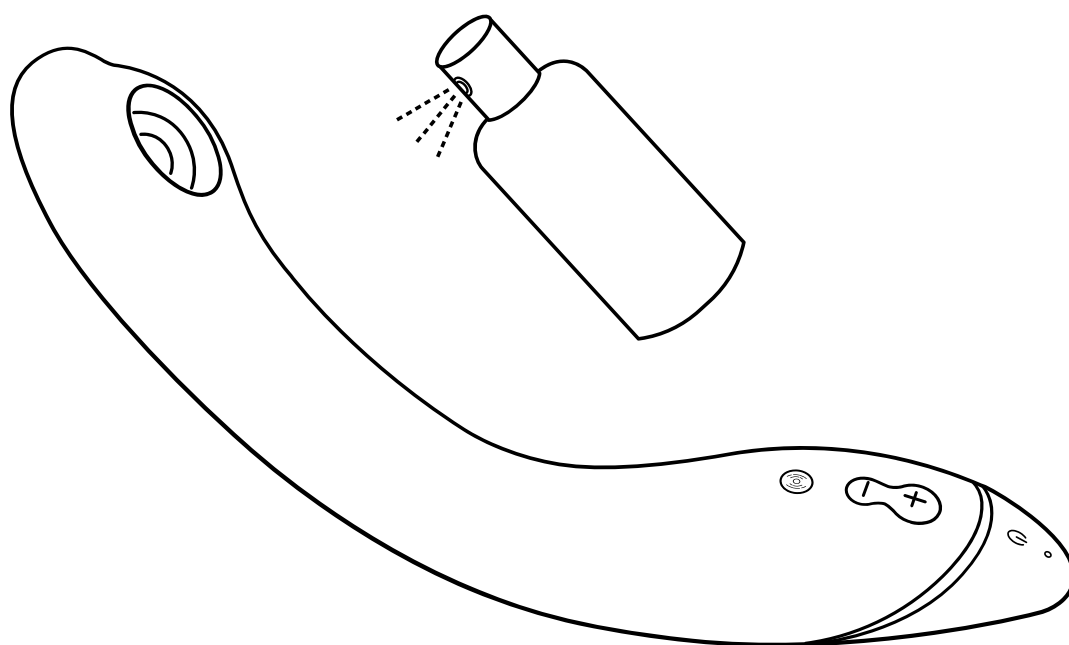

Аккуратно протрите насухо, не надавливая на мембрану слишком сильно.

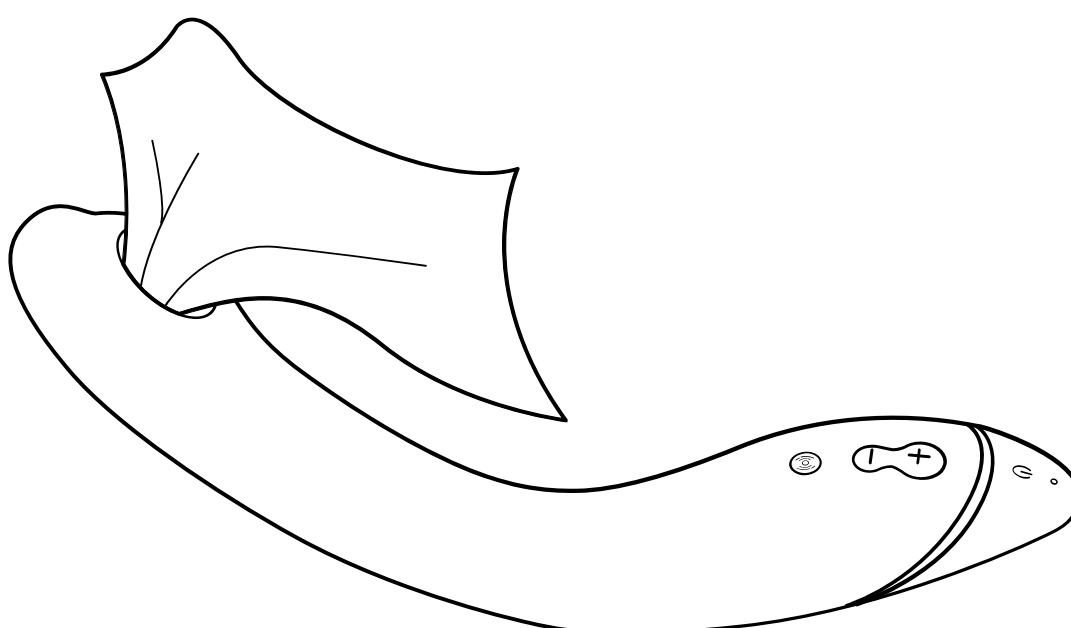

Водонепроницаемый корпус (IPX7)

# ЗАРЯДКА

Зарядите **OG** перед первым использованием.  
Не забывайте регулярно заряжать **OG**,  
чтобы продлить срок службы батареи.

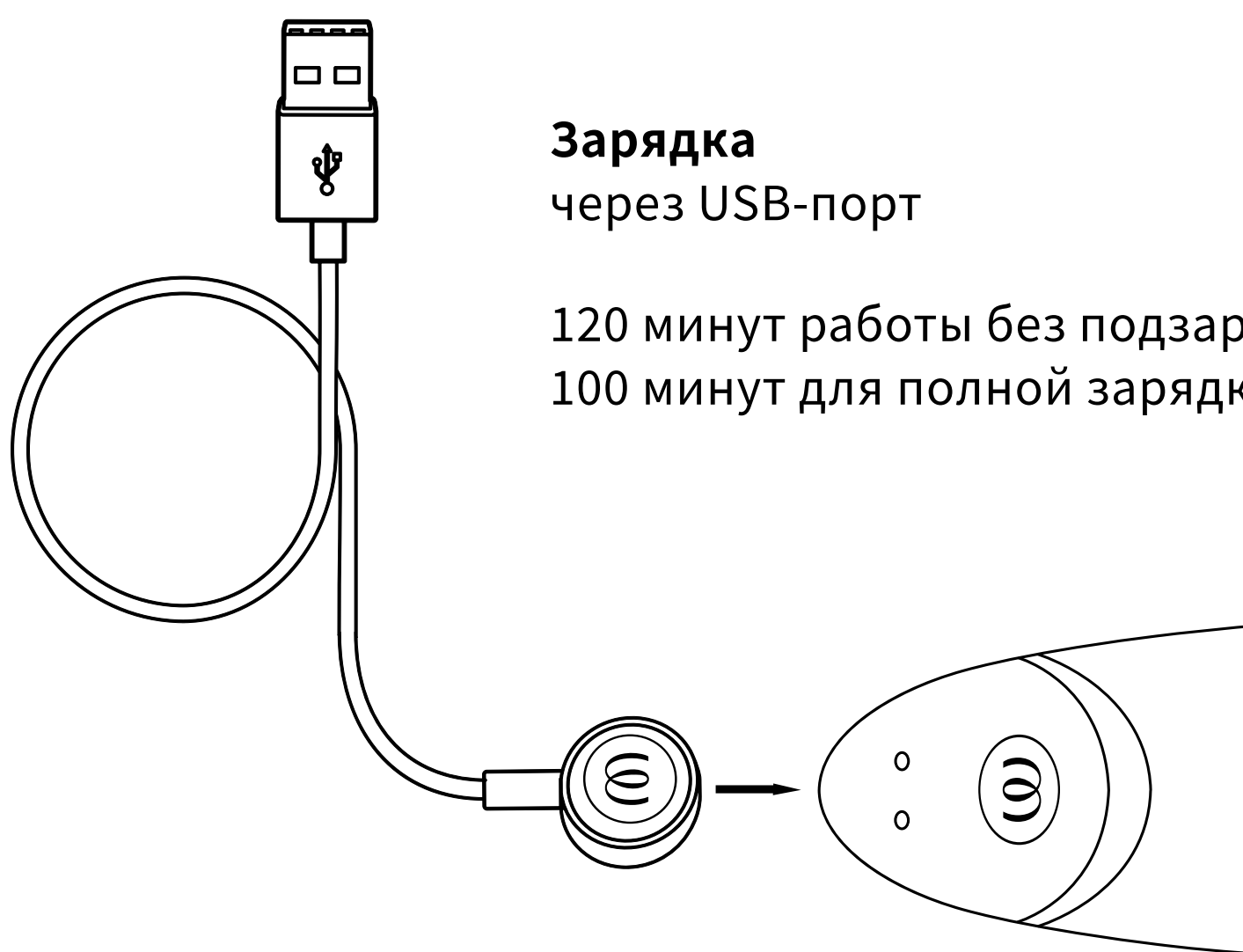

**Зарядка**  
через USB-порт

120 минут работы без подзарядки  
100 минут для полной зарядки

---

**Светодиодный индикатор**  
Включен/выключен/зарядка

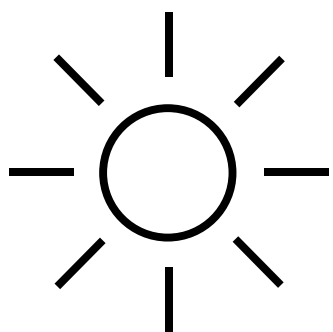

**Полностью заряжен**  
Светодиодный индикатор  
горит постоянно

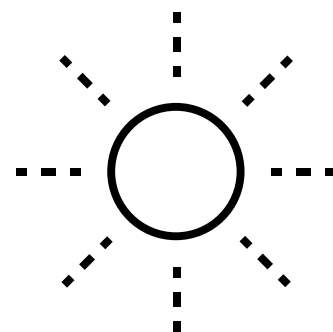

**Зарядка**  
Светодиодный индикатор  
мигает

# НЕСКОЛЬКО ХИТРОСТЕЙ

чтобы получить удовольствие с помощью  
**WOMANIZER OG**



Точка G была названа так в честь врача Эрнста Грэфенберга. Название прижилось, но теперь уже известно, что точка G — это скорее не «точка», а большая зона внутренней части клитора, которую можно стимулировать изнутри влагалища.

То есть точка G скрыта за передней стенкой влагалища и менее чувствительна, чем наружная часть клитора.

Поскольку точка G скрыта, на ее стимуляцию нужно больше времени. Она увеличивается в размерах, становится более чувствительной и восприимчивой к стимуляции при возбуждении.

Оргазм точки G — это совершенно незабываемые ощущения. Для его достижения потребуется немного времени и усилий, но кульминация в результате приносит огромное удовлетворение и абсолютно отличается от всего когда-либо испытанного вами.



# ОПЫТ

Не торопитесь, не прекращайте свои исследования.

Нанесите смазку на водной основе на корпус **OG**.

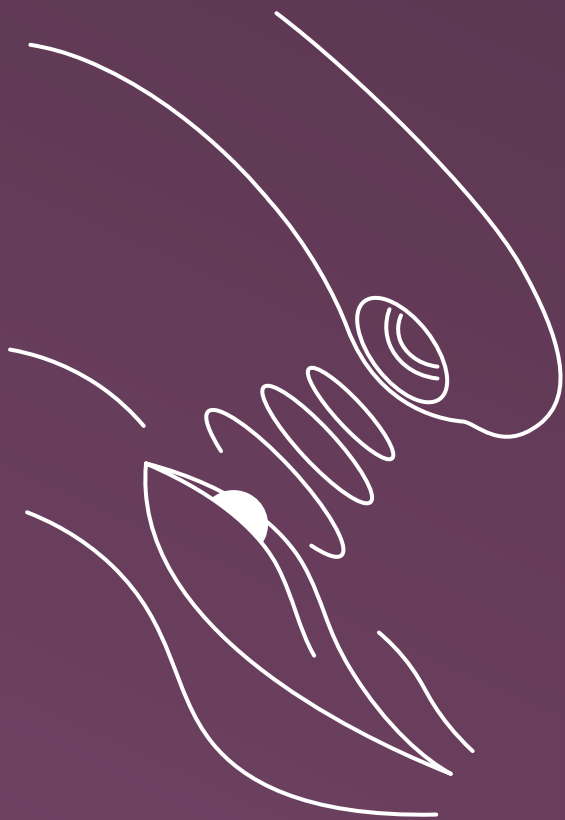

Настройтесь на игривый лад и начните с внешней стимуляции с помощью **Pleasure Air**.



Перейдите к внутренней стимуляции с помощью **Pleasure Air**, добавив вибрацию.

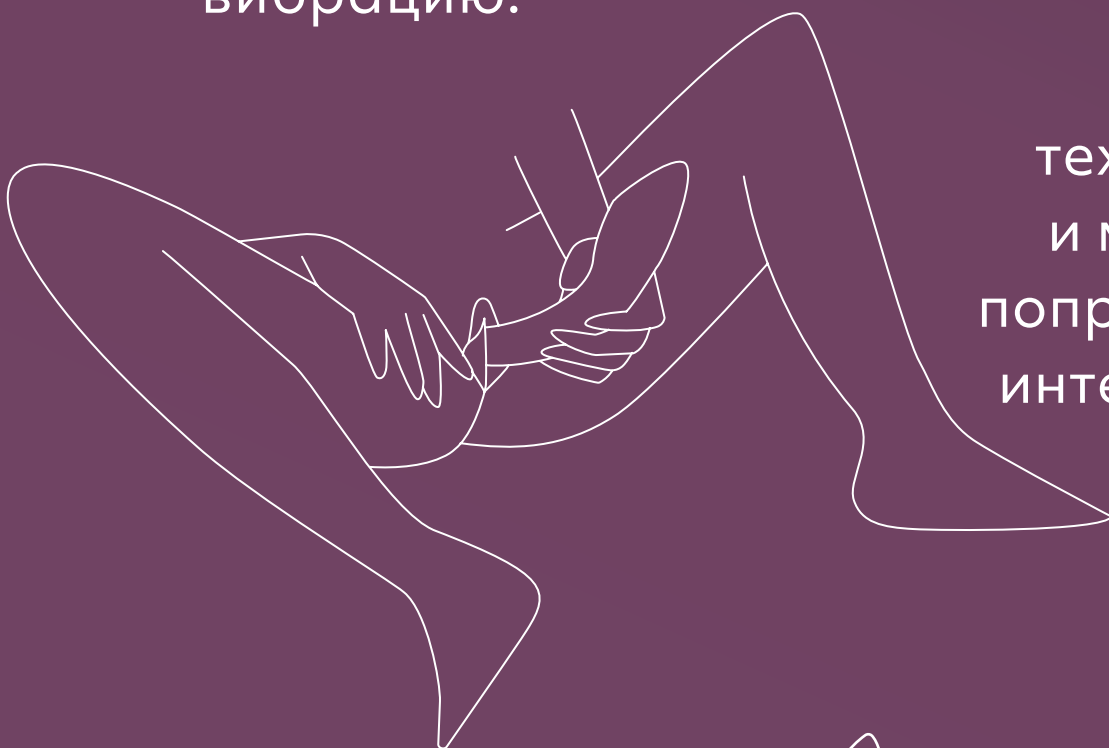

**OG** сочетает в себе стимуляцию с использованием технологии **Pleasure Air** и мощных вибраций — попробуйте разные уровни интенсивности и вибрации для достижения уникальных ощущений при оргазме.

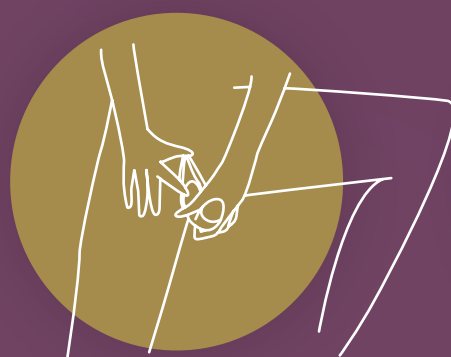
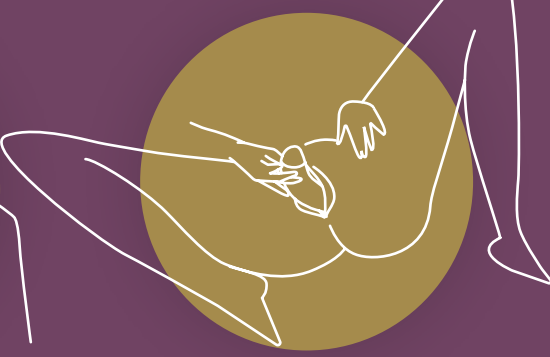
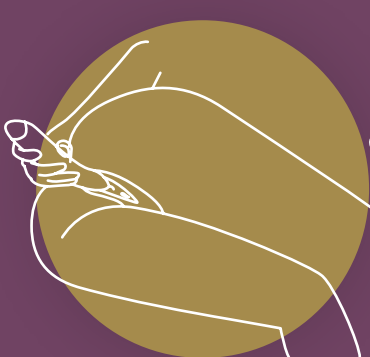

# ВНИМАНИЕ

## ЗАРЯДКА

Изделие продается только в качестве нового. Используйте прибор исключительно по назначению. Храните изделие в местах, недоступных для детей. Не предусмотрено для использования в медицинских целях. Если Вы находитесь под наблюдением врача и / или Ваше состояние здоровья требует использования какого-либо медицинского устройства, то перед использованием данного изделия Вам необходимо проконсультироваться с врачом. Немедленно прекратите использование изделия в том случае, если появятся раздражения кожи или Вы начнете испытывать боль или дискомфорт, и обязательно обратитесь к врачу.

Данный прибор предназначен для использования только взрослыми лицами, а также лицами с ограниченными физическими, сенсорными или умственными способностями, или с отсутствием опыта и знаний при условии, что они получили инструкции относительно безопасного использования прибора и понимают связанные с его использованием риски. Детям запрещено играть с прибором, а также чистить его или мыть. Не используйте прибор на опухших или воспаленных участках кожи.

- Перед использованием снимите пирсинг или украшения в интимной зоне.
- Всегда очищайте изделие до и после использования в соответствии с инструкциями, приведенными в руководстве.
- Во избежание возникновения повреждений не подвергайте изделие и его аккумулятор воздействию температур выше 45°C, демонтажу, а также механическим или электрическим повреждениям.
- Совместное использование секс-игрушек может привести к передаче заболеваний половым путем. Не используйте секс-игрушки совместно с другими пользователями, за исключением вашего полового партнера. При необходимости используйте средства защиты. Не используйте секс-игрушку, если вы обнаружите на ее поверхности какие-либо трещины или признаки повреждения.
- Данный прибор не предназначен для анального использования. Не используйте прибор анально!
- Избегайте соприкосновения мягкой части прибора с абсорбирующими поверхностями во избежание появления пятен.
- Регулярно проверяйте зарядное устройство и изделие на предмет наличия повреждений и не используйте изделие в том случае, если какие-либо его компоненты повреждены.
- Магнитные поля могут влиять на механические и электронные компоненты, например, кардиостимулятор. Не используйте изделие вблизи кардиостимулятора. Для получения дополнительной информации обратитесь к своему лечащему врачу. Карты с магнитной полоской (например, кредитные карты) не должны находиться вблизи изделия, поскольку они могут быть повреждены находящимся в изделии магнитом.
- Если в работе изделия наблюдаются сбои, то вам следует выключить его и обратиться в службу поддержки, контактные данные которой указаны на нашем веб-сайте.

## ЗАРЯДКА

- Перед первым использованием зарядного устройства проверьте уровень местного напряжения. Местное сетевое напряжение не должно превышать максимальное сетевое напряжение, указанное на зарядном устройстве.
- Прибор следует заряжать только при безопасном сверхнизком напряжении, соответствующем маркировке на приборе.
- Не используйте и не чистите прибор во время зарядки аккумулятора.
- Никогда не погружайте зарядное устройство или зарядный кабель в воду или другие жидкости.
- Данный прибор содержит аккумуляторные батареи, не подлежащие замене.
- Данный прибор оснащен перезаряжаемой литий-ионной аккумуляторной батареей.
- Отключайте зарядный кабель от сети после каждого процесса зарядки.

## ДЛЯ ОПТИМАЛЬНОГО ИСПОЛЬЗОВАНИЯ ИЗДЕЛИЯ СЛЕДУЙТЕ СЛЕДУЮЩИМ РЕКОМЕНДАЦИЯМ:

- Чтобы гарантировать длительное время автономной работы, необходимо регулярно заряжать изделие, даже если вы не используете его.
- Храните прибор в защищенном, сухом месте, избегая воздействия прямых солнечных лучей.
- Мы рекомендуем использовать смазку на водной основе. Во избежание повреждений не следует использовать ароматизированные или силиконовые смазки, смазки на спиртовой основе, а также гели или массажные масла.

# GENERAL INFORMATION

## ELECTRICAL RATING

**Model:** OG

**Model No.:** TES10A

**Power Input:**

3,7 V=0,62 A: Built-in Li-Polymer rechargeable battery.

5 V=0,5 A: When charged using USB.

Use USB AC adaptor (not included) with power output corresponding to product rating. Use original provided cable only."

## CONTENT OF DELIVERY

Womanizer OG G-Spot vibrator, USB charging cable (AC adapter not included), cotton storage pouch, quick start guide, safety instructions

## ENVIRONMENTAL PROTECTION

As a distributor of electronic devices, we are legally obliged to accept the return of waste electrical and electronic devices free of charge. We expressly state that you as the user are legally obliged to return used batteries.

Never throw away electronic devices or batteries in the household waste. The symbol shown below (crossed-out wheeled bin) is intended to expressly remind you of this.

## MANUFACTURED AND DISTRIBUTED BY

**WOW Tech Europe GmbH**

Hermann-Blankenstein-Strasse 5

10249 Berlin

[www.wowtech.com](http://www.wowtech.com)

WOW Tech Europe GmbH reserves the right to make technical changes and changes to the design that serve to improve the device.

For information regarding patents see [womanizer.com/patents](http://womanizer.com/patents).

## CUSTOMER CARE

[care@womanizer.com](mailto:care@womanizer.com)

[womanizer.com](http://womanizer.com)

Designed in Germany. Made in China.

Date of issue: 10/2022.



# ХОЧЕТСЯ БОЛЬШЕГО?

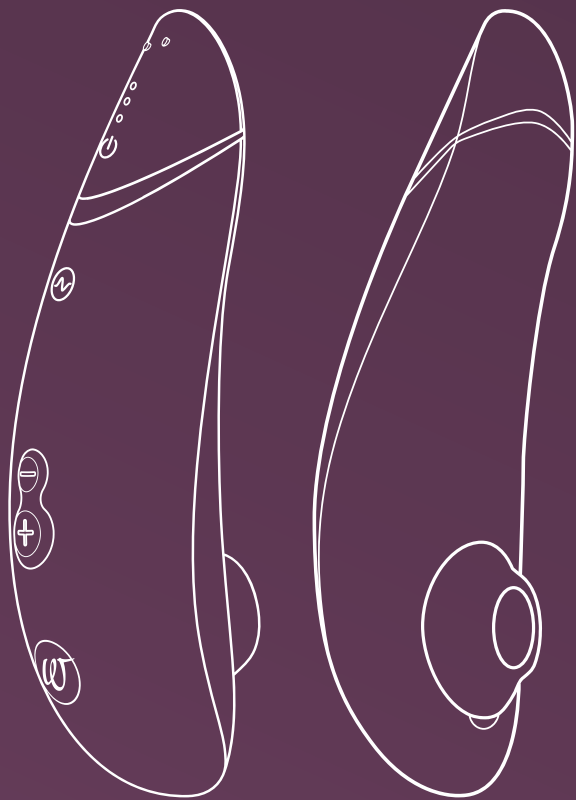

Технология  
Pleasure Air



Autopilot



Функция  
Smart Silence

**Premium 2**  
Define your luxury

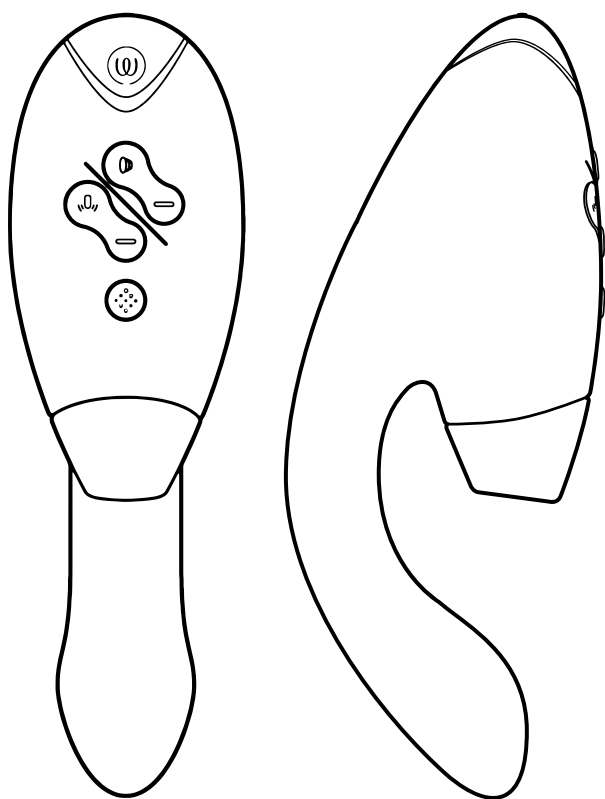

Технология  
Pleasure Air



Двойная стимуляция



Функция  
Smart Silence

**DUO 2**  
Indulge in whole-body orgasms



#IMASTURBATE

# Hi!

Datum vy Dziękujemy za wybranie produktu **WOMANIZER OG**.

Witamy w świecie pełnym zmysłowych doznań, które wzbogacą Twoje życie. Wybierając **WOMANIZER**, masz gwarancję nie tylko rewelacyjnych orgazmów, ale też możliwość poznania zupełnie nowego apetytu na rozkosz.

Ciesz się urządzeniem **WOMANIZER OG** i przeżywaj jeden orgazm po drugim.

Daj sobie trochę miłości!



**OPIS**

**SPOSÓB UŻYCIA**

**FUNKCJA SMART SILENCE**

**CZYSZCZENIE**

**ŁADOWANIE**

**SAFETY INSTRUCTIONS**

**INFORMACJE OGÓLNE**

Please read the safety instructions in the  
Compliance & Safety Information before first use.



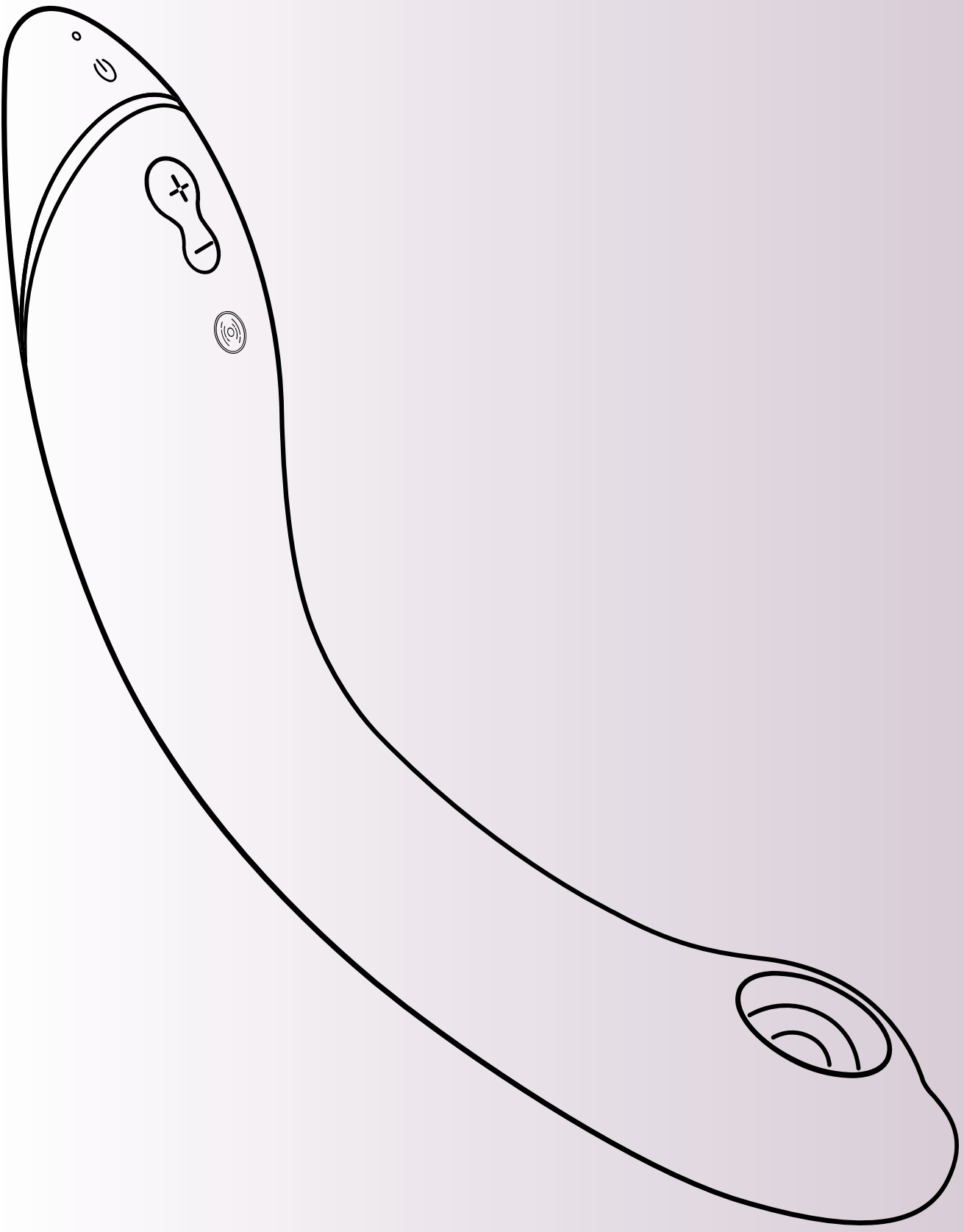



# OPIS

**Wyświetlacz LED**  
Włączanie/Ładowanie

**Włączanie i  
wyłączanie funkcji  
Smart Silence**  
Przytrzymaj przez  
2 sekundy

**Wibracje**  
Naciśnij krótko,  
aby aktywować  
i zwiększyć  
intensywność  
(3 poziomów)

**Pleasure Air Technology**  
(12 poziomów)

**Włączanie/Wyłączanie**  
Przytrzymaj przez  
2 sekundy

**Zwiększanie intensywności**  
Krótko naciśnij (+)

**Zmniejszanie intensywności**  
Krótko naciśnij (-)

**Funkcja Afterglow**  
Przytrzymaj (-) przez  
1 sekundę



# SPOSÓB UŻYCIA

## 1. Włączanie

Przytrzymaj przez 2 sekundy. Dioda LED wskaże, że produkt jest włączony.

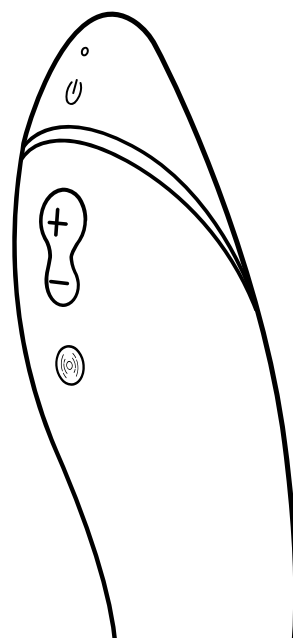

## 2. Korzystanie

Aby wprowadzić się w nastrój, najpierw użyj gadżetu **OG** na łechtaczce.

Nałóż lubrykant na bazie wody na wibrator **OG**.

Gdy się rozgrzejesz, włóż gadżet **OG** i zajmij się swoim punktem G!

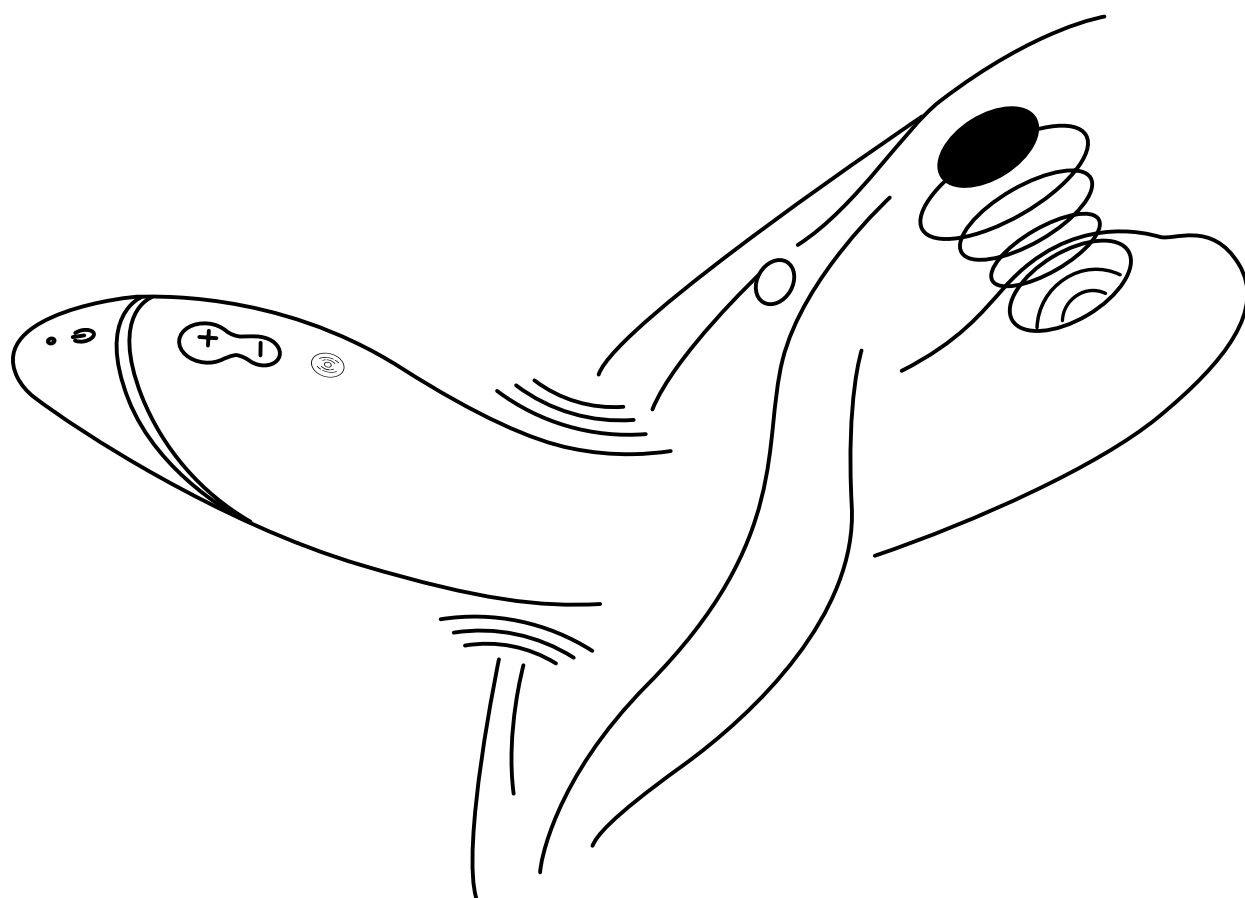
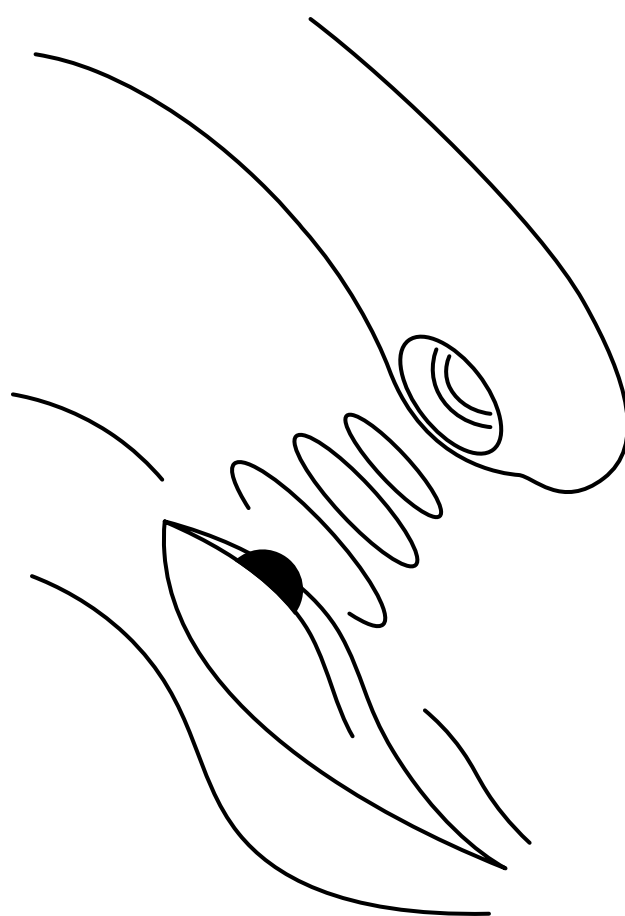

# SPOSÓB UŻYCIA

## 3. Zmień intensywność

**Zwiększ** —  
Naciśnij krótko  
**12 poziomów intensywności**

**Zwiększ** —  
Naciśnij krótko  
**3 poziomy wibracji**

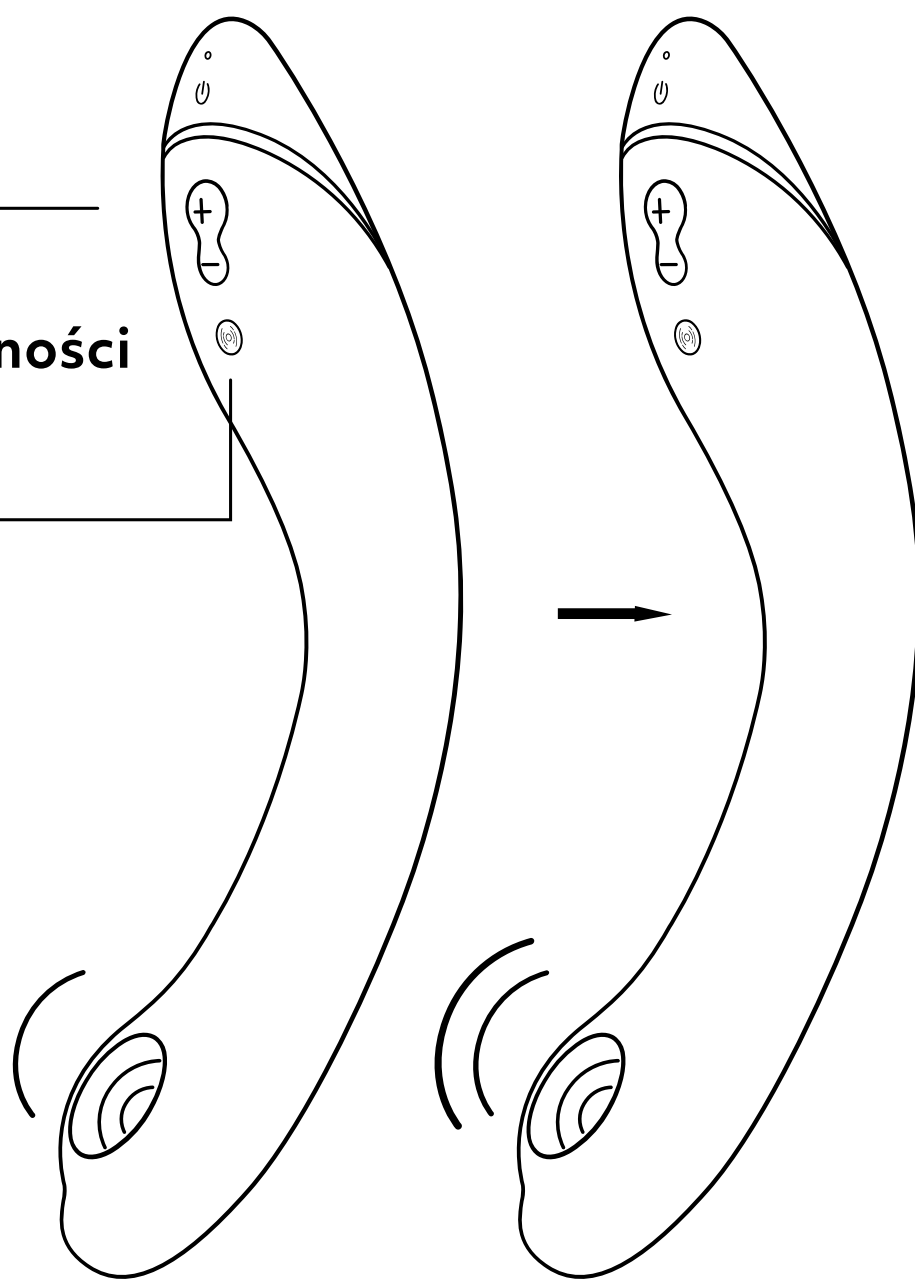

**Zmniejsz** —  
Naciśnij krótko

**Funkcja Afterglow**  
Naciśnij (-) przez  
1 sekundę, aby  
powrócić do poziomu  
intensywności 1

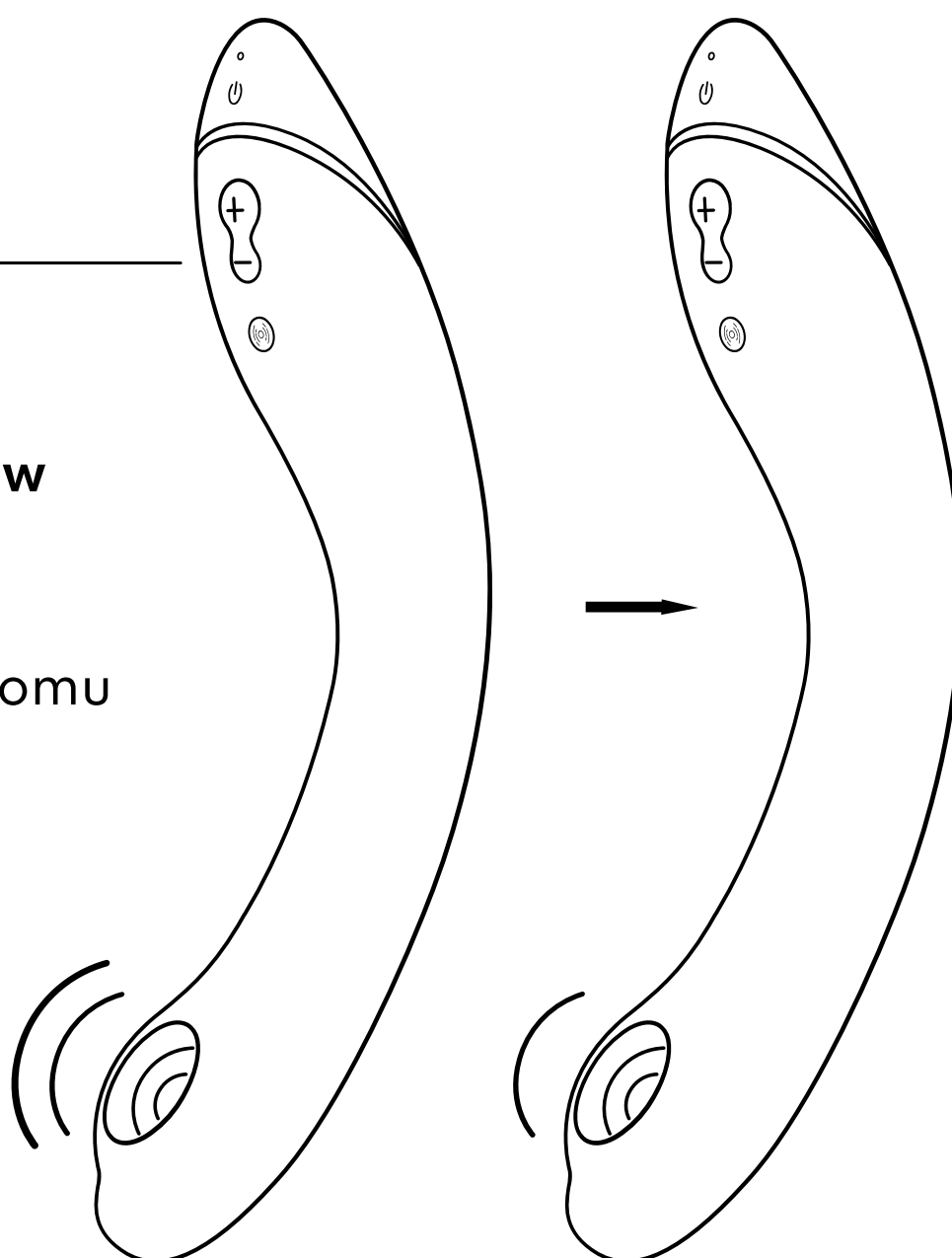

# SPOSÓB UŻYCIA

## 4. Wyłączanie urządzenia

Przytrzymaj przez  
2 sekundy

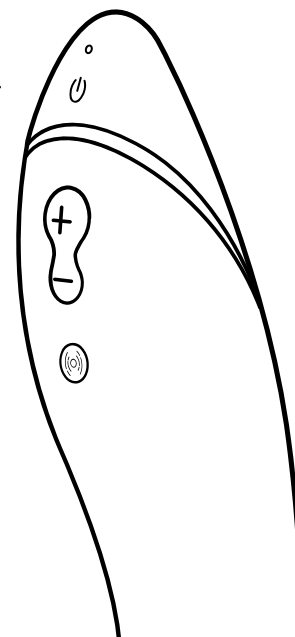

## FUNKCJA SMART SILENCE

Gadżet **OG** włącza się tylko wtedy, gdy prawie dotyka Twojej skóry. Funkcja Smart Silence będzie automatycznie włączona. Aby włączyć lub wyłączyć funkcję Smart Silence, naciśnij i przytrzymaj przez 2 sekundy przyciski plus i minus.

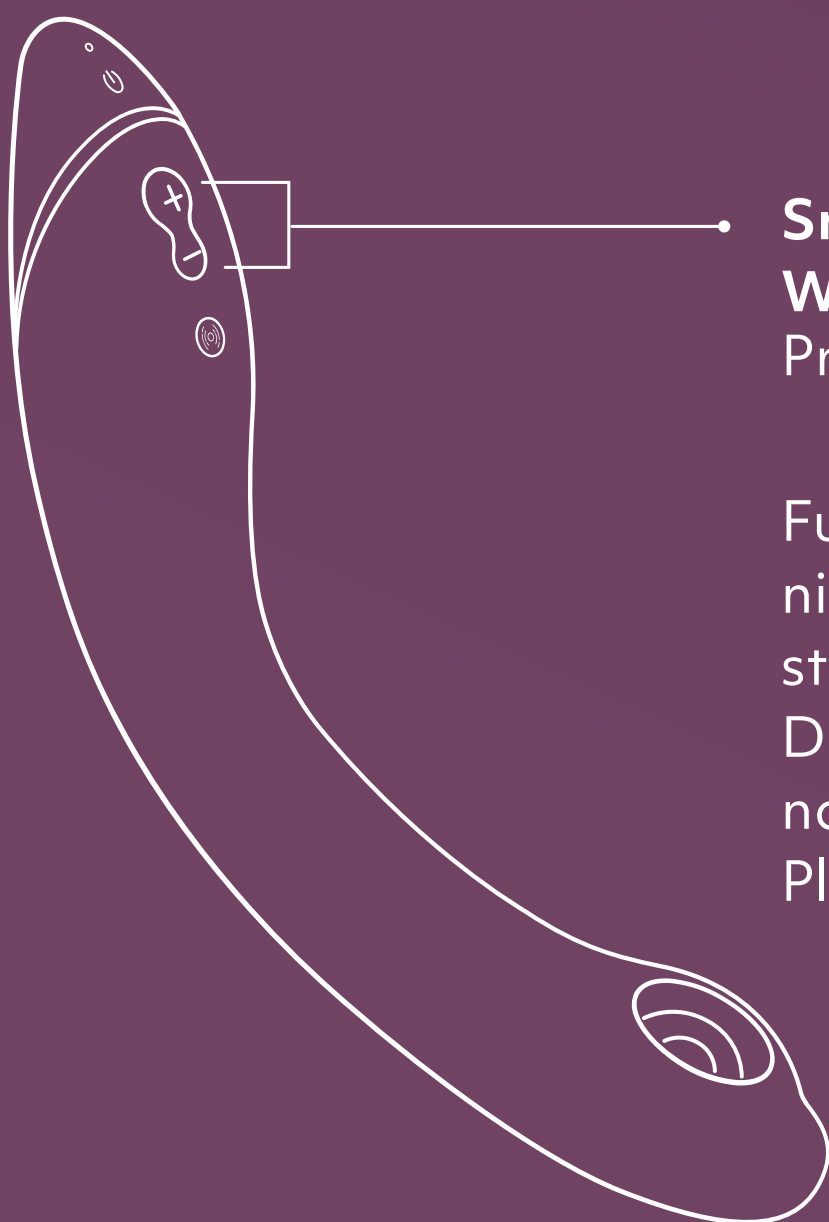

### Smart Silence

#### Włączanie/Wyłączanie

Przytrzymaj przez 2 sekundy

Funkcja Smart Silence może nie działać, gdy głowica stymulująca jest mokra. Dlatego należy uważać, aby nie nakładać lubrykantu na głowicę Pleasure Air.

# CZYSZCZENIE

Myj pod wodą.

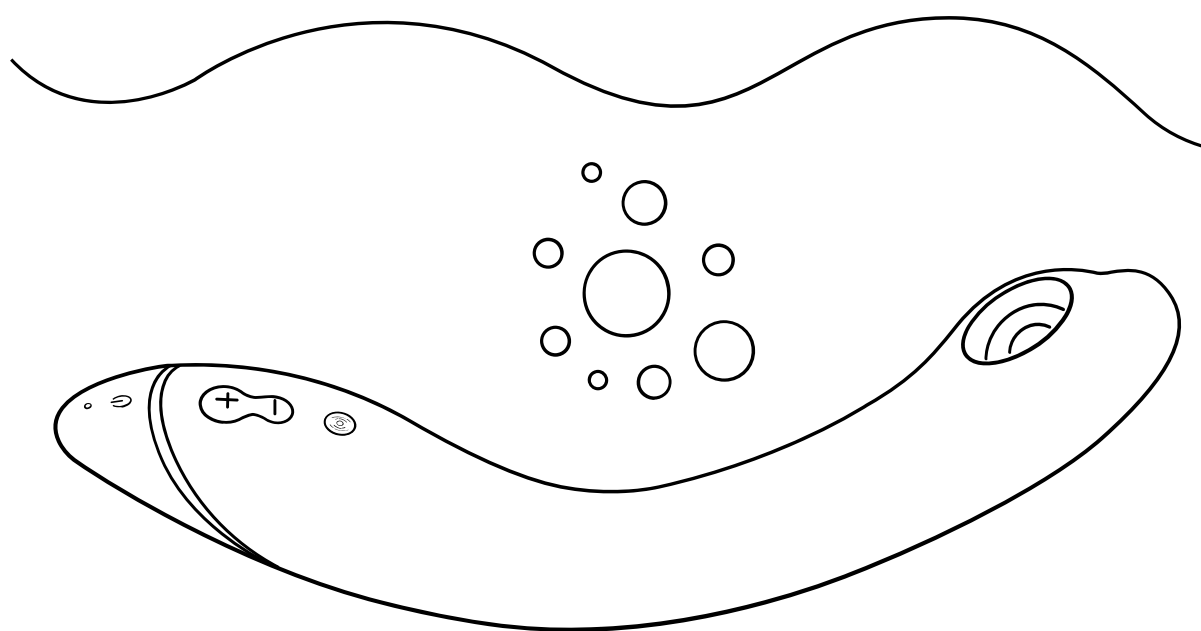

Użyj płynu do czyszczenia gadżetów erotycznych.

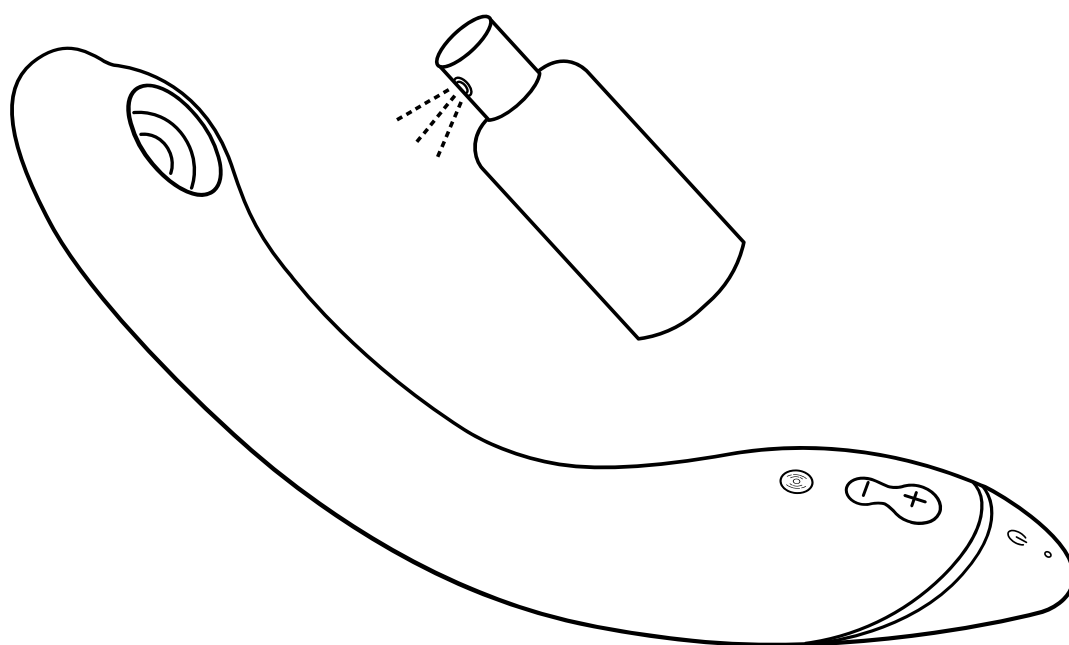

Wysusz ostrożnie, nie wywierając zbyt dużego nacisku na membranę.

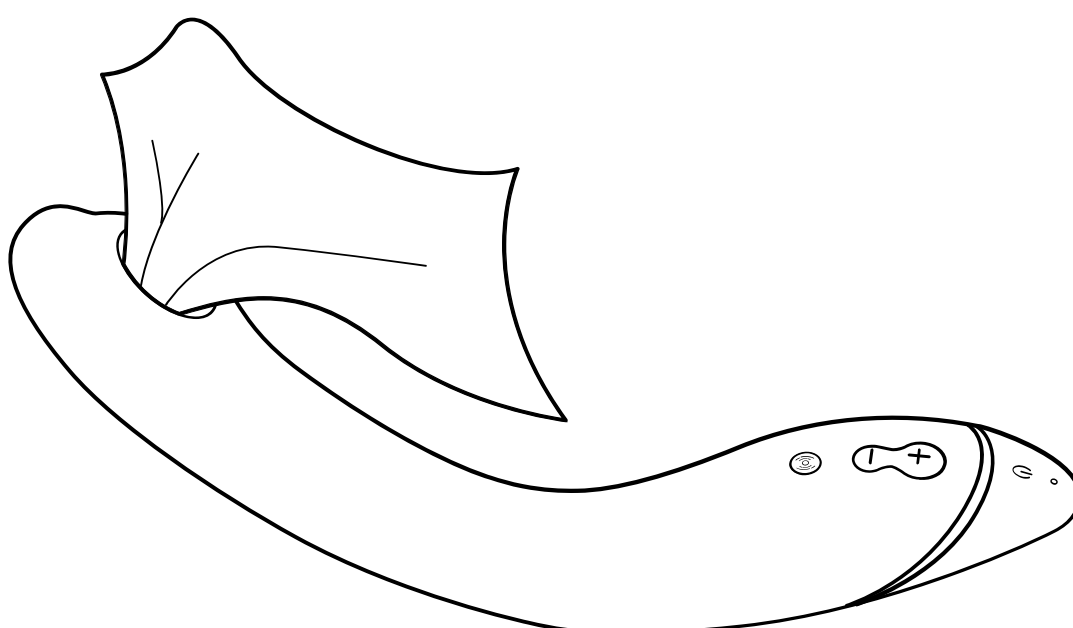

Wodoodporność  
(IPX7)

# ŁADOWANIE

Naładuj gadżet **OG** przed pierwszym użyciem. Aby zapewnić długą żywotność baterii, ładuj gadżet **OG** regularnie.

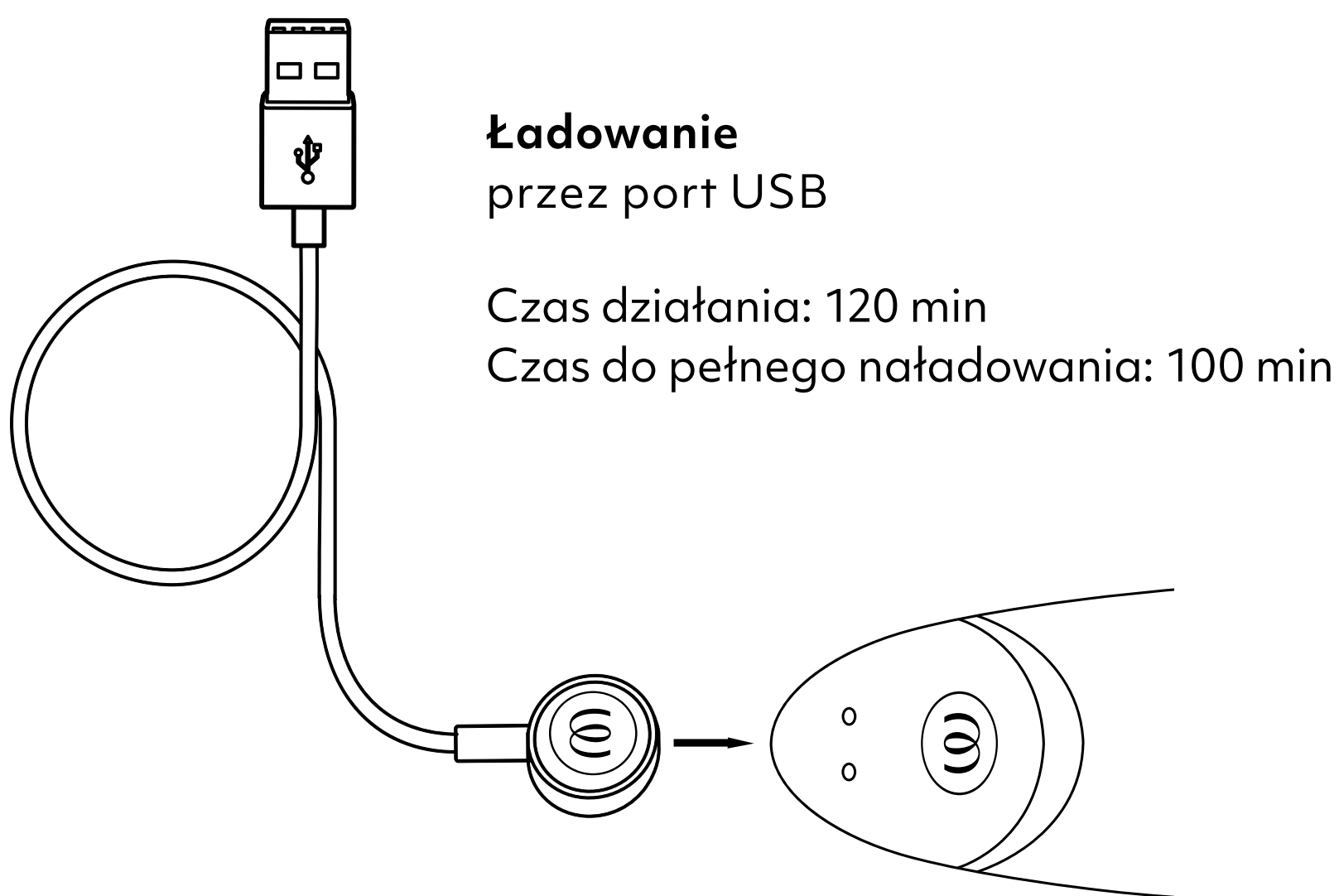

**Ładowanie**  
przez port USB

Czas działania: 120 min

Czas do pełnego naładowania: 100 min

---

## LED

Włączanie/Wyłączanie/Ładowanie

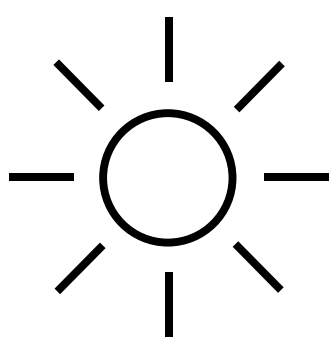

**Urządzenie w pełni  
naładowane**  
Dioda LED świeci w  
sposób ciągły

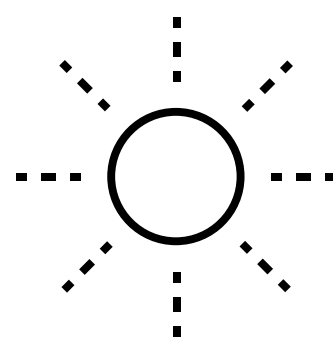

**Ładowanie**  
Dioda LED miga

# SAFETY INSTRUCTIONS

## OSTRZEŻENIE

Produkt sprzedawany wyłącznie do celów rozrywkowych. Produkt może być używany tylko zgodnie z przeznaczeniem. Trzymaj produkt z dala od dzieci. Nieodpowiedni do użytku medycznego. Jeśli jesteś pod opieką lekarską i/lub Twój stan wymaga korzystania z jakiegokolwiek sprzętu medycznego, przed użyciem tego produktu skonsultuj się z lekarzem. Natychmiast zaprzestań korzystania z produktu w przypadku wystąpienia podrażnień skóry, bólu lub uczucia dyskomfortu i skonsultuj się z lekarzem.

Z urządzenia mogą korzystać wyłącznie osoby dorosłe, a także osoby o obniżonej sprawności fizycznej, sensorycznej lub umysłowej bądź osoby nieposiadające wystarczającej wiedzy i doświadczenia, jeśli pozostają pod nadzorem lub zostały przeszkolone w zakresie bezpiecznego korzystania z urządzenia i rozumieją ewentualne ryzyko. Dzieci nie mogą bawić się urządzeniem. Czyszczenie i konserwacja nie mogą być dokonywane przez dzieci. Nie stosować na spuchnięte ani zaognione obszary skóry.

- Przed użyciem zdejmij kolczyki i biżuterię z okolic narządów płciowych.
- Przed użyciem i po użyciu produktu należy zawsze go wyczyścić zgodnie z instrukcją obsługi.
- Aby uniknąć uszkodzenia produktu, nie należy wystawiać produktu ani baterii na działanie temperatur powyżej 45°C, demontować ani narażać na uszkodzenia mechaniczne lub elektryczne.
- Współdzielenie zabawek seksualnych może prowadzić do transmisji chorób przenoszonych drogą płciową. Nie należy współdzielić zabawek seksualnych z żadną osobą z wyjątkiem partnera/partnerki. Jeśli to konieczne, należy stosować z partnerem/partnerką środki ochronne. Nie używać zabawki w przypadku wykrycia pęknięć lub oznak uszkodzenia powłoki.
- Produkt nie jest przeznaczony do stosowania analnego. Nie stosować analnie!
- Nie kłaść produktu miękką stroną na chłonnej powierzchni, aby uniknąć plam.
- Należy regularnie sprawdzać ładowarkę i produkt pod kątem uszkodzeń i nie korzystać z urządzenia, jeśli jakiegokolwiek elementy uległy uszkodzeniu.
- Pola magnetyczne mogą wpływać na elementy mechaniczne i elektroniczne, takie jak rozruszniki serca. Nie używaj urządzenia bezpośrednio nad rozrusznikiem serca. Aby uzyskać więcej informacji, skontaktuj się z lekarzem. Nie należy zbliżać do urządzenia kart z paskiem magnetycznym (np. kart kredytowych), ponieważ mogą one zostać uszkodzone przez magnesy zawarte w produkcie.
- Jeśli zabawka wydaje się działać nieprawidłowo, należy ją wyłączyć i skonsultować się z sekcją wsparcia na naszej stronie internetowej.

## ŁADOWANIE

- Przed pierwszym ładowaniem urządzenia należy sprawdzić lokalny poziom napięcia, ponieważ lokalne napięcie sieciowe nie może przekraczać maksymalnego napięcia sieciowego wskazanego na ładowarce.
- Urządzenie może być ładowane tylko z użyciem bezpiecznego bardzo niskiego napięcia, zgodnie z oznaczeniem na urządzeniu.
- Nie należy używać ani czyścić produktu podczas ładowania baterii.
- Nigdy nie zanurzać ładowarki ani przewodu ładującego w wodzie ani innych płynach.
- To urządzenie zawiera niewymienne baterie.
- Ten produkt zawiera akumulator litowo-jonowy.
- Po każdym ładowaniu należy odłączyć przewód ładujący od obwodu.

## W CELU PRAWIDŁOWEGO KORZYSTANIA Z PRODUKTU NALEŻY PRZESTRZEGAĆ PONIŻSZYCH WSKAZÓWEK:

- Aby zapewnić długą żywotność baterii, należy regularnie ładować urządzenie, nawet jeśli jest nieużywane.
- Przechowywać w bezpiecznym, suchym miejscu, nie wystawiając na bezpośrednie działanie promieni słonecznych.
- Podczas korzystania z produktu zalecamy używanie lubrykantu na bazie wody. Aby uniknąć uszkodzeń produktu, nie należy używać lubrykantów perfumowanych, na bazie silikonu lub alkoholu, żeli ani olejków do masażu.

## UWAGI DOTYCZĄCE BATERII

Ze względu na przepisy europejskie jesteśmy zobowiązani do podania następujących informacji:

- Baterie i akumulatory nie mogą być wyrzucane do odpadów domowych. Jako użytkownik końcowy są Państwo prawnie zobowiązani do zwrotu zużytych baterii. W tym celu należy korzystać z oficjalnych punktów zbiórki, takich jak punkty zbiórki firm zajmujących się usuwaniem odpadów. Zużyte baterie, które sprzedajemy lub sprzedaliśmy jako nowe, mogą być również zwrócone do nas. Prosimy o kontakt z nami w tej sprawie pod adresem [care@womanizer.com](mailto:care@womanizer.com). Aby uniknąć zwarć, należy zakleić bieguny baterii litowych przed ich zwrotem. Ze względów bezpieczeństwa prosimy o niewysyłanie do nas baterii pocztą i odsyłamy do przepisów dotyczących przesyłania towarów niebezpiecznych przez przedsiębiorstwa pocztowe.
- Jeśli baterie są na stałe zainstalowane w produkcie, pod żadnym pozorem nie należy próbować ich samodzielnie demontować. Może to spowodować trwałe uszkodzenie urządzenia. Państwa obowiązki jako klienta są również uregulowane w dyrektywie WEEE oraz krajowej ustawie transponującej.
- Aby zapobiec powstawaniu odpadów i zaśmieceniu, należy przestrzegać wskazówek zawartych w instrukcji obsługi oraz instrukcji bezpieczeństwa.
- Zużyte baterie zawierają szkodliwe substancje, które mogą szkodzić środowisku naturalnemu lub zdrowiu ludzi, jeśli nie są odpowiednio przechowywane lub utylizowane. Dotyczy to w szczególności niewłaściwego obchodzenia się z bateriami zawierającymi lit. Baterie zawierają również ważne surowce, takie jak żelazo, cynk, mangan lub nikiel, i mogą być poddawane recyklingowi. Selektywna zbiórka umożliwia powtórne wykorzystanie tych surowców i zapobiega negatywnemu wpływowi uwalnianych zanieczyszczeń na środowisko i zdrowie ludzi.
- Znak z przekreślonym pojemnikiem na śmieci oznacza, że nie wolno wyrzucać baterii i akumulatorów do odpadów domowych.

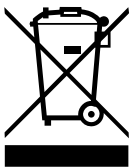

Pod tym symbolem, jeśli spełnione są wymagania prawne, należy przy znakowaniu baterii stosować następujące symbole o następującym znaczeniu:

- Hg: Bateria zawiera więcej niż 0,0005% wagowego rtęci
- Pb: Bateria zawiera więcej niż 0,004% wagowego ołowiu
- Cd: Bateria zawiera więcej niż 0,002% wagowego kadmu

## INFORMACJE NA TEMAT UTYLIZACJI URZĄDZEŃ ELEKTRYCZNYCH

Ze względu na przepisy europejskie jesteśmy zobowiązani do podania następujących informacji:

- Zwracamy uwagę posiadaczom urządzeń elektrycznych, że zgodnie z obowiązującymi przepisami prawa zużyte urządzenia elektryczne należy zbierać oddzielnie od odpadów komunalnych. Baterie i akumulatory, które nie są szczelnie zamknięte w użytym urządzeniu elektrycznym, a także lampki, które można wyjąć ze starego urządzenia bez zniszczenia, należy oddzielić od starego urządzenia w sposób niepowodujący zniszczeń przed przekazaniem go do punktu zbiórki i zutylizować zgodnie z przeznaczeniem. Informacje na temat utylizacji baterii znajdują się w oddzielnej instrukcji. Symbol przekreślonego pojemnika na śmieci pokazany poniżej i umieszczony na zużytych urządzeniach elektrycznych dodatkowo wskazuje na obowiązek selektywnej zbiórki:

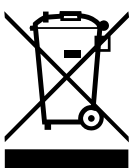

- Zgodnie z dyrektywą WEEE oraz krajową ustawą transponującą jako dystrybutorzy sprzętu elektrycznego jesteśmy zobowiązani do bezpłatnego odbioru niektórych zużytych urządzeń elektrycznych.
- Przy zakupie nowego urządzenia elektrycznego i elektronicznego mogą Państwo bezpłatnie przekazać nam stare urządzenie elektryczne, które zasadniczo spełnia te same funkcje co nowe. Jeżeli Państwa zużyte urządzenie elektryczne nie przekracza 25 centymetrów w dowolnym wymiarze, mogą je Państwo przekazać nam bezpłatnie bez konieczności zakupu nowego urządzenia. Prosimy o kontakt z nami w tej sprawie pod adresem [care@womanizer.com](mailto:care@womanizer.com). Zorganizujemy wtedy zwrot zużytego urządzenia elektrycznego. Ze względów bezpieczeństwa prosimy o nieprzysyłanie sprzętu oświetleniowego (np. lampek). W celu zwrotu sprzętu oświetleniowego prosimy o korzystanie z punktów zbiórki publicznych podmiotów odpowiedzialnych za gospodarkę odpadami lub o bezpośredni kontakt z nami pod wyżej wymienionym adresem e-mail.
- Ponadto zużyte urządzenia elektryczne można oddawać we wszystkich punktach zbiórki podmiotów odpowiedzialnych za gospodarkę odpadami. Przekazując zużyte urządzenia elektryczne do selektywnej zbiórki w odpowiednich grupach, wnoszą Państwo istotny wkład w ponowne wykorzystanie, recykling i inne sposoby odzysku zużytych urządzeń.
- Jako użytkownik końcowy są Państwo odpowiedzialni za usunięcie danych osobowych ze zużytego urządzenia elektrycznego przed oddaniem go do utylizacji.
- Aby zapobiec powstawaniu odpadów, należy przestrzegać wskazówek zawartych w instrukcji obsługi oraz instrukcji bezpieczeństwa, a także sprawdzić możliwości naprawy.



# GENERAL INFORMATION

## ELECTRICAL RATING

**Model:** OG

**Model No.:** TES10A

**Power Input:**

3,7 V=0,62 A: Built-in Li-Polymer rechargeable battery.

5 V=0,5 A: When charged using USB.

Use USB AC adaptor (not included) with power output corresponding to product rating. Use original provided cable only."

## CONTENT OF DELIVERY

Womanizer OG G-Spot vibrator, USB charging cable (AC adapter not included), cotton storage pouch, quick start guide, safety instructions

## ENVIRONMENTAL PROTECTION

As a distributor of electronic devices, we are legally obliged to accept the return of waste electrical and electronic devices free of charge. We expressly state that you as the user are legally obliged to return used batteries.

Never throw away electronic devices or batteries in the household waste. The symbol shown below (crossed-out wheeled bin) is intended to expressly remind you of this.

## MANUFACTURED AND DISTRIBUTED BY

**WOW Tech Europe GmbH**

Hermann-Blankenstein-Strasse 5

10249 Berlin

[www.wowtech.com](http://www.wowtech.com)

WOW Tech Europe GmbH reserves the right to make technical changes and changes to the design that serve to improve the device.

For information regarding patents see [womanizer.com/patents](http://womanizer.com/patents).

## CUSTOMER CARE

[care@womanizer.com](mailto:care@womanizer.com)

[womanizer.com](http://womanizer.com)

Designed in Germany. Made in China.

Date of issue: 10/2022.



# WCIĄŻ PRAGNIESZ WIĘCEJ?

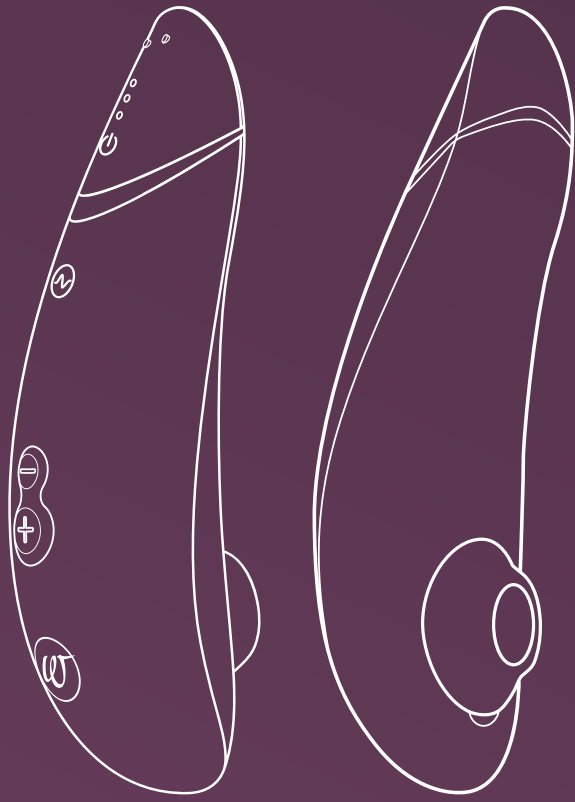

Pleasure Air  
Technology™

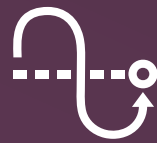

Autopilot



Smart Silence

**Premium 2**  
Define your luxury

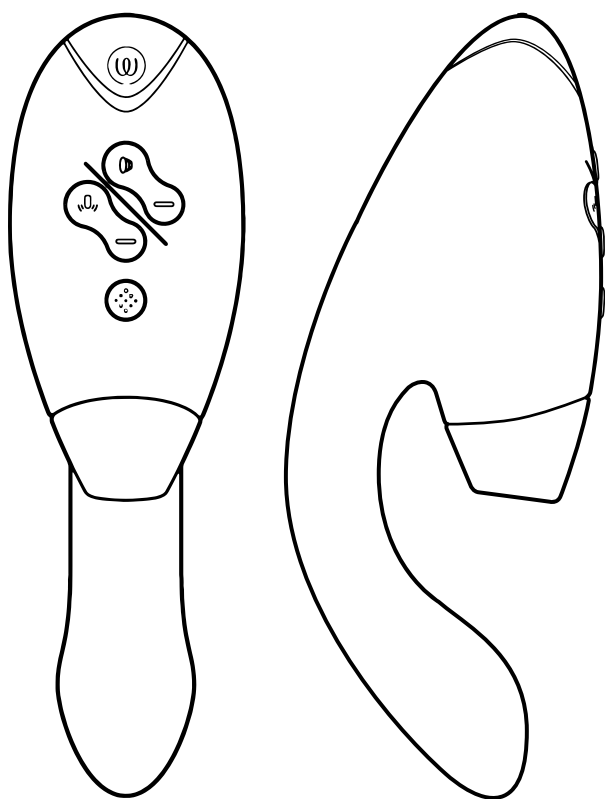

Pleasure Air  
Technology



Double Stimulation



Smart Silence

**Duo 2**  
Indulge in whole-body orgasms



#IMASTURBATE

# Hi!

Tack för att du valt **WOMANIZER OG**.

Välkommen till en värld full av sensuella upplevelser som kommer att berika ditt liv. Genom att välja **WOMANIZER** får du inte bara garanterade orgasmer som är olika allt du tidigare upplevt – du kan också utforska en helt ny lust för njutning.

Njut av din **WOMANIZER OG** - en orgasm i taget.

Sätt igång, älska dig själv!



**BESKRIVNING**

**ANVÄNDNINGSSINSTRUKTIONER**

**SMART SILENCE**

**RENGÖRING**

**LADDNING**

**SAFETY INSTRUCTIONS**

**ALLMÄN INFORMATION**

Please read the safety instructions in the  
Compliance & Safety Information before first use.

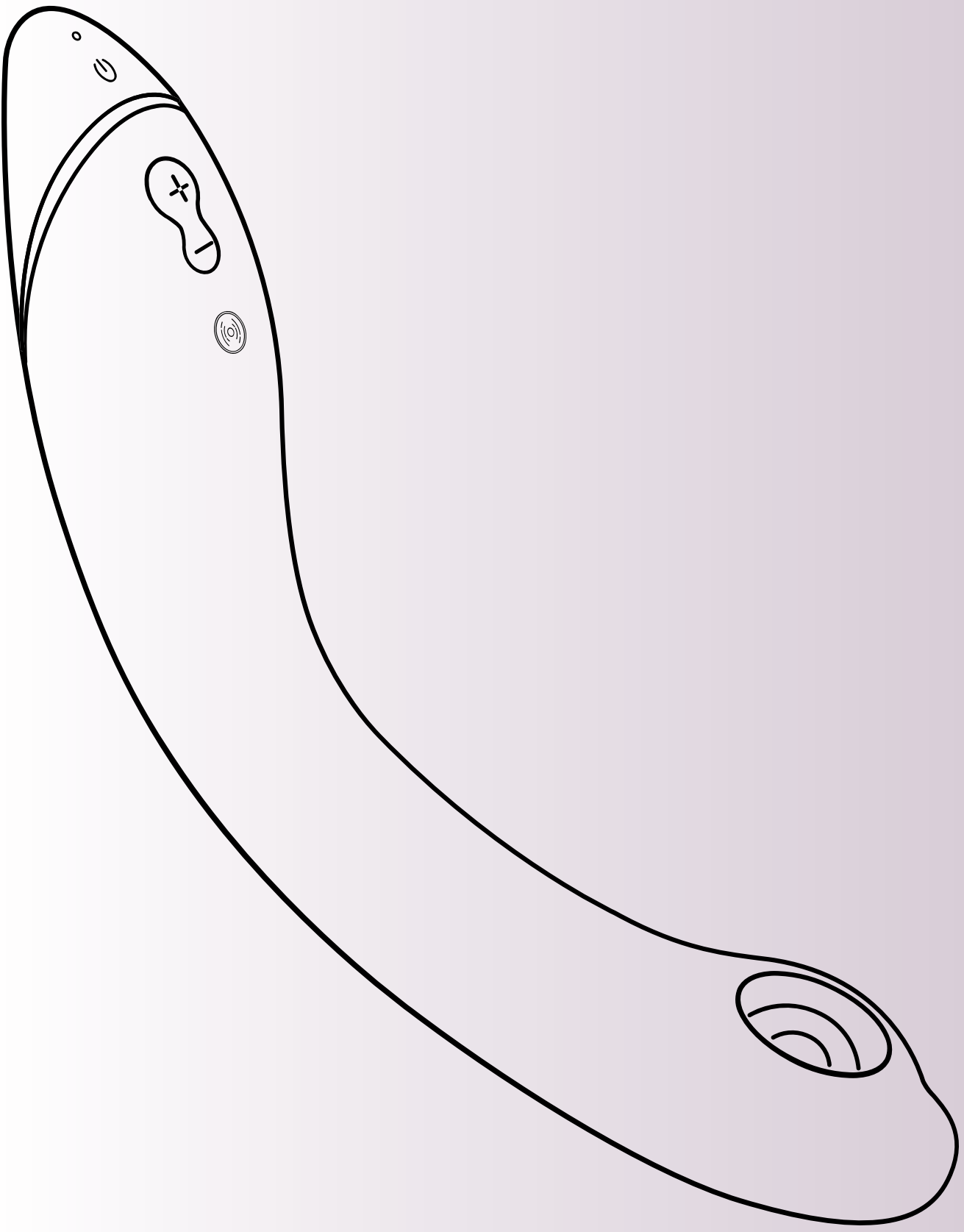

# BESKRIVNING

**LED-display**  
På/Laddning

**Smart Silence**  
På/Av  
Tryck i 2 sekunder

**Vibration**  
Tryck kort för  
att aktivera och  
öka intensitet  
(3 nivåer)

**Pleasure Air Technology**  
(12 nivåer)

**På/Av**  
Tryck i 2 sekunder

**Öka intensitet**  
Tryck kort på (+)

**Minska intensitet**  
Tryck kort på (-)

**Afterglow**  
Tryck på (-) i 1 sekund



# ANVÄNDNINGSSINSTRUKTIONER

## 1. Starta

Tryck i 2 sekunder.  
Lysdioden visar att  
produkten är påslagen.

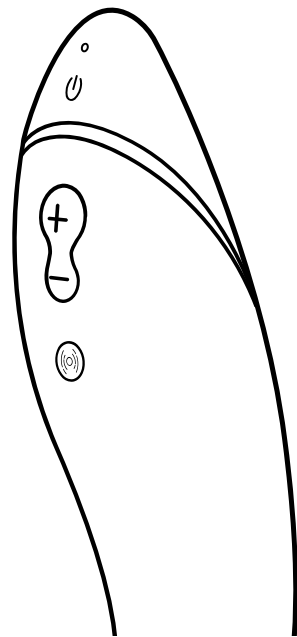

## 2. Användning

För att komma igång  
använder du **OG** på din  
klitoris först.

Applicera vattenbaserat  
glidmedel på **OG**:s kropp.

När du har värmt upp för du  
in **OG** och utforskar din G-punkt!

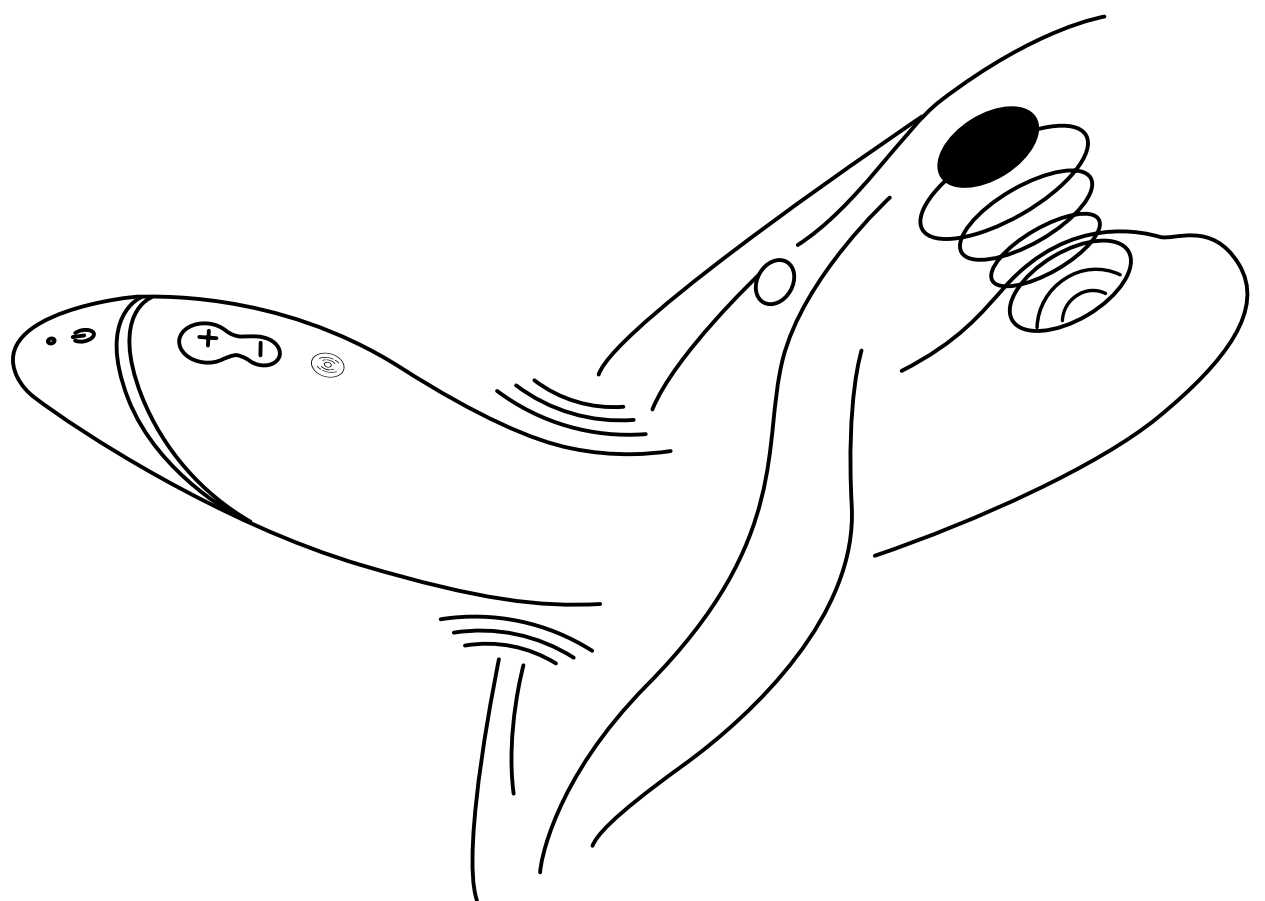
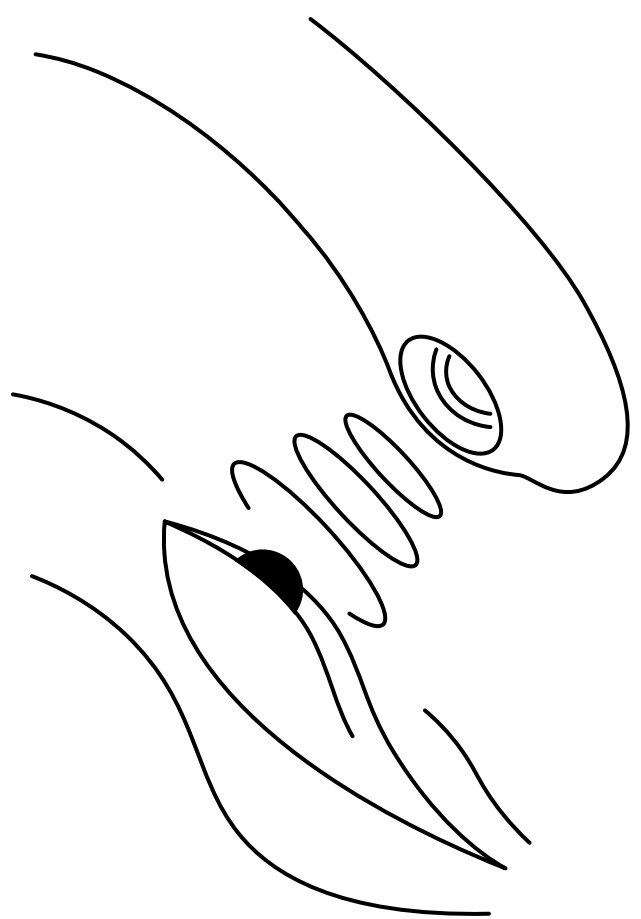



# ANVÄNDNINGSSINSTRUKTIONER

## 3. Ändra intensitet

**Öka** —————  
Tryck kort  
**12 intensitetsnivåer**

**Öka** —————  
Tryck kort  
**3 vibrationsnivåer**

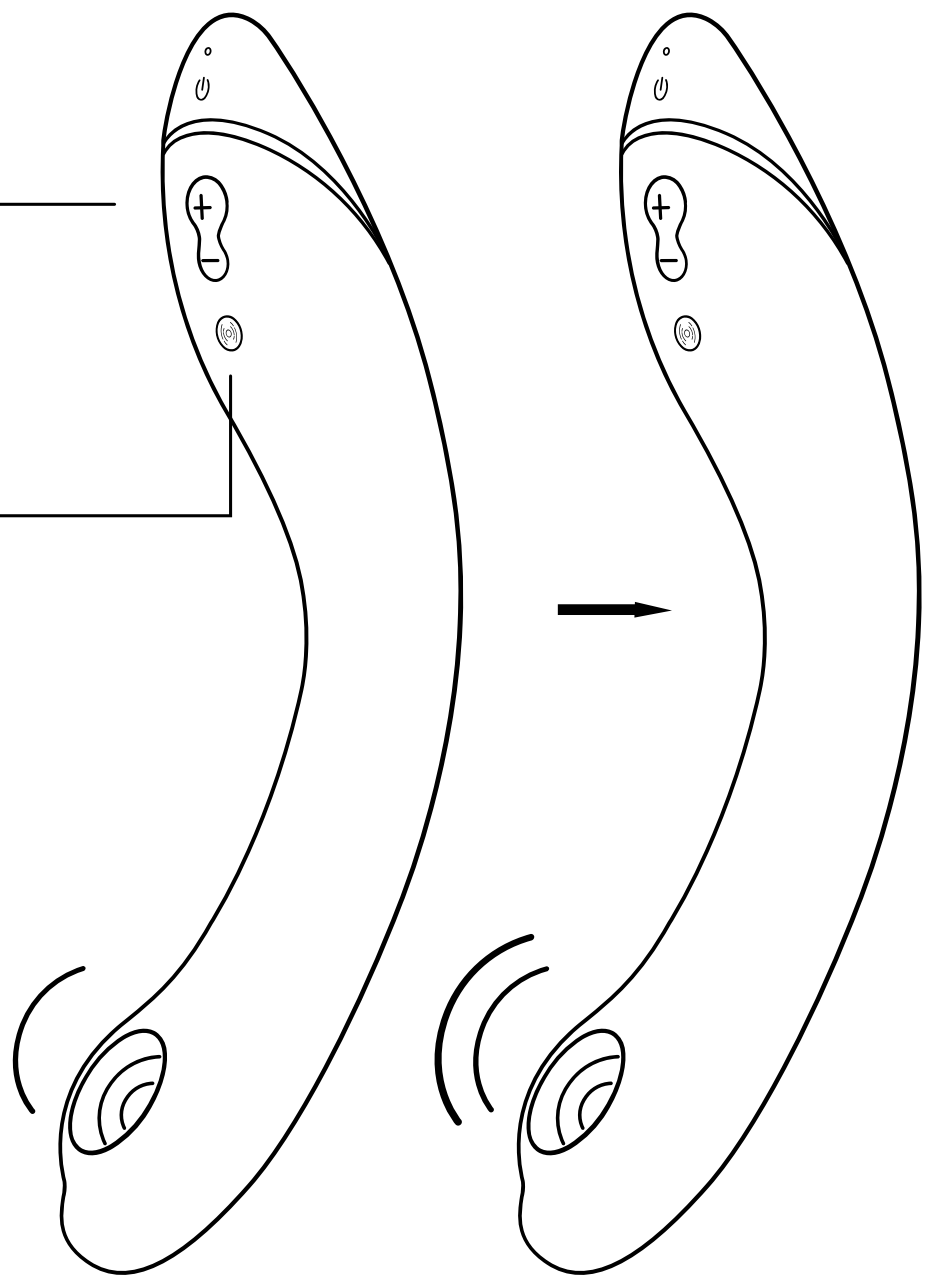

**Minska** —————  
Tryck kort

**Afterglow**  
Tryck på (-) i 1 sekund  
för att återgå till  
intensitetsnivå 1

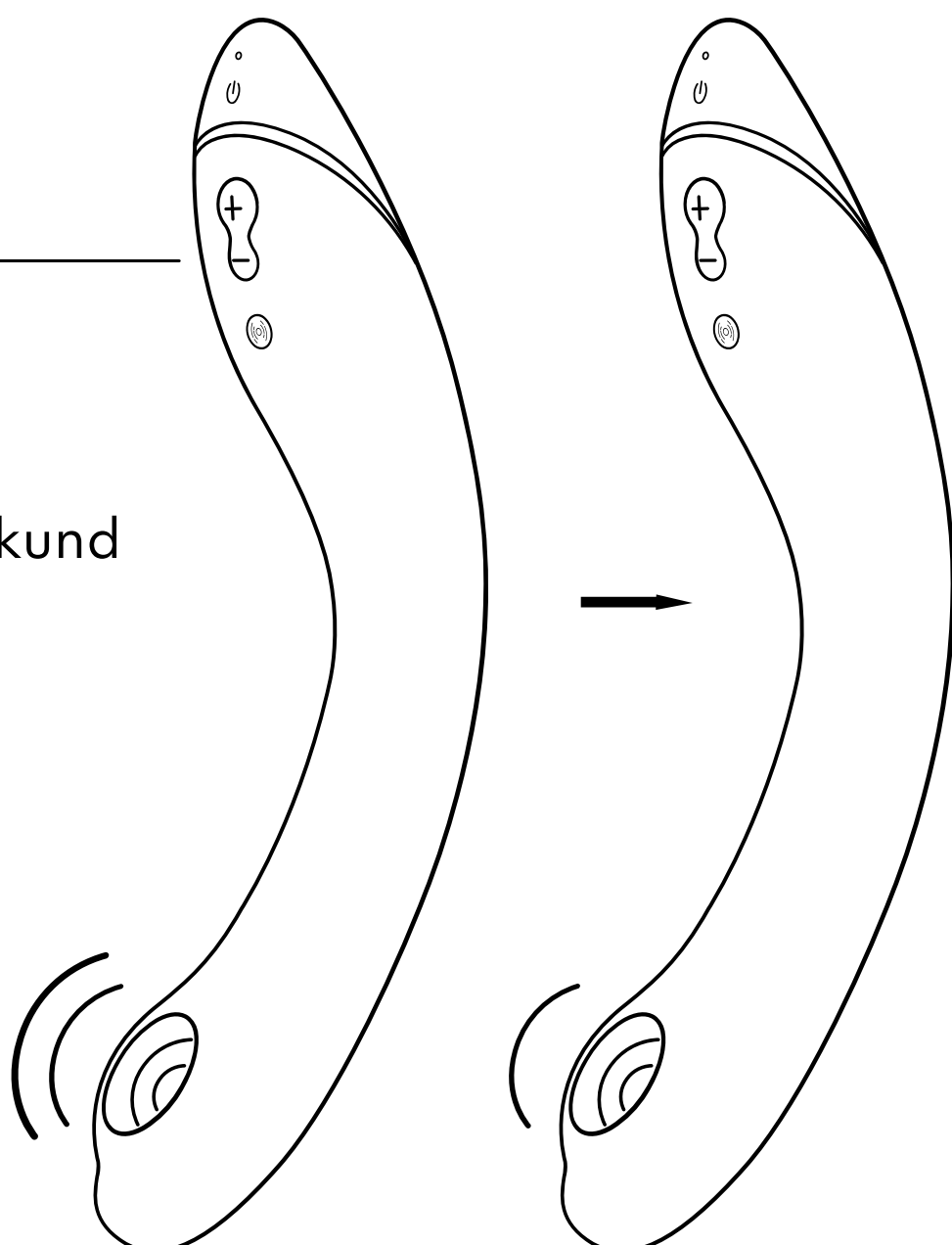

# ANVÄNDNINGSSINSTRUKTIONER

4. **Stäng av** —————  
Tryck i 2 sekunder

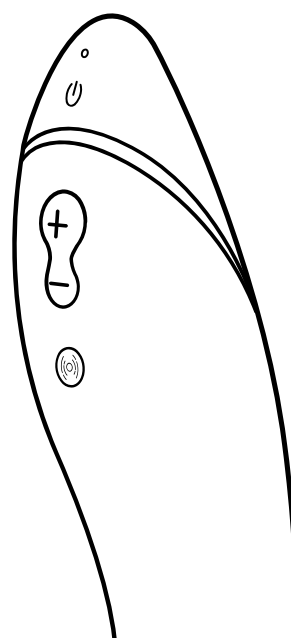

## SMART SILENCE

**OG** slås bara på när den nästan rör din hud. Smart Silence slås på som standard. Tryck och håll inne plus- och minusknapparna i 2 sekunder för att slå på eller stänga av Smart Silence.

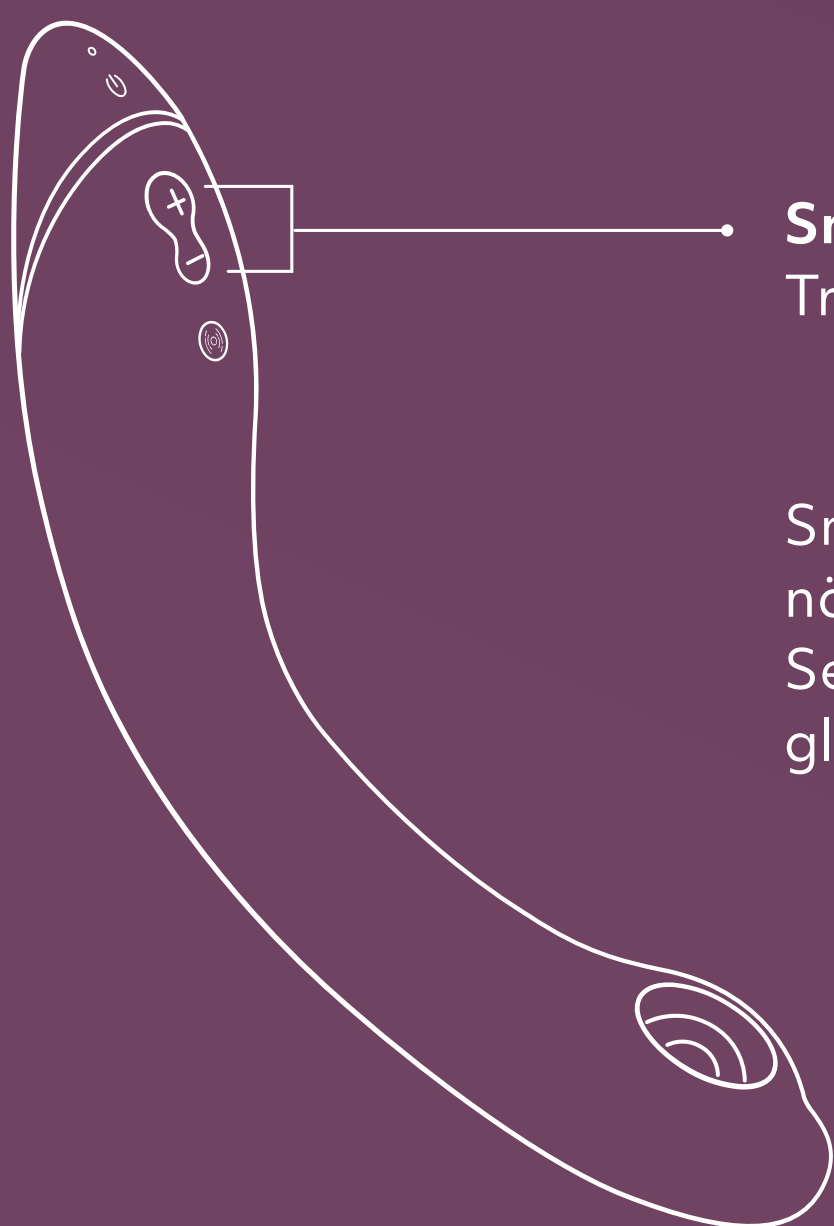

**Smart Silence På/Av**  
Tryck i 2 sekunder

Smart Silence kanske inte fungerar när stimuleringshuvudet är blött. Se därför till att inte applicera glidmedel på Pleasure Air-huvudet.

# RENGÖRING

Tvätta under vatten.

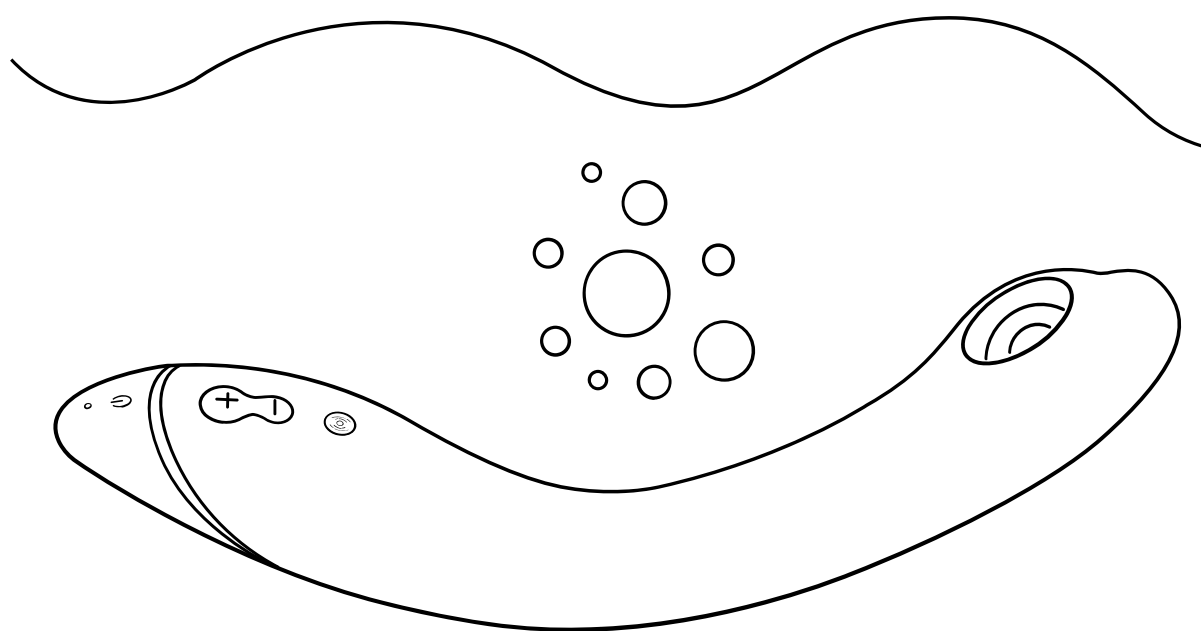

Applicera rengöringsmedel för leksaker.

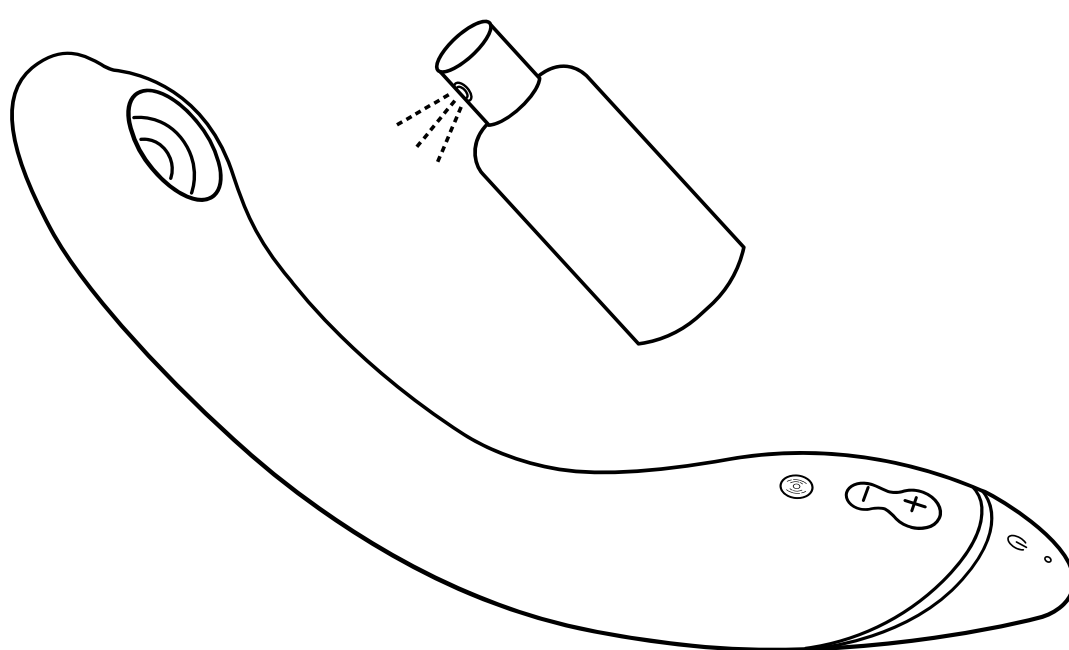

Torka noggrant utan att trycka för hårt på membranet.

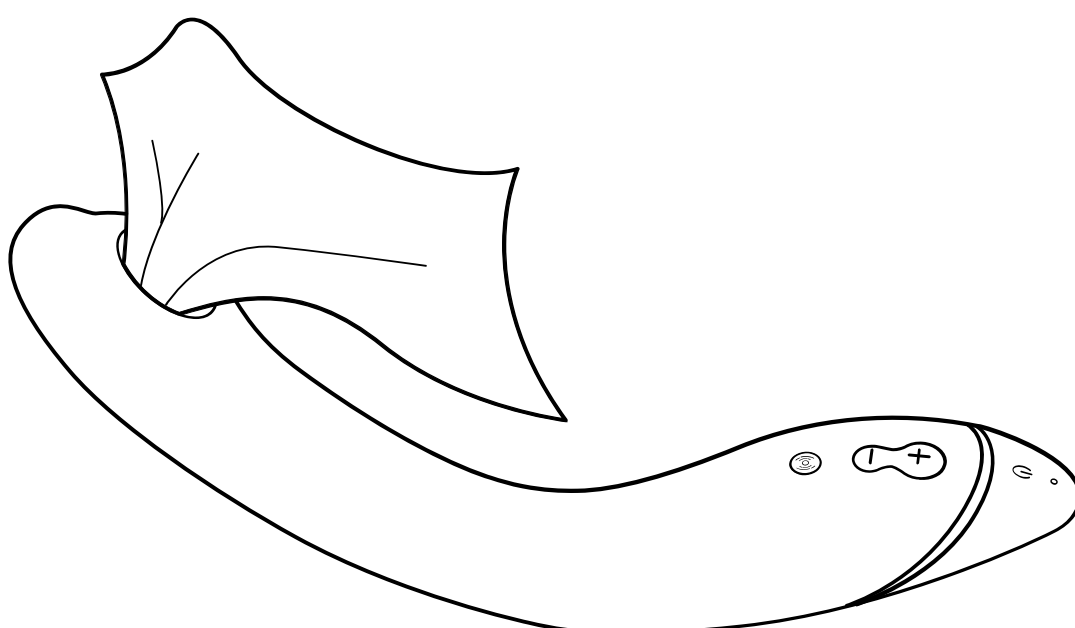

Vattentät  
(IPX7)

# LADDNING

Ladda din **OG** före första användningen. Tänk också på att ladda din **OG** regelbundet för att säkerställa ett långt batteriliv.

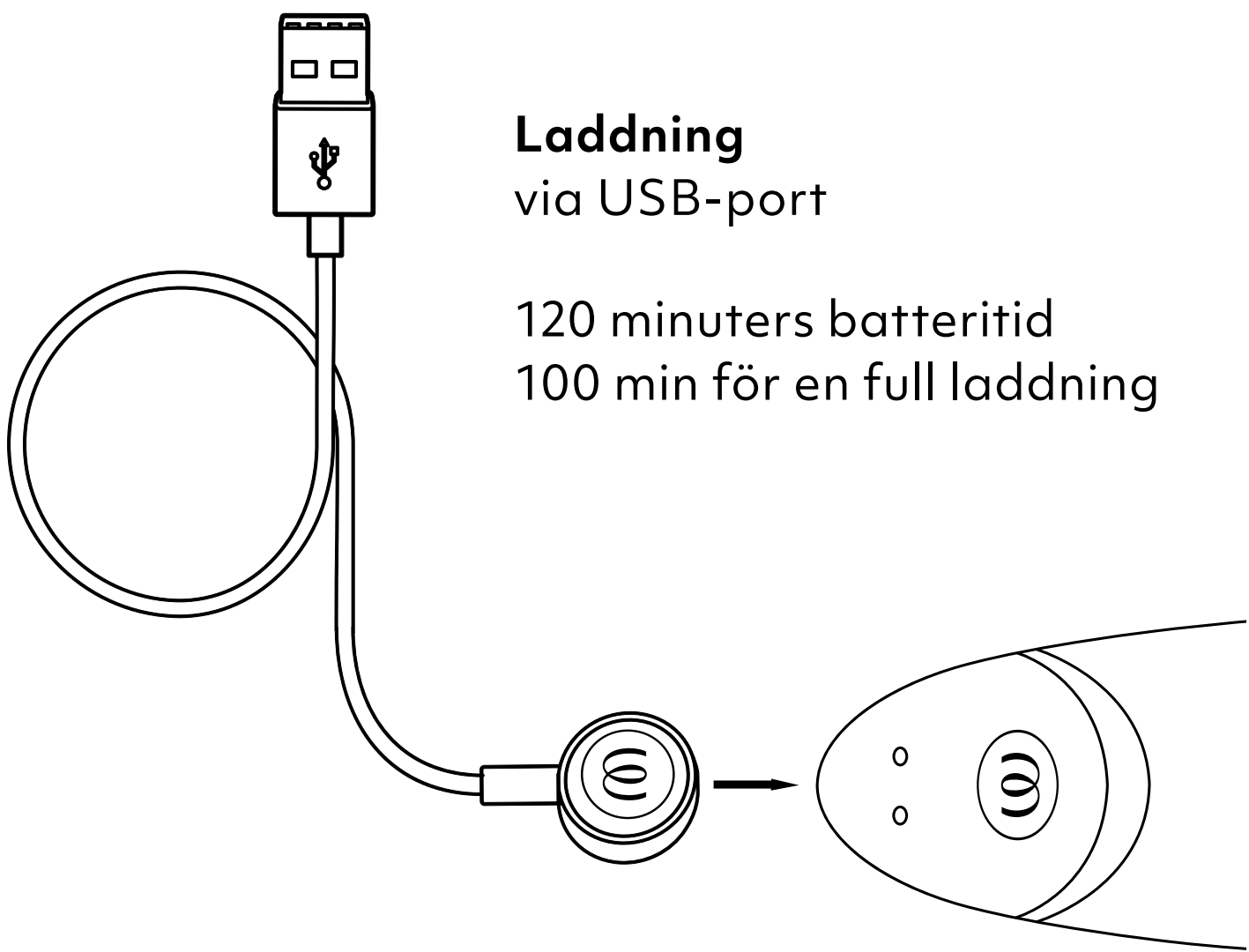

**Laddning**  
via USB-port

120 minuters batteritid  
100 min för en full laddning

---

**Lysdiod**  
På/Av/Laddning

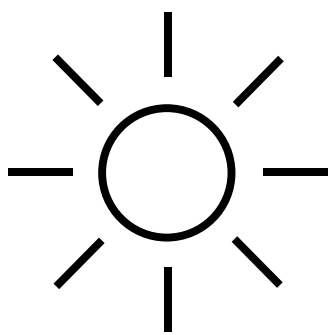

**Fulladdad**  
Lysdioden lyser kontinuerligt

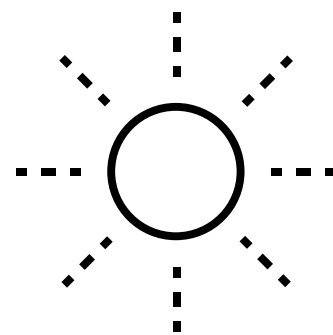

**Laddning**  
Lysdioden blinkar

# SAFETY INSTRUCTIONS

## WARNING

Endast avsedd som nöjesprodukt. Produkten ska endast användas för avsett ändamål. Förvara produkten utom räckhåll för barn. Olämplig för medicinska ändamål. Om du är under läkarvård eller har ett tillstånd som kräver användning av medicinsk utrustning, kontakta då din läkare innan du använder den här produkten. Sluta använda produkten omedelbart om du får hudirritationer, smärta eller obehag och rådfråga din läkare.

Denna produkt kan användas av vuxna och av personer med nedsatt fysisk, sensorisk eller mental förmåga samt av personer som saknar erfarenhet och kunskap om produkten, under förutsättning att de har instruerats i hur produkten används på ett säkert sätt och förstår vilka faror som kan uppstå. Barn får inte leka med produkten. Barn får inte rengöra eller utföra underhåll av produkten. Använd inte på svullen eller inflammerad hud.

- Ta bort piercingar och smycken i könsorganet före användning.
- Rengör alltid produkten före och efter användning i enlighet med instruktionerna i bruksanvisningen.
- För att undvika skador på produkten får produkten och dess batteri inte utsättas för temperaturer över 45 °C, monteras isär eller utsättas för mekaniska eller elektriska skador.
- Om man delar sina sexleksaker med andra personer finns risk för överföring av könssjukdomar. Dela inte dina sexleksaker med några andra personer än din partner. Använd skydd även med din partner om detta är nödvändigt. Använd inte leksaken om det finns sprickor eller tecken på slitage på ytterhöljet.
- Produkten är inte avsedd för anal användning. Använd inte produkten analt!
- Placera inte produktens mjuka sida på absorberande underlag för att undvika fläckar.
- Kontrollera regelbundet laddaren och apparaten efter skador. Använd inte apparaten om någon komponent är skadad.
- Magnetfält kan påverka mekaniska och elektroniska komponenter som pacemakers. Använd inte enheten direkt över pacemakern. Kontakta din läkare för mer information. För inte kort med magnetband (t.ex. kreditkort) nära enheten, eftersom de kan skadas av magneterna på produkten.
- Om apparaten inte fungerar som den brukar ska du stänga av den och vända dig till supporten på vår hemsida.

## LADDR

- Innan du använder laddaren ska du kontrollera den lokala spänningsnivån eftersom den lokala nätspänningen inte får överskrida den högsta tillåtna nätspänningen som anges på laddaren.
- Produkten får endast försörjas med extra låg säkerhetsspänning som överensstämmer med märkningen på produkten.
- Använd inte eller rengör produkten medan batteriet laddas.
- Doppa aldrig ned laddaren eller laddningskabeln i vatten eller andra vätskor.
- Denna produkt innehåller ej utbytbara batterier.
- Denna produkt innehåller ett uppladdningsbart litiumjonbatteri.
- Dra ut laddkabeln från vägguttaget efter varje laddning.

## FÖLJ FÖLJANDE RIKTLINJER FÖR BÄSTA ANVÄNDNING AV PRODUKTEN:

- För att batteriet ska hålla länge är det viktigt att ladda det regelbundet, även om det inte används.
- Förvara på en säker, torr plats utan direkt solljus.
- Vi rekommenderar att du använder vattenlösligt glidmedel till din apparat. Använd inte parfymerade, silikon- eller alkoholbaserade glidmedel, gels eller massageoljor eftersom det kan skada apparaten.

# GENERAL INFORMATION

## ELECTRICAL RATING

**Model:** OG

**Model No.:** TES10A

**Power Input:**

3,7 V=0,62 A: Built-in Li-Polymer rechargeable battery.

5 V=0,5 A: When charged using USB.

Use USB AC adaptor (not included) with power output corresponding to product rating. Use original provided cable only."

## CONTENT OF DELIVERY

Womanizer OG G-Spot vibrator, USB charging cable (AC adapter not included), cotton storage pouch, quick start guide, safety instructions

## ENVIRONMENTAL PROTECTION

As a distributor of electronic devices, we are legally obliged to accept the return of waste electrical and electronic devices free of charge. We expressly state that you as the user are legally obliged to return used batteries.

Never throw away electronic devices or batteries in the household waste. The symbol shown below (crossed-out wheeled bin) is intended to expressly remind you of this.

## MANUFACTURED AND DISTRIBUTED BY

**WOW Tech Europe GmbH**

Hermann-Blankenstein-Strasse 5

10249 Berlin

[www.wowtech.com](http://www.wowtech.com)

WOW Tech Europe GmbH reserves the right to make technical changes and changes to the design that serve to improve the device.

For information regarding patents see [womanizer.com/patents](http://womanizer.com/patents).

## CUSTOMER CARE

[care@womanizer.com](mailto:care@womanizer.com)

[womanizer.com](http://womanizer.com)

Designed in Germany. Made in China.

Date of issue: 10/2022.



# VILL DU HAMER?



Pleasure Air  
Technology

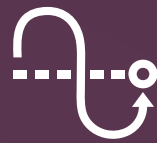

Autopilot



Smart Silence

**Premium 2**  
Define your luxury

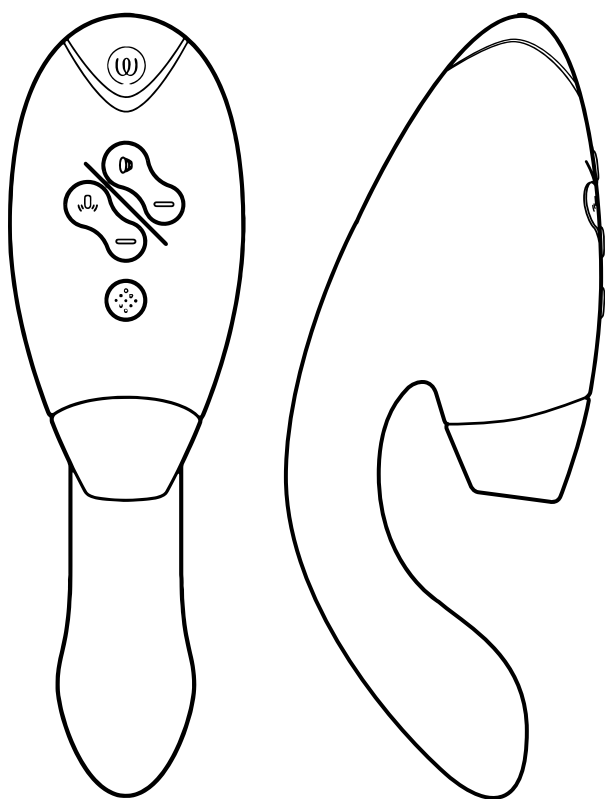

Pleasure Air  
Technology



Double Stimulation



Smart Silence

**DUO 2**  
Indulge in whole-body orgasms



#IMASTURBATE



# Hi!

Obrigado por escolher o **WOMANIZER OG**.

Bem-vinda a um mundo cheio de experiências sensuais que irão enriquecer a sua vida. Ao escolher o **WOMANIZER**, não estará apenas a garantir orgasmos como nunca sentiu mas também um novo desejo por prazer.

Desfrute do seu **WOMANIZER**, um orgasmo após o outro.

Vá, ame-se!



DESCRIÇÃO

COMO USAR

SMART SILENCE

LIMPEZA

CARREGAMENTO

SAFETY INSTRUCTIONS

INFORMAÇÕES GERAIS

Please read the safety instructions in the  
Compliance & Safety Information before first use.

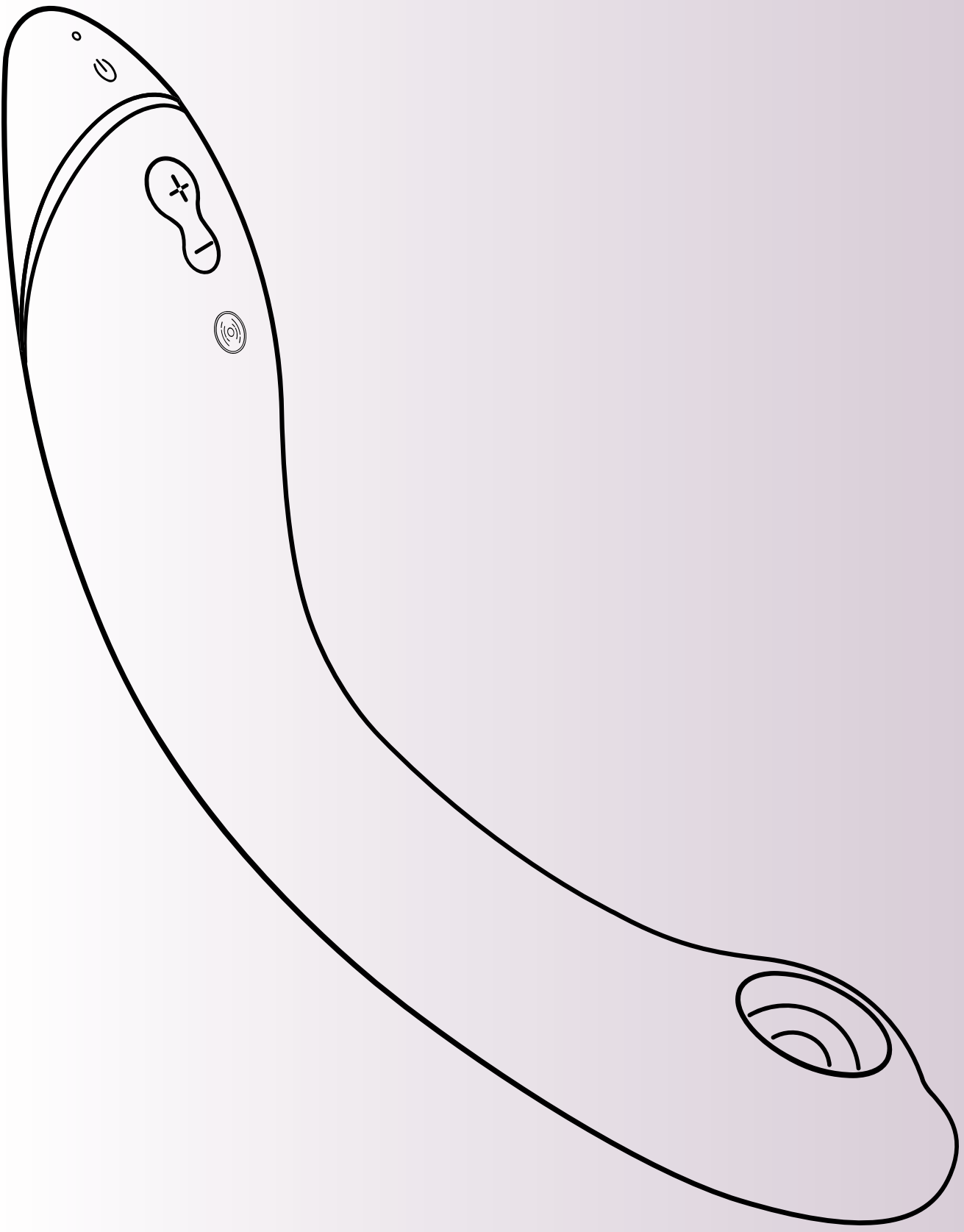

# DESCRIÇÃO

## Indicador LED

Ligado/A carregar

## Ligar/Desligar Smart Silence

Pressionar por 2 segundos

## Vibração

Pressionar brevemente para ativar e aumentar a intensidade (3 níveis)

## Pleasure Air Technology (12 níveis)

## Ligar/Desligar

Pressionar por 2 segundos

## Aumentar a intensidade

Pressionar (+) brevemente

## Diminuir a intensidade

Pressionar (-) brevemente

## Brilho

Pressionar (-) por 1 segundo



# COMO USAR

## 1. Ligar

Pressionar por 2 segundos  
O LED irá indicar que o  
brinquedo está ligado.

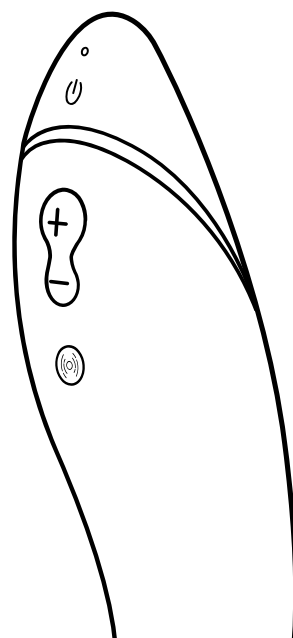

## 2. Uso

Para se ambientar,  
use primeiro o **OG** no  
seu clítoris.

Aplique lubrificante à base  
de água no corpo do **OG**.

Feito o aquecimento, insira  
o **OG** e explore o seu ponto G!

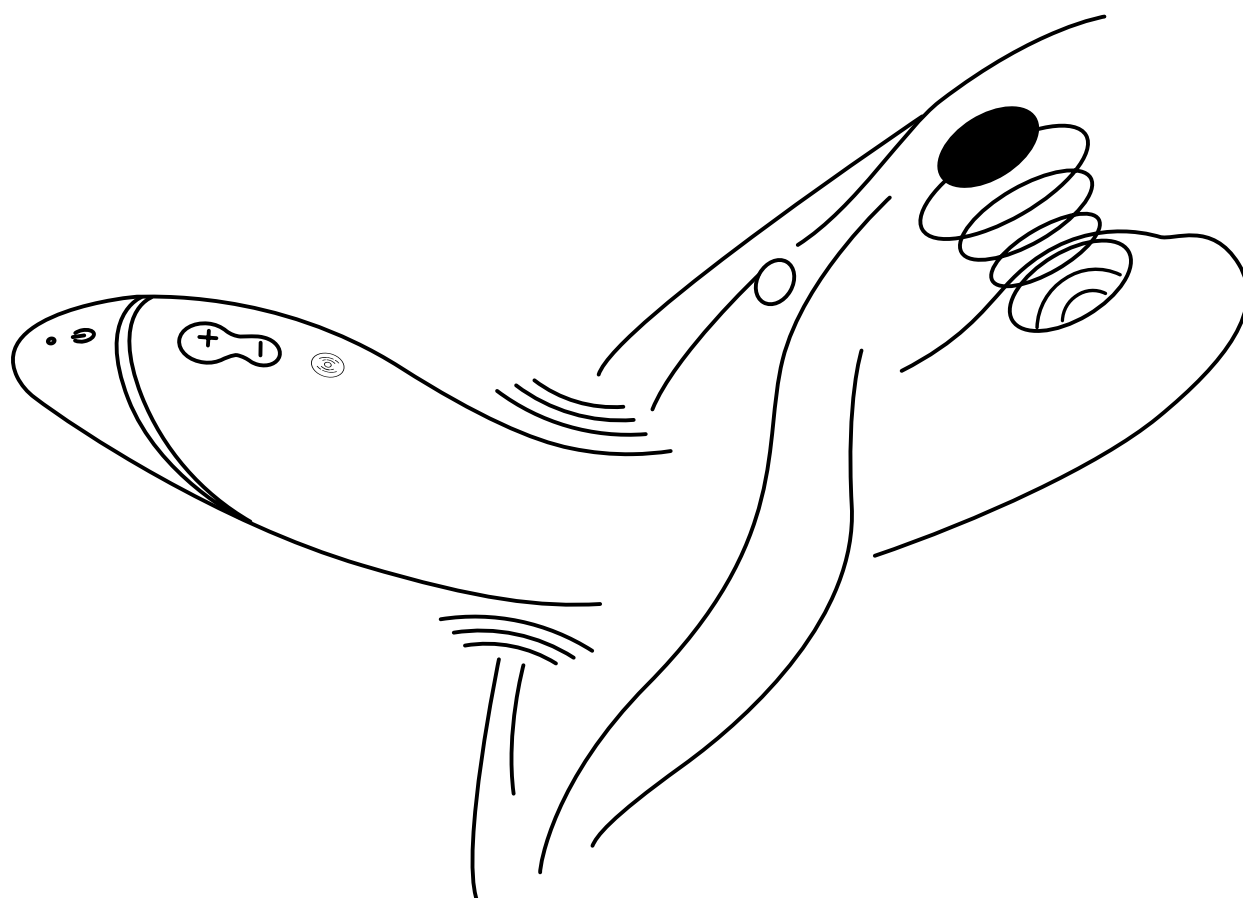
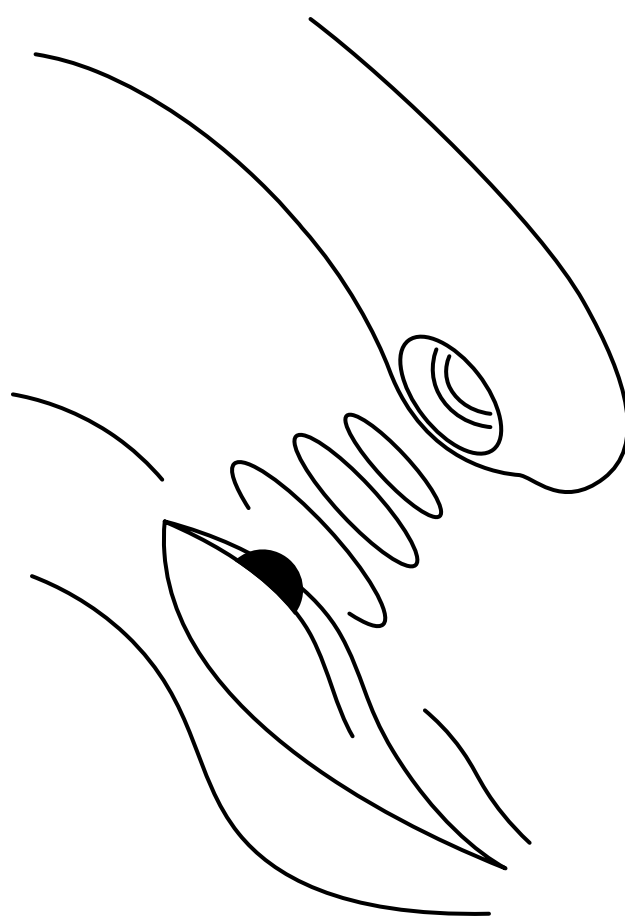

# COMO USAR

## 3. Alterar a intensidade

**Aumentar**

Pressionar brevemente  
**12 Níveis de Intensidade**

**Aumentar**

Pressionar brevemente  
**3 Níveis de Vibração**

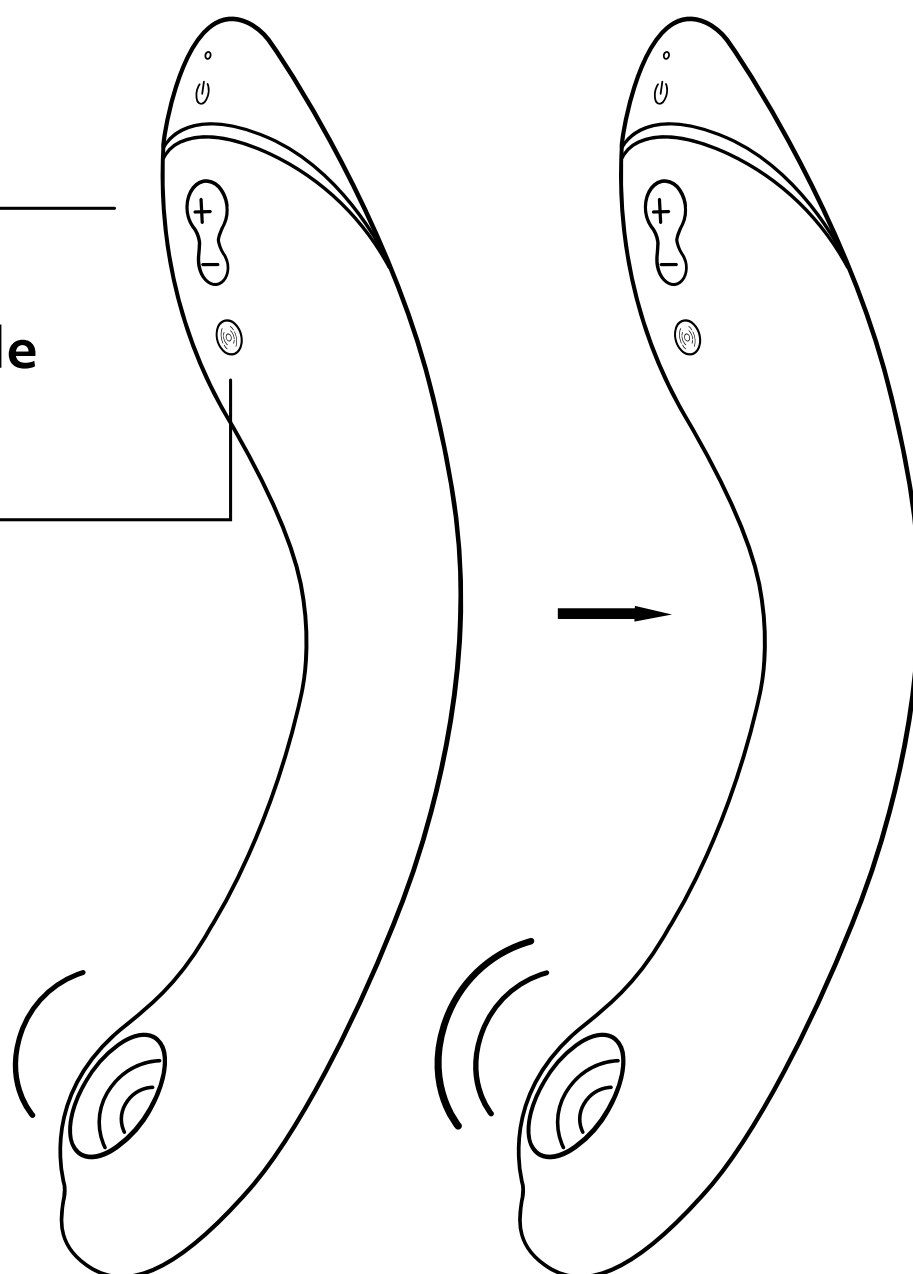

**Diminuir**

Pressionar brevemente

**Brilho**

Pressionar (-) por 1  
segundo para voltar ao  
Nível de Intensidade 1

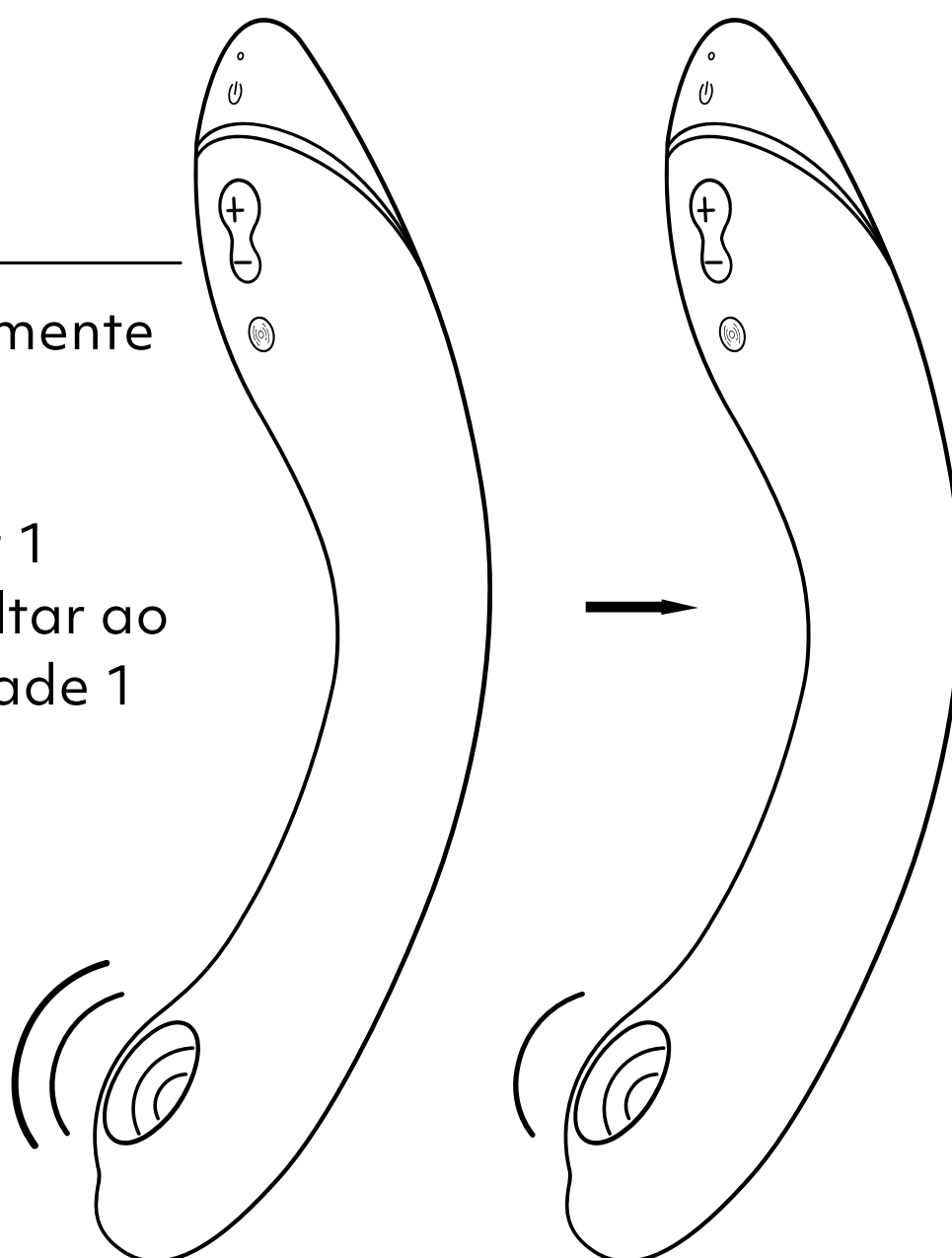

# COMO USAR

4. **Desligar** —————  
Pressionar por 2 segundos

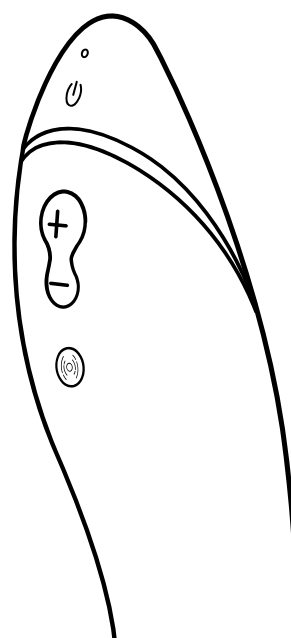

## SMART SILENCE

O **OG** só se liga quando está quase a tocar a sua pele. O modo Smart Silence liga-se por predefinição. Pressione os botões de mais e menos por 2 segundos para ligar e desligar o Smart Silence.



**Smart Silence Ligar/Desligar**  
Pressionar por 2 segundos

O Smart Silence pode não funcionar quando a cabeça estimulante está molhada. Por isso, por favor certifique-se que não aplica lubrificante na ponta do Pleasure Air.

# LIMPEZA

Limpar com água corrente.

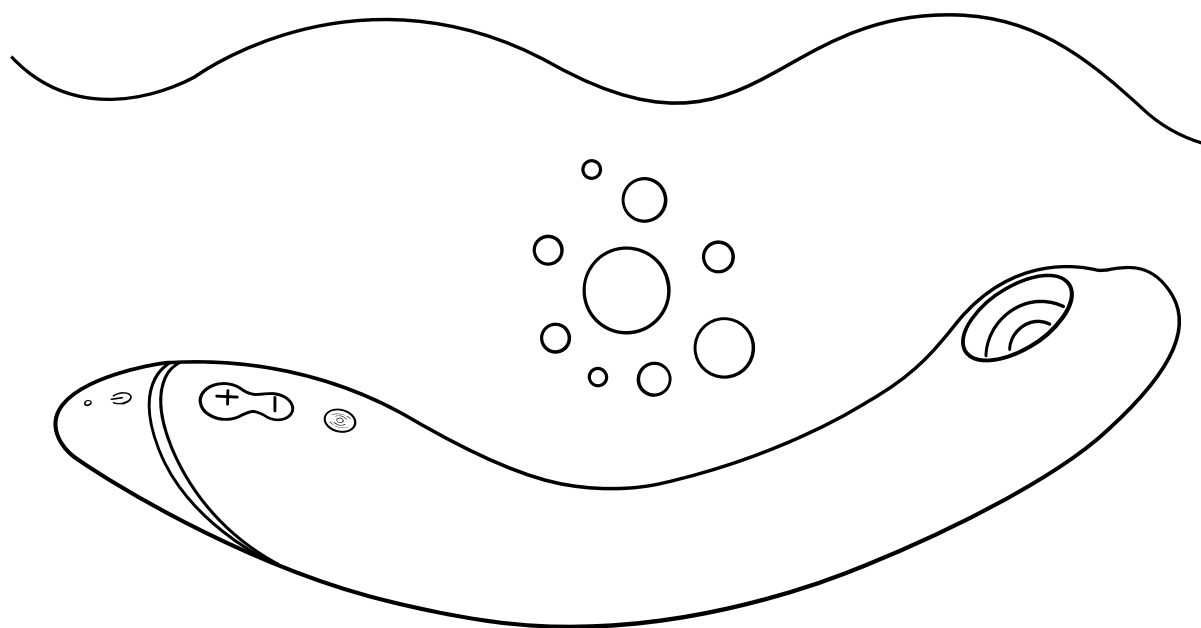

Usar um produto próprio para limpeza de brinquedos.

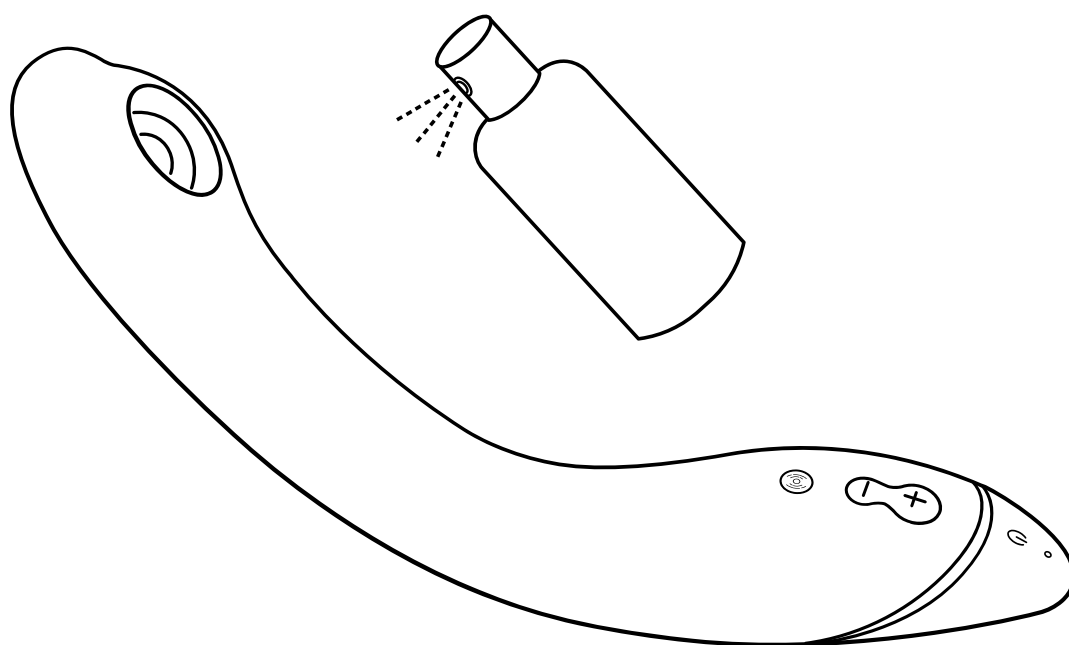

Secar cuidadosamente sem aplicar muita pressão na membrana.

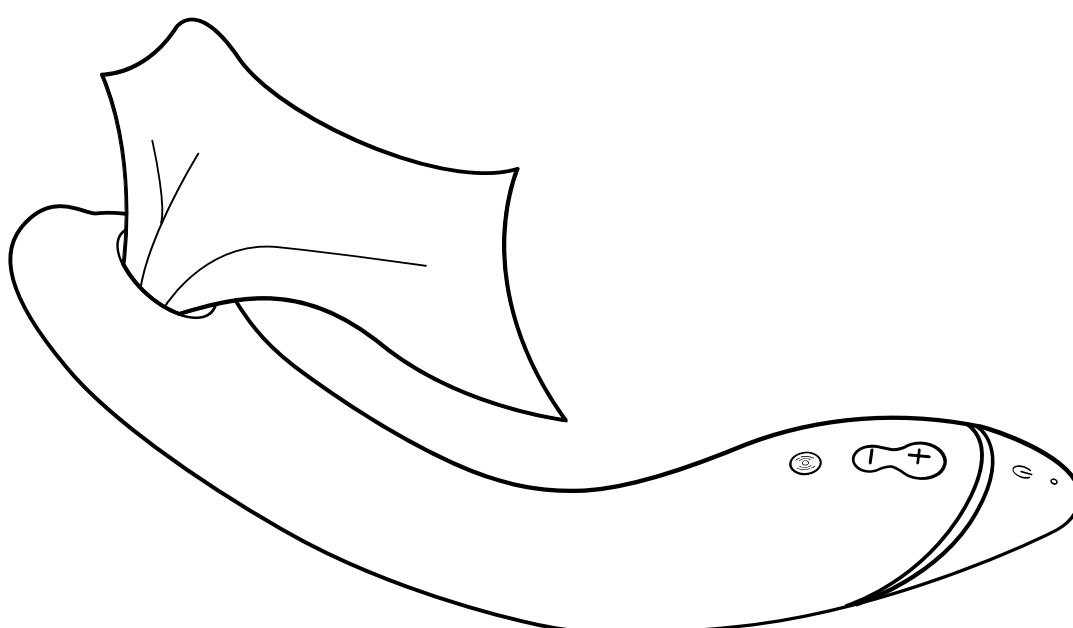

À prova de água  
(IPX7)



# CARREGAMENTO

Por favor carregue o seu **OG** antes da primeira utilização.  
Lembre-se também de o carregar regularmente para maximizar o tempo de vida útil da bateria.

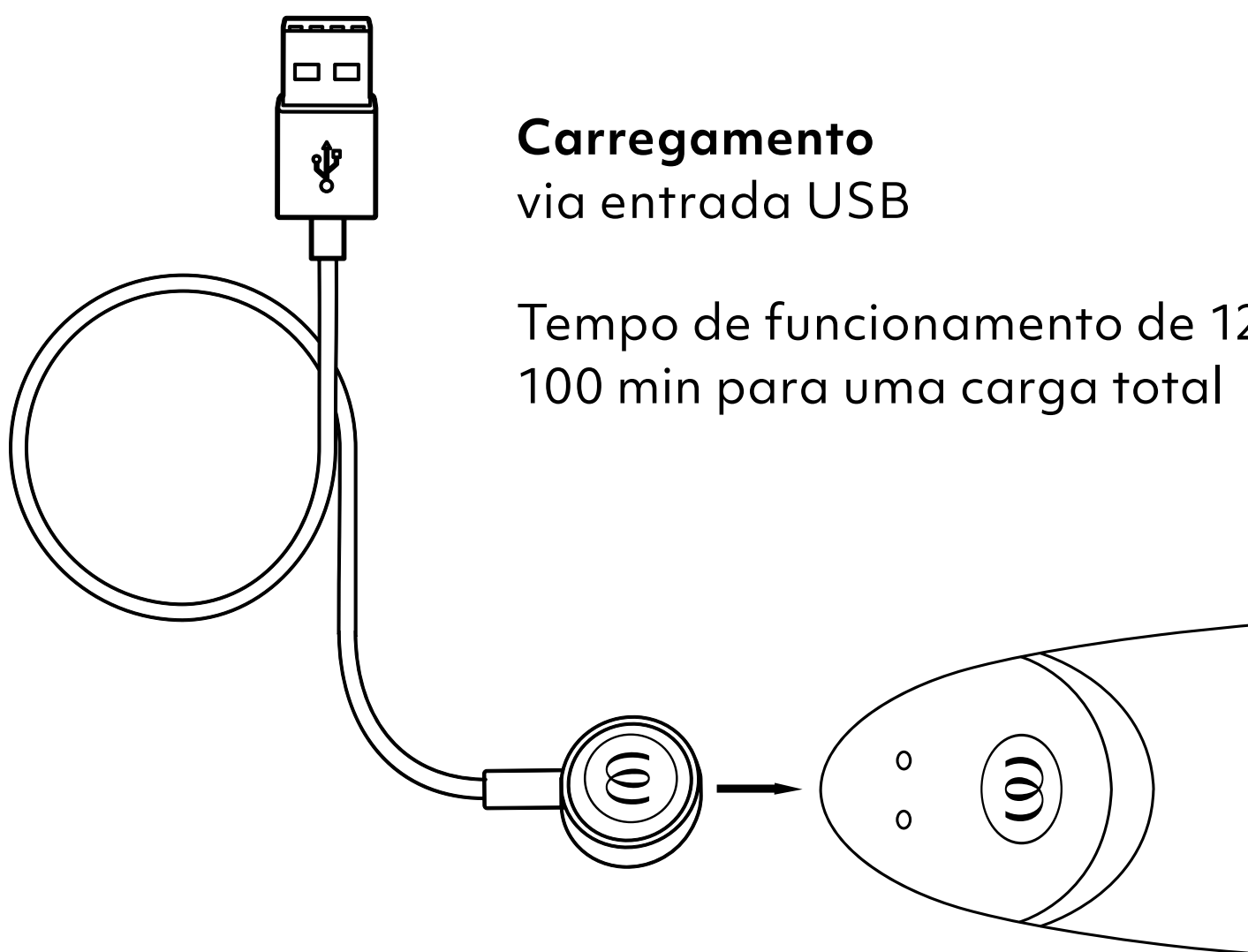

**Carregamento**  
via entrada USB

Tempo de funcionamento de 120 min  
100 min para uma carga total

---

## LED

Ligado/Desligado/A carregar

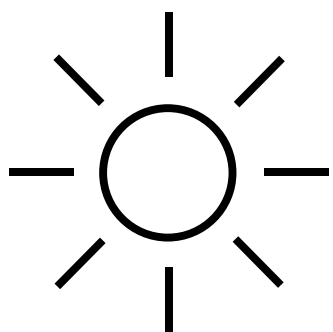

**Totalmente carregado**  
LED acende-se  
continuamente

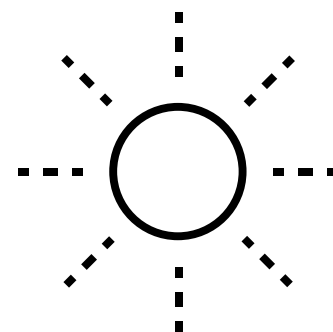

**Carregamento**  
LED pisca

# LIMPEZA

Limpar com água corrente.

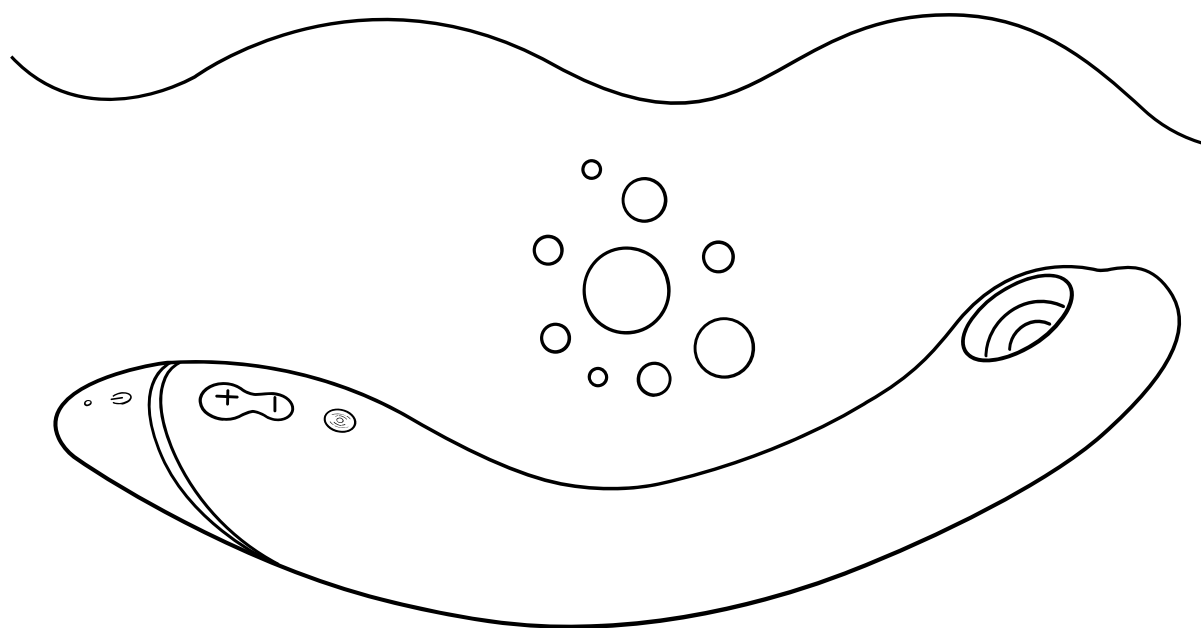

Usar um produto próprio para limpeza de brinquedos.

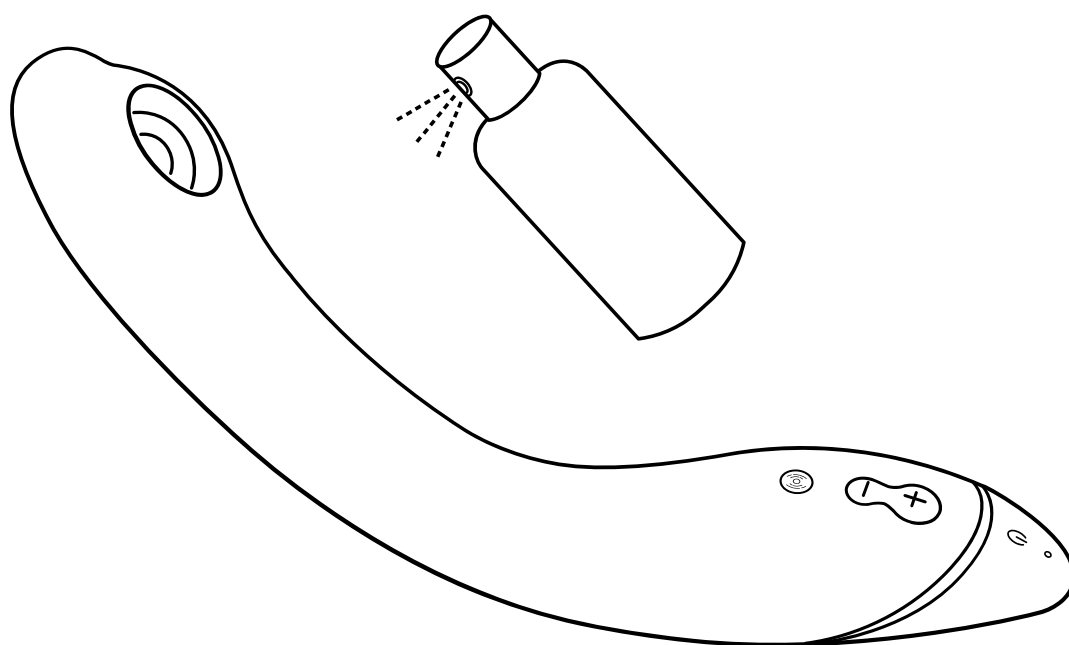

Secar cuidadosamente sem aplicar muita pressão na membrana.

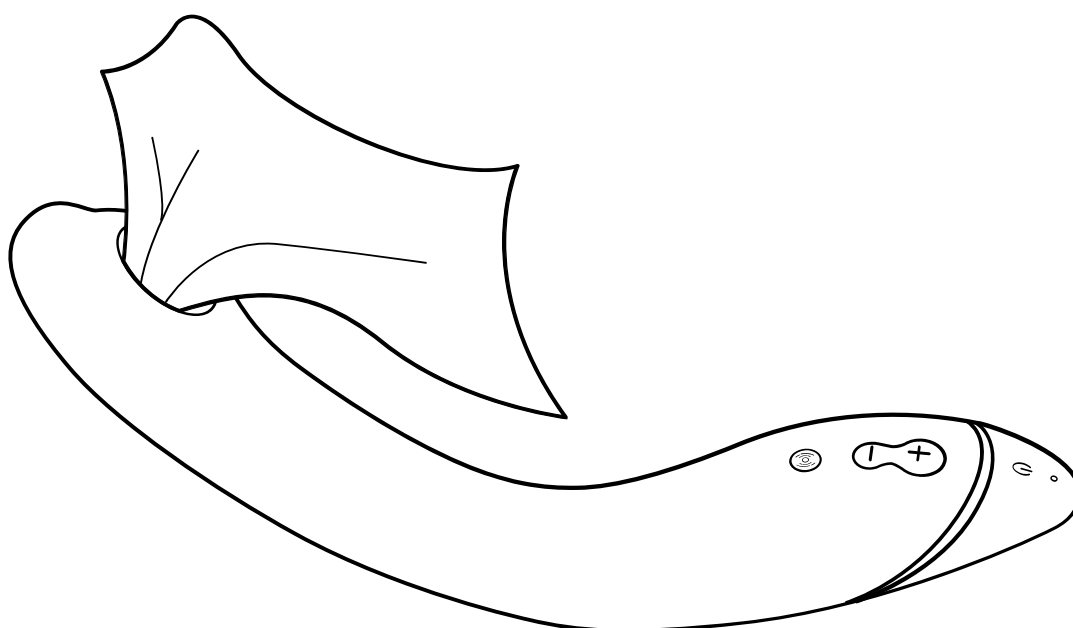

À prova de água  
(IPX7)

# SAFETY INSTRUCTIONS

## AVISO

Vendido apenas como produto novo. Utiliza o produto apenas para o fim previsto. Mantém o produto fora do alcance de crianças. Não adequado para fins médicos. Se estás sob os cuidados de um médico e/ou tens uma doença que requer a utilização de qualquer dispositivo médico, consulta o teu médico antes de utilizares este produto. Para imediatamente de utilizar o produto se sentires qualquer irritação cutânea, dor ou desconforto e consulta o teu médico.

Este dispositivo apenas pode ser utilizado por adultos e pessoas com capacidades físicas, sensoriais ou mentais reduzidas ou com falta de experiência e conhecimentos caso tenham supervisão ou lhes tenham sido fornecidas instruções relativas à utilização do dispositivo em segurança e compreendam os perigos envolvidos. Crianças não devem brincar com o dispositivo. A limpeza e a manutenção por parte do utilizador não devem ser feitas por crianças. Não utilizar em zonas inchadas ou inflamadas da pele.

- Remove os piercings ou joias da área genital antes de usar.
- Limpa sempre o produto antes e depois da utilização, segundo as instruções do manual.
- De forma a evitares danos no produto, nem o produto nem a sua bateria devem ser expostos a temperaturas superiores a 45°C, não devem ser desmontados nem danificados mecânica ou eletricamente.
- A partilha de brinquedos eróticos pode transmitir doenças sexuais. Não partilhes os teus brinquedos eróticos com outras pessoas a não ser com o teu parceiro. Se necessário, usa medidas de proteção com o teu parceiro. Não utilizes o brinquedo se detetares quaisquer fissuras ou sinais de degradação no material do revestimento.
- Este produto não foi concebido para o uso anal. Não usar analmente!
- Para evitar manchas, não coloques o lado macio do teu produto sobre uma superfície absorvente.
- Verifica regularmente se o dispositivo de carga e o aparelho estão danificados e não utilizes o aparelho se algum dos seus componentes estiver danificado.
- Campos magnéticos podem influenciar componentes mecânicos e eletrónicos, como por exemplo, pacemakers. Não uses o produto diretamente sobre o pacemaker. Contacta o teu médico para mais informações. Não coloques cartões com bandas magnéticas (como cartões de crédito) perto do produto, pois podem ser danificados pelo imã no produto.
- Se o teu brinquedo apresentar um funcionamento fora do normal, desliga-o e consulta a secção de apoio no nosso site.

## CARGA

- Antes da primeira utilização do dispositivo de carga, verifica a tensão local, uma vez que a tensão local da rede elétrica não pode exceder a tensão máxima da rede elétrica indicada no dispositivo de carga.
- O dispositivo apenas deve ser alimentado com uma tensão de segurança extremamente baixa, correspondente à que se encontra indicada no aparelho.
- Não uses ou limpes o produto enquanto a bateria estiver a carregar.
- Nunca coloques o dispositivo de carga ou o cabo de carga dentro de água ou outros líquidos.
- Este aparelho contém pilhas que não podem ser substituídas.
- Este produto contém uma bateria recarregável de iões de lítio.
- Desliga o cabo de carregamento da tomada após cada processo de carregamento.

## PARA UMA UTILIZAÇÃO IDEAL DO PRODUTO SEGUIE AS SEGUINTE ORIENTAÇÕES:

- Para garantires uma longa duração da bateria, carrega o aparelho regularmente, mesmo que não seja utilizado.
- Guarda-o num local seguro e seco, sem exposição direta à luz do sol.
- Recomendamos a utilização de um lubrificante à base de água. Para evitar danos, não utilizes lubrificantes com perfume, à base de silicone ou de álcool, géis ou óleos de massagem.

## ACERCA DAS BATERIAS

Devido aos regulamentos europeus, somos obrigados a fornecer as seguintes informações:

- As baterias e acumuladores não devem ser deitados no lixo doméstico. O utilizador final é obrigado por lei a proceder à devolução das baterias usadas. Utilize os sistemas de recolha oficiais para este fim, como os pontos de recolha das empresas públicas de eliminação de resíduos. As baterias usadas que comercializamos ou temos comercializado como baterias novas também podem ser devolvidas a nós. Contate-nos para isso em [care@womanizer.com](mailto:care@womanizer.com). Para evitar curto-circuitos, os terminais das baterias de lítio devem ser colados antes de os devolver. Por razões de segurança, solicitamos que não nos envie as baterias pelos correios e que consulte os regulamentos para o envio de mercadorias perigosas das empresas postais.
- Se as baterias estiverem permanentemente instaladas no produto, não tente removê-las. Isto pode causar danos permanentes ao dispositivo. De resto, as suas obrigações como cliente são regidas pela diretiva REEE e a lei nacional de transposição.
- Para evitar desperdícios e lixo, as instruções do manual e as instruções de segurança devem ser seguidas.
- Os resíduos de baterias contêm substâncias nocivas que podem prejudicar o ambiente ou a sua saúde se não forem armazenados ou eliminados adequadamente. Isto aplica-se em particular ao manuseio inadequado de baterias contendo lítio. No entanto, as baterias também contêm matérias-primas importantes como ferro, zinco, manganês ou níquel e podem ser recicladas. A coleta seletiva possibilita a reciclagem dessas matérias-primas e evita os efeitos negativos dos poluentes libertados sobre o ambiente e a saúde humana.
- O símbolo constituído por um contentor de lixo barrado por uma cruz significa que o utilizador não deve se descartar de baterias e acumuladores no lixo doméstico.



Em cumprimento dos requisitos legais, por baixo do símbolo do contentor de lixo os seguintes símbolos químicos com os respetivos significados devem ser utilizados para identificar as baterias:

- Hg: A bateria contém um teor ponderal de mercúrio superior a 0,0005 %
- Pb: A bateria contém um teor ponderal de chumbo superior a 0,004 %
- Cd: A bateria contém um teor ponderal de cádmio superior a 0,002 %

## INFORMAÇÕES SOBRE O DESCARTE DE EQUIPAMENTOS ELÉTRICOS

Devido aos regulamentos europeus, somos obrigados a fornecer as seguintes informações:

- Informamos aos proprietários de equipamentos elétricos que os resíduos de equipamentos elétricos e eletrónicos (REEE) devem ser recolhidos separadamente dos resíduos municipais de acordo com as normas legais aplicáveis. As baterias e acumuladores que não estejam firmemente contidos nos REEE, bem como as lâmpadas que possam ser removidas dos REEE sem serem destruídas, devem ser separadas dos REEE sem destruição antes de serem entregues a um ponto de recolha e levadas para um ponto de eliminação designado. Para a eliminação de baterias, consulte as instruções em separado. O símbolo de um contentor de lixo com rodas barrado por uma cruz mostrado abaixo e aplicado aos REEE indica adicionalmente a obrigação de recolher separadamente:

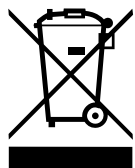

- De acordo com a diretiva REEE e a lei nacional de transposição, nós como distribuidores de equipamentos elétricos e eletrónicos somos obrigados a aceitar de volta certos resíduos sem encargos.
- Ao adquirir um equipamento elétrico e eletrónico novo, pode entregar-nos gratuitamente um resíduo de equipamento que cumpre essencialmente as mesmas funções que o novo equipamento. Se o seu REEE não for maior que 25 centímetros em qualquer dimensão, também nos pode entregá-lo gratuitamente sem comprar um equipamento novo. Contate-nos para isso em [care@womanizer.com](mailto:care@womanizer.com). Organizaremos então a devolução do resíduo de equipamento. Por razões de segurança, solicitamos que não nos envie luminárias (como lâmpadas, por exemplo). Utilize os sistemas de recolha das autoridades públicas de gestão de resíduos para a devolução dos dispositivos de iluminação ou contate-nos diretamente no endereço de e-mail acima mencionado.
- Pode também entregar resíduos de equipamentos elétricos e eletrónicos em todos os pontos de coleta das autoridades públicas de eliminação de resíduos. Ao enviar seus resíduos de equipamento para a recolha separada nos grupos de coleta corretos, faz uma contribuição importante para a reutilização, reciclagem e outros tipos de recuperação de REEE.
- Como utilizador final, é responsável pela remoção dos dados pessoais dos REEE a eliminar antes de os entregar.
- Para evitar desperdícios e lixo, as instruções do manual e as instruções de segurança devem ser seguidas e as opções de reparação devem ser verificadas. tamente no endereço de e-mail acima mencionado.

# GENERAL INFORMATION

## ELECTRICAL RATING

**Model:** OG

**Model No.:** TES10A

**Power Input:**

3,7 V=0,62 A: Built-in Li-Polymer rechargeable battery.

5 V=0,5 A: When charged using USB.

Use USB AC adaptor (not included) with power output corresponding to product rating. Use original provided cable only."

## CONTENT OF DELIVERY

Womanizer OG G-Spot vibrator, USB charging cable (AC adapter not included), cotton storage pouch, quick start guide, safety instructions

## ENVIRONMENTAL PROTECTION

As a distributor of electronic devices, we are legally obliged to accept the return of waste electrical and electronic devices free of charge. We expressly state that you as the user are legally obliged to return used batteries.

Never throw away electronic devices or batteries in the household waste. The symbol shown below (crossed-out wheeled bin) is intended to expressly remind you of this.

## MANUFACTURED AND DISTRIBUTED BY

**WOW Tech Europe GmbH**

Hermann-Blankenstein-Strasse 5

10249 Berlin

[www.wowtech.com](http://www.wowtech.com)

WOW Tech Europe GmbH reserves the right to make technical changes and changes to the design that serve to improve the device.

For information regarding patents see [womanizer.com/patents](http://womanizer.com/patents).

## CUSTOMER CARE

[care@womanizer.com](mailto:care@womanizer.com)

[womanizer.com](http://womanizer.com)

Designed in Germany. Made in China.

Date of issue: 10/2022.



# QUERES MAIS?

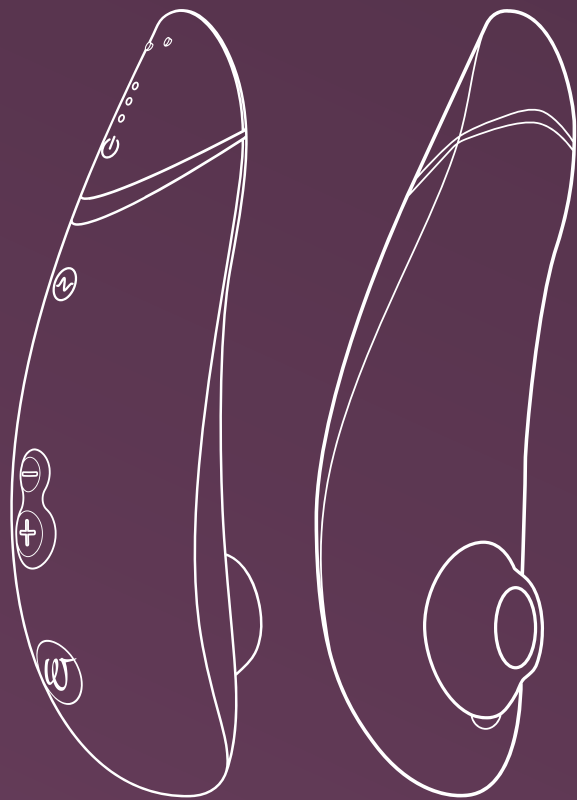

Pleasure Air  
Technology™



Autopilot



Smart Silence

**Premium 2**  
Define your luxury

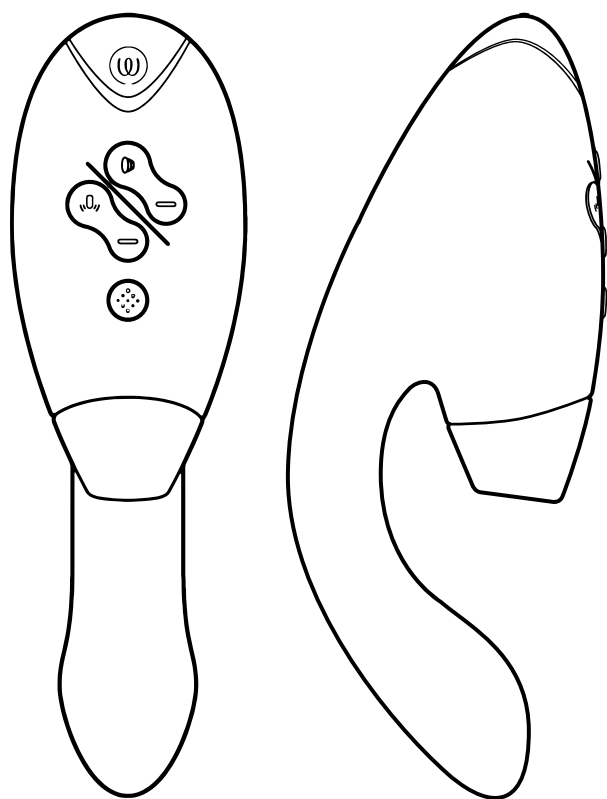

Pleasure Air  
Technology



Double Stimulation



Smart Silence

**Duo 2**  
Indulge in whole-body orgasms



#IMASTURBATE

# Hi!

Grazie per avere scelto **WOMANIZER OG**.

Ti diamo il benvenuto in un mondo pieno di esperienze sensuali che arricchiranno te e la tua vita. Scegliendo **WOMANIZER**, non solo ti garantisci orgasmi senza confronti, ma anche una brama di piacere senza precedenti.

Goditi il tuo **WOMANIZER OG** - un orgasmo dopo l'altro.

Amati!





**DESCRIZIONE**

**GUIDA ALL'UTILIZZO**

**SMART SILENCE**

**PULIZIA**

**RICARICA**

**SAFETY INSTRUCTIONS**

**INFORMAZIONI GENERALI**

Please read the safety instructions in the  
Compliance & Safety Information before first use.

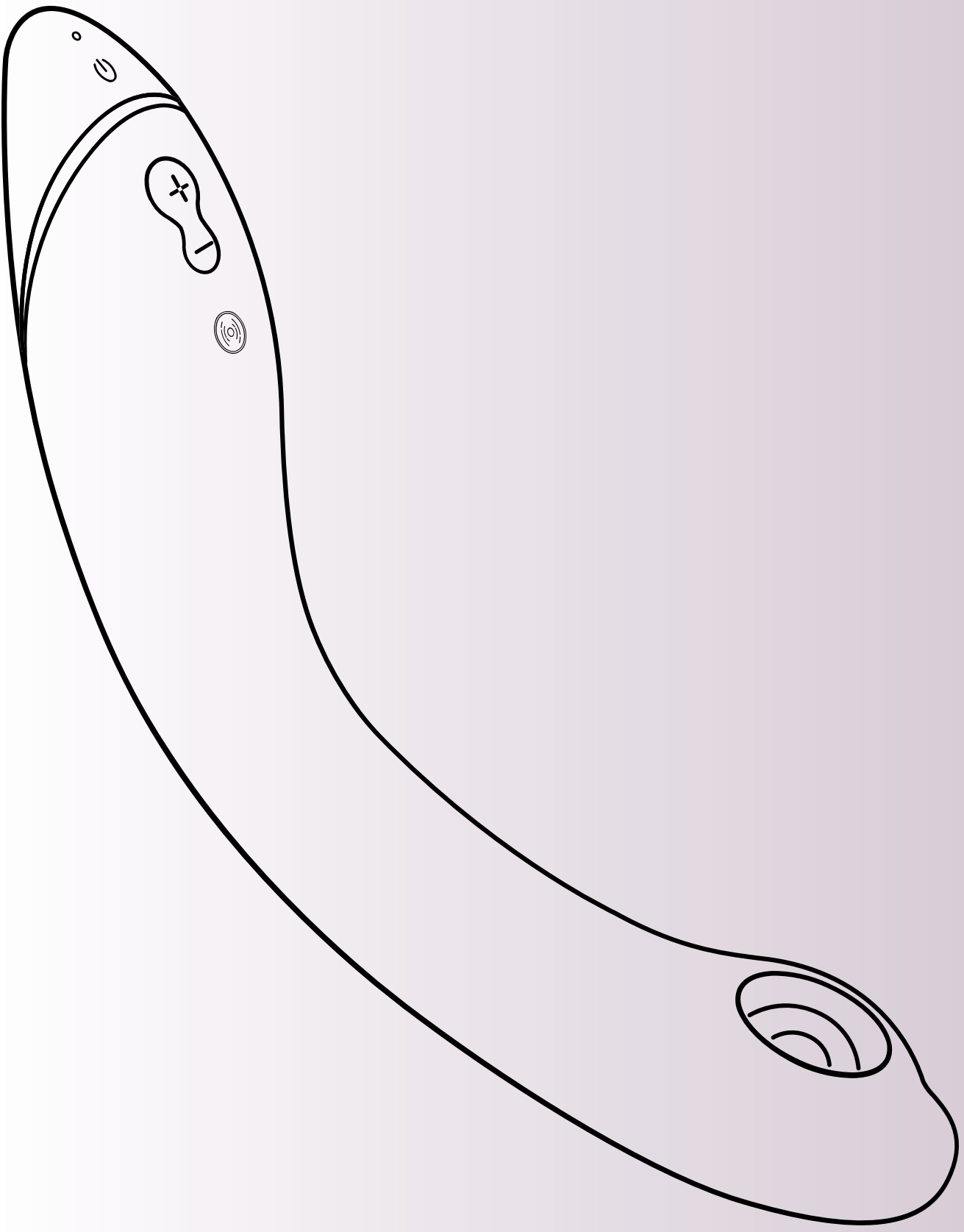

# DESCRIZIONE

**Display a LED**  
Accensione/Ricarica

**Smart Silence**  
accensione/  
spegnimento  
Premi per 2 secondi

**Vibrazione**  
Premi brevemente  
per attivare e  
aumentare  
l'intensità  
(3 livelli)

**Pleasure Air Technology**  
(12 livelli)

**Accensione/spegnimento** Pre-  
mi per 2 secondi

**Aumentare l'intensità**  
Premi brevemente (+)

**Diminuire l'intensità**  
Premi brevemente (-)

**Afterglow**  
Premi (-) per 1 secondo



# GUIDA ALL'UTILIZZO

## 1. Accensione

Premi per 2 secondi.  
Il LED indicherà che il  
prodotto è acceso.

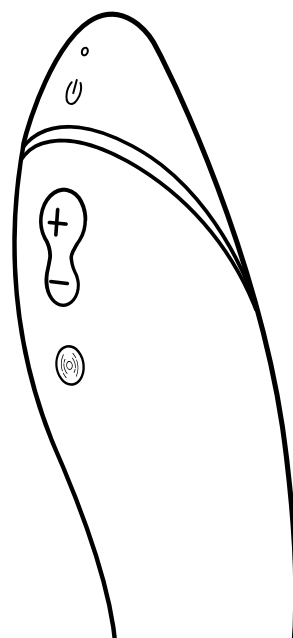

## 2. Utilizzo

Usa prima **OG** sul clitoride  
per fare un po' di riscaldamento.

Aggiungi lubrificante a  
base d'acqua sul corpo di **OG**.

Una volta che ci hai preso  
gusto, inserisci **OG** ed esplora  
il tuo punto G!

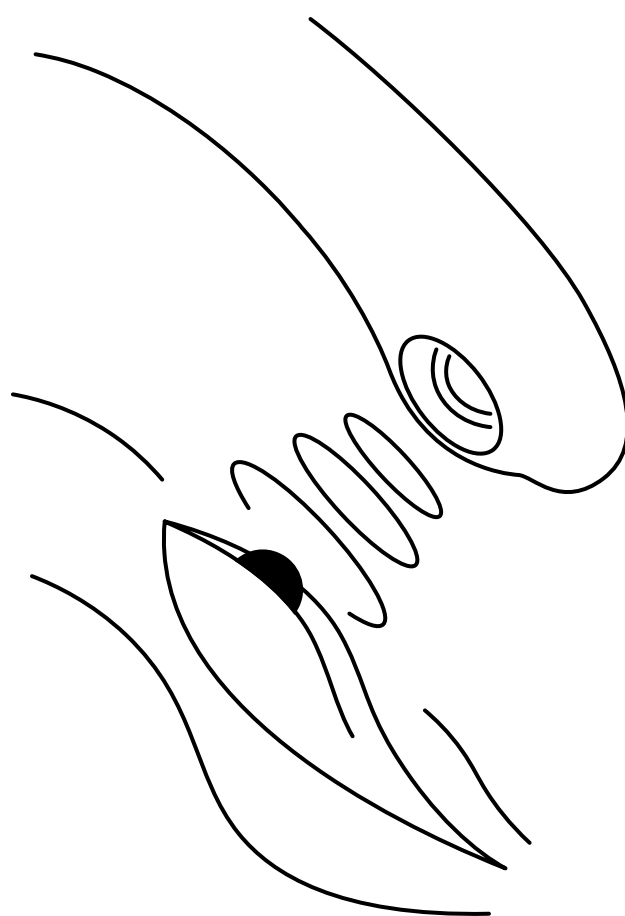

# GUIDA ALL'UTILIZZO

## 3. Cambio intensità

### Aumento

Premi brevemente

**12 livelli di intensità**

### Aumento

Premi brevemente

**3 livelli di vibrazione**

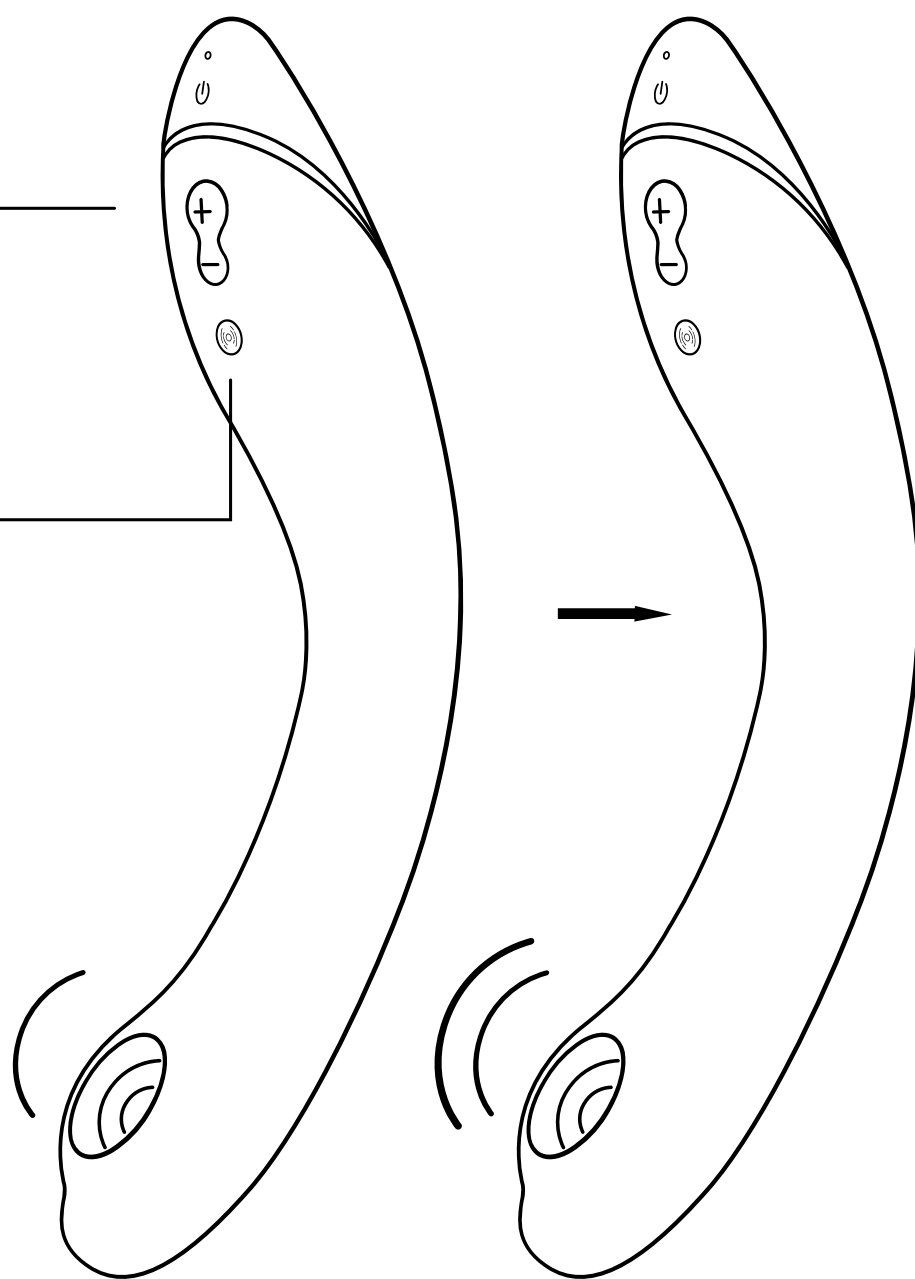

### Diminuzione

Premi brevemente

### Afterglow

Premi (-) per 1 secondo  
per tornare al livello di  
intensità 1

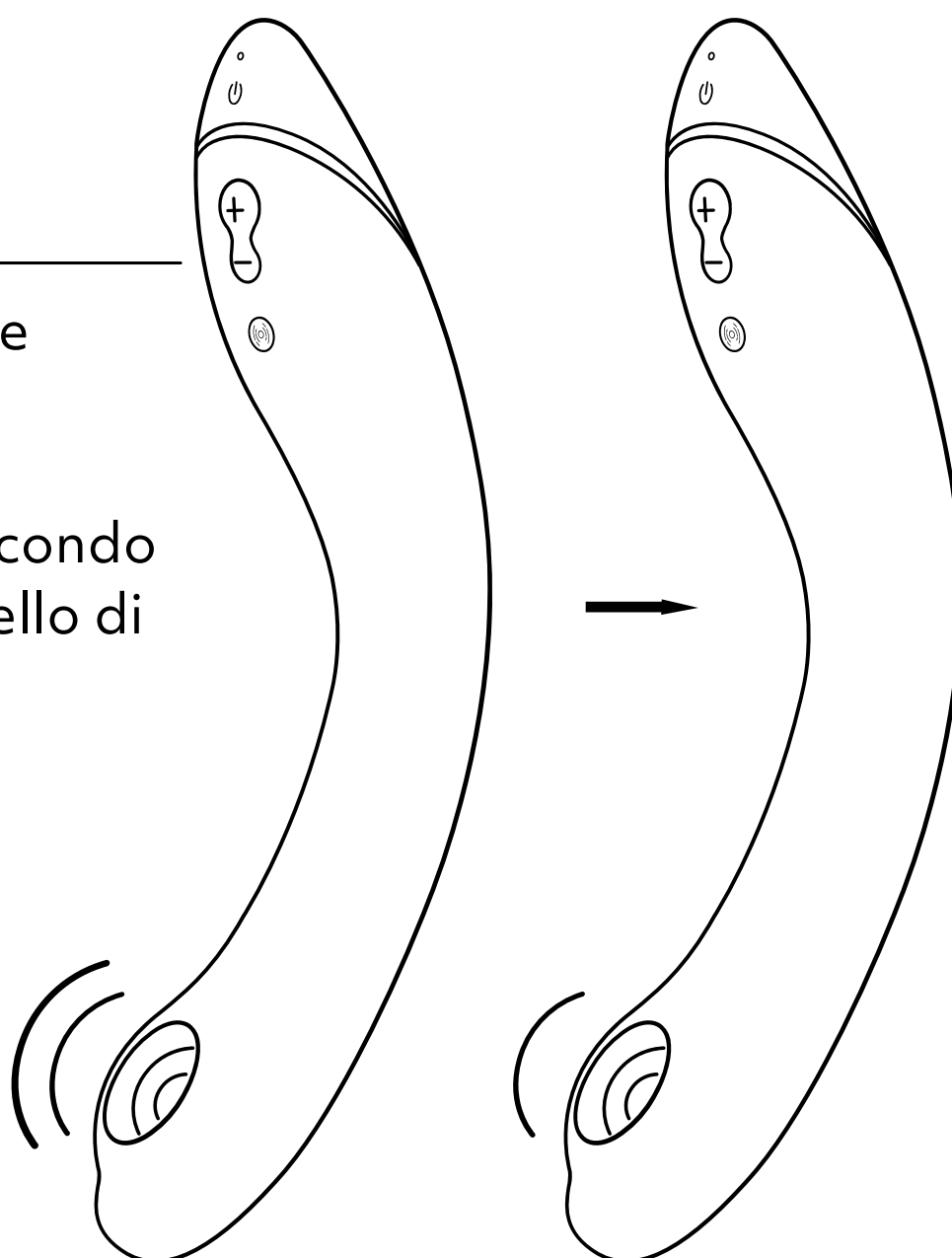

# GUIDA ALL'UTILIZZO

4. **Spegnimento** •  
Premi per 2 secondi.

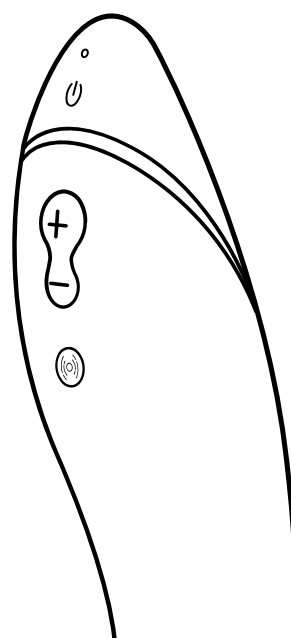

## SMART SILENCE

**OG** si attiva solo quando è quasi a contatto con la pelle. L'opzione Smart Silence è attivata per impostazione predefinita. Tieni premuti i pulsanti più e meno per 2 secondi per attivare o disattivare la funzione Smart Silence.

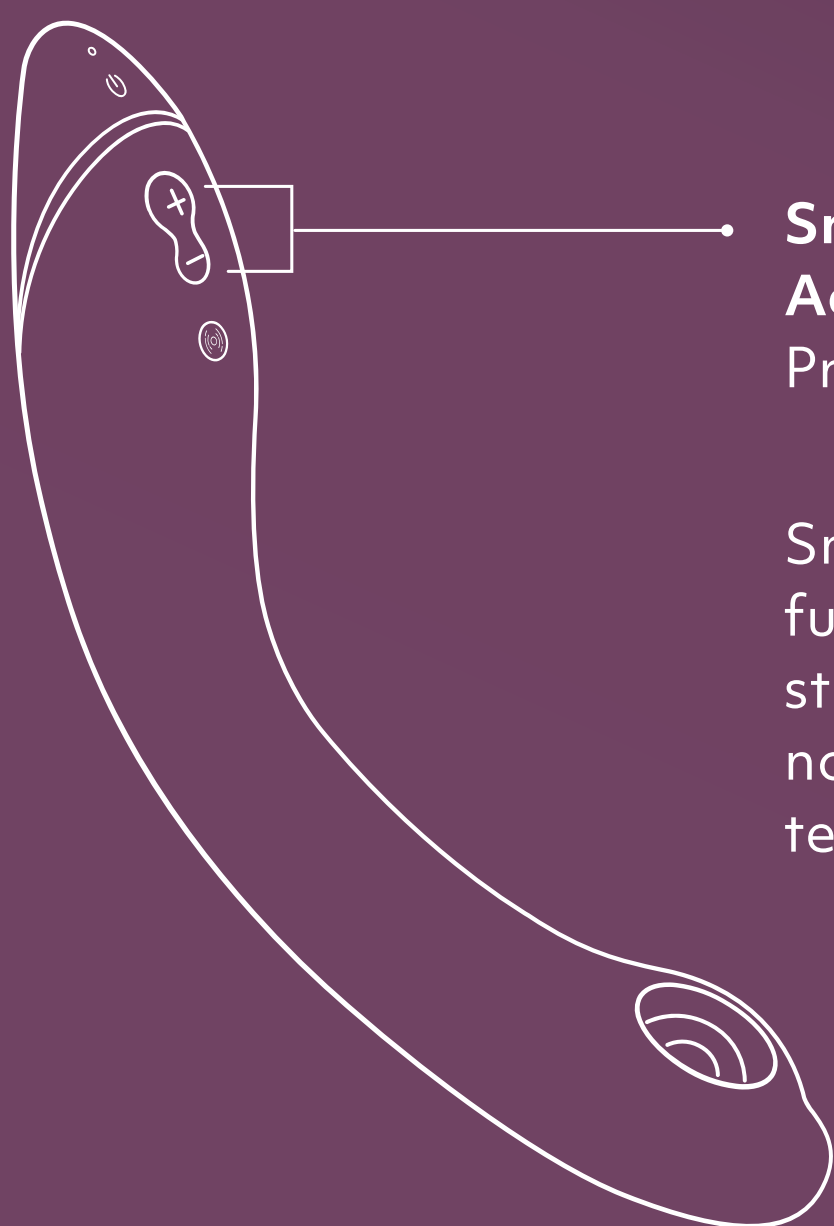

**Smart Silence**  
**Accensione/spegnimento**  
Premi per 2 secondi.

Smart Silence potrebbe non funzionare quando la testina di stimolazione è bagnata. Quindi non applicare il lubrificante sulla testina Pleasure Air.

# PULIZIA

Lava sotto l'acqua.

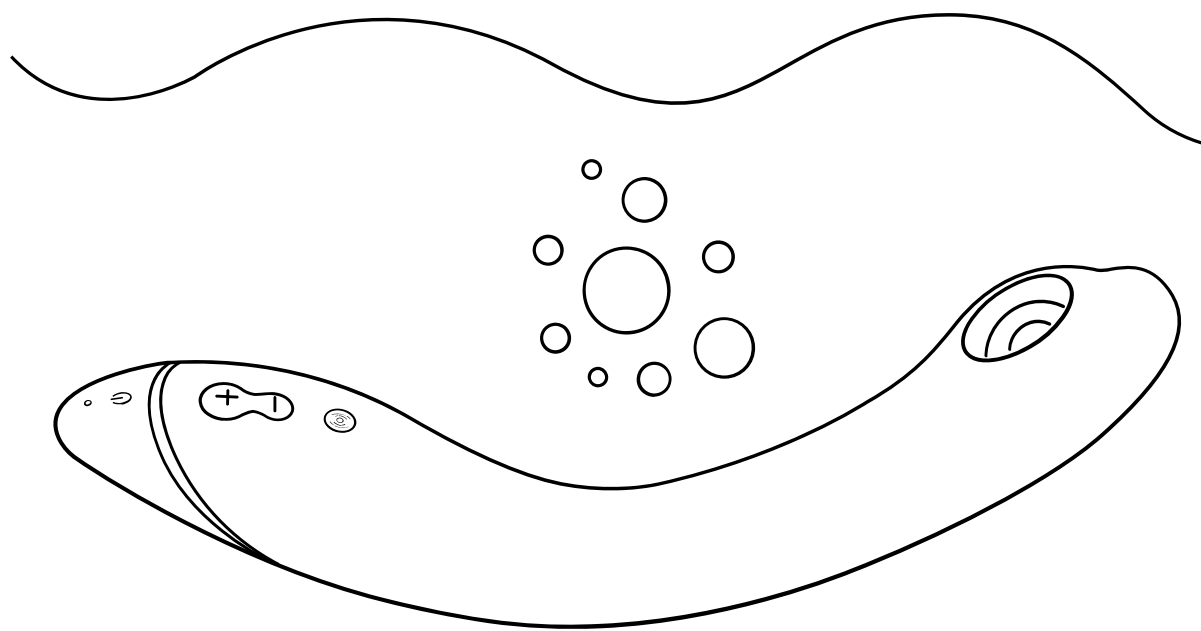

Applica il detergente.

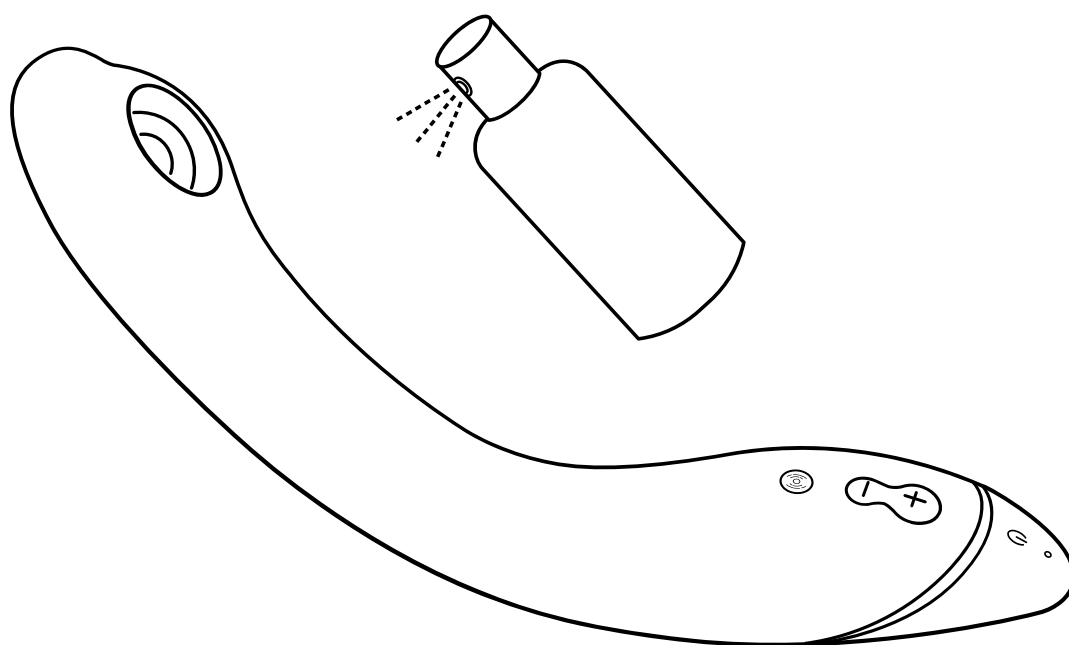

Asciuga accuratamente senza fare troppa pressione sulla membrana.

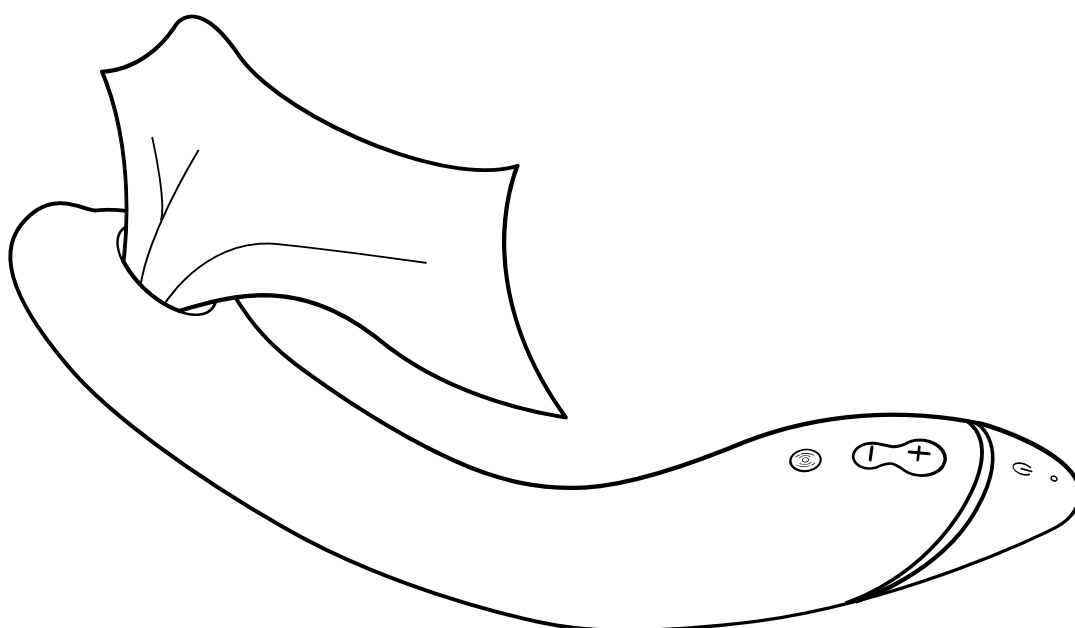

Impermeabile  
(IPX7)

# RICARICA

Ricarica tuo **OG** prima del primo utilizzo. Ricorda di ricaricare regolarmente il tuo OG, per garantire una lunga durata della batteria.

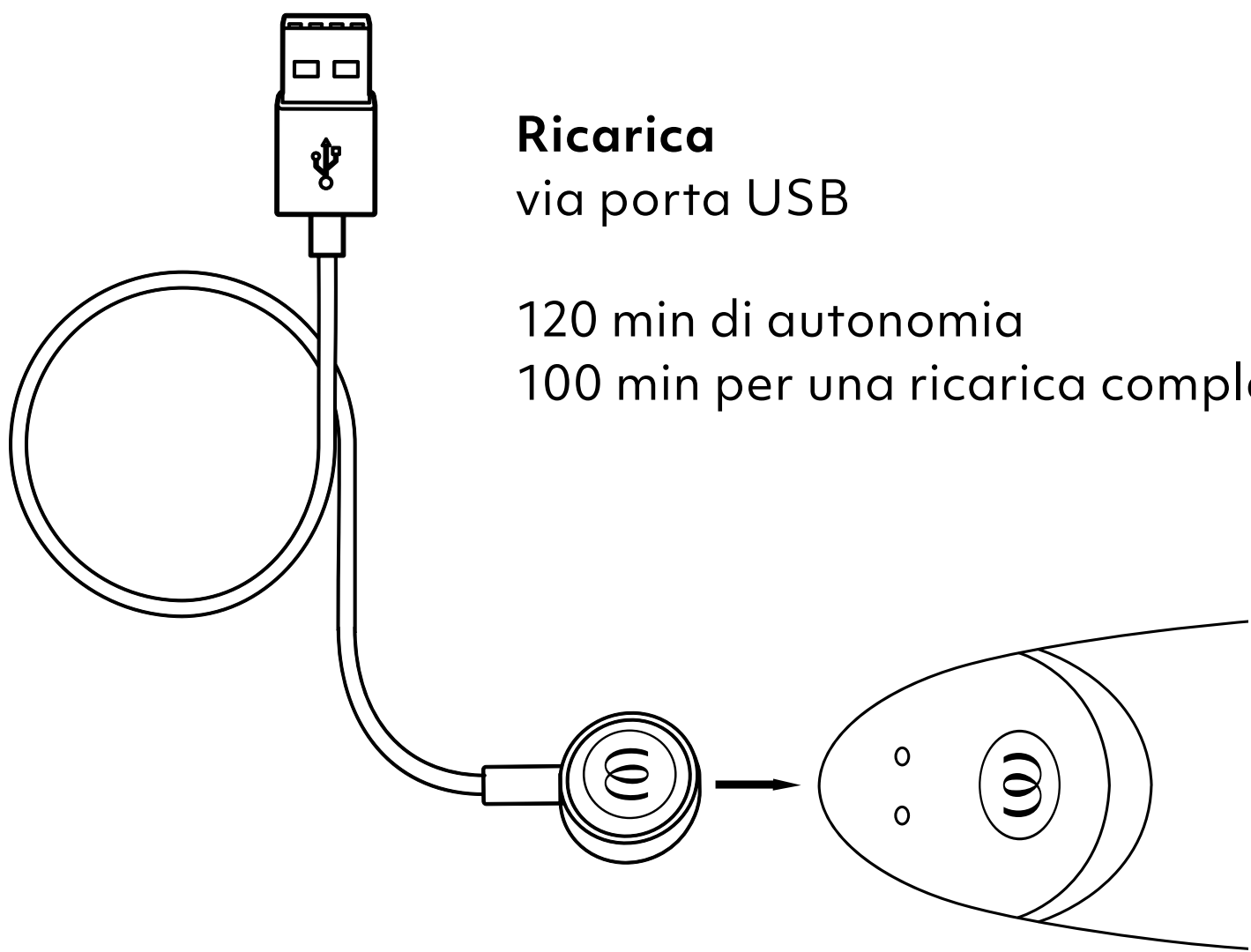

**Ricarica**  
via porta USB

120 min di autonomia  
100 min per una ricarica completa

---

## LED

Accensione/spegnimento/ricarica

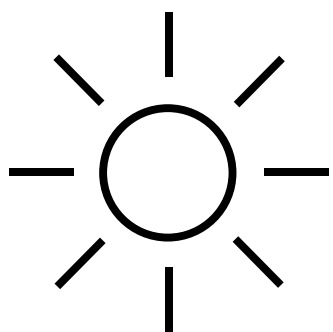

**Carica completa**  
Il LED emette segnali  
luminosi continui

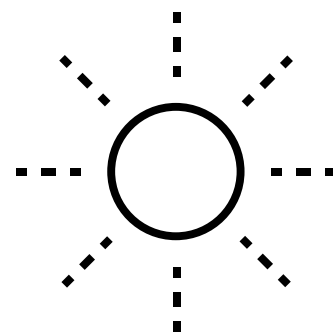

**Ricarica**  
Il LED lampeggia



# SAFETY INSTRUCTIONS

## ATTENZIONE

Venduto solo come novità. Utilizzare il prodotto solo per lo scopo previsto. Tenere il prodotto lontano dalla portata dei bambini. Non adatto a scopi medici. Se siete in cura da uno specialista e/o soffrite di un problema che richiede l'uso di un dispositivo medico, consultate il vostro medico prima di utilizzare questo prodotto. Interrompere immediatamente l'uso del prodotto in caso di irritazioni cutanee, dolore o disagio e rivolgetevi al vostro medico.

Questo apparecchio può essere utilizzato solo da adulti e da persone con ridotte capacità fisiche, sensoriali o mentali, oppure da persone prive di esperienza e conoscenza, solo se sotto la supervisione di una persona responsabile della loro sicurezza, che li abbia istruiti all'utilizzo dell'apparecchio in maniera sicura, e se ne hanno compreso i pericoli. I bambini non devono giocare con l'apparecchio. La pulizia e la manutenzione dell'apparecchio non devono essere effettuate da bambini. Non utilizzare su aree di pelle gonfie o infiammate.

- Prima dell'uso togliere piercing o gioielli nelle zone intime.
- Pulire sempre il prodotto prima e dopo l'uso secondo le istruzioni riportate nel manuale.
- Per evitare danni, il prodotto e la sua batteria non devono essere esposti a temperature superiori a 45°C, non devono essere smontati o danneggiati meccanicamente o elettricamente.
- La condivisione di giocattoli sessuali può trasmettere malattie sessuali. Non condividere i giocattoli sessuali con altre persone al di fuori del proprio partner. Se necessario, usare misure di protezione con il partner. Non utilizzare il giocattolo se si rilevano crepe o segni di deterioramento nel materiale di rivestimento.
- Questo apparecchio non è stato sviluppato per l'uso anale. Non utilizzare per via anale!
- Non posizionare il lato morbido del prodotto su una superficie assorbente per evitare macchie.
- Controllare regolarmente il caricabatteria e il giocattolo per verificare la presenza di eventuali danni e non utilizzare il dispositivo se i componenti sono danneggiati.
- I campi magnetici possono influenzare componenti meccanici ed elettronici, come per es. pacemaker. Non utilizzare il prodotto direttamente su un pacemaker. Per ulteriori informazioni rivolgersi al proprio medico. Non avvicinare al prodotto schede con bande magnetiche (per es. carte di credito), in quanto i magneti presenti nel prodotto potrebbero danneggiarle.
- Se il giocattolo sembra funzionare in modo anomalo, spegnetelo e consultate la sezione di assistenza sul nostro sito web.

## RICARICA

- Prima del primo utilizzo del caricabatteria, verificare la tensione di alimentazione locale, in quanto quest'ultima non deve superare la tensione di rete massima indicata sul caricabatteria.
- L'apparecchio deve essere alimentato solo a bassissima tensione di sicurezza corrispondente alla marcatura sull'apparecchio.
- Non utilizzare o pulire il prodotto mentre la batteria è in carica.
- Non immergere mai il caricabatteria o il cavo di ricarica in acqua o altri liquidi.
- Questo apparecchio contiene batterie non sostituibili.
- Questo prodotto contiene una batteria ricaricabile agli ioni di litio.
- Scollegare il cavo di ricarica dall'alimentazione elettrica dopo ogni ricarica.

## PER UN USO OTTIMALE DEL PRODOTTO, SEGUIRE LE SEGUENTI AVVERTENZE:

- Per garantire una lunga durata della batteria, si prega di ricaricare il dispositivo regolarmente, anche se non utilizzato.
- Conservare in un luogo sicuro e asciutto senza esposizione diretta alla luce del sole.
- Con il giocattolo, consigliamo di utilizzare un lubrificante a base di acqua. Per evitare danni, non utilizzare lubrificanti, gel o oli da massaggio profumati a base di silicone o a base alcolica.

## INDICAZIONI RELATIVE ALLO SMALTIMENTO DELLE BATTERIE

In ottemperanza alle normative europee siamo tenuti a dare le seguenti indicazioni:

- Le batterie e le batterie ricaricabili non devono essere smaltite nei rifiuti domestici. Il consumatore ha l'obbligo per legge di smaltire le batterie esauste. Usare i centri di raccolta ufficiali adibiti a questo scopo, come i punti di raccolta delle aziende pubbliche di smaltimento dei rifiuti.

- Le batterie esauste che diamo in dotazione come batterie nuove possono anche essere restituite a noi.
- Per assistenza si prega di contattare [care@womanizer.com](mailto:care@womanizer.com). Per evitare cortocircuiti, i terminali delle batterie al litio devono essere coperti con nastro isolante prima della restituzione. Per motivi di sicurezza, invitiamo a non inviare le batterie tramite posta e di attenersi al regolamento dell'operatore postale riguardante l'invio di merci pericolose."
- Le batterie che sono installate in modo fisso al prodotto, non devono in nessun modo essere rimosse di propria iniziativa, altrimenti l'apparecchio potrebbe subire danni permanenti. Gli obblighi del consumatore sono altresì regolati dalle direttive WEEE e dalle leggi nazionali.
- Per ridurre la produzione e l'accumulo di rifiuti, occorre attenersi alle istruzioni del manuale e le avvertenze sulla sicurezza.
- Le batterie esauste contengono sostanze inquinanti che possono recare danno all'ambiente o alla salute se non conservate o smaltite correttamente. Questo pericolo è particolarmente alto per le batterie al litio. Le batterie contengono, inoltre, importanti materie prime come ferro, zinco, manganese o nichel che possono essere riutilizzate. La raccolta differenziata permette il riutilizzo di queste materie prime ed evita l'impatto di sostanze inquinanti sull'ambiente e sulla salute umana.
- Il simbolo del bidone sbarrato indica che le batterie e le batterie ricaricabili non devono essere smaltite nei rifiuti domestici.

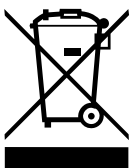

Sotto questo simbolo devono essere utilizzate, a norma di legge, le seguenti sigle (il cui significato è riportato di seguito) per contrassegnare le batterie:

- Hg: La batteria contiene più di 0,0005 percento peso di mercurio
- Pb: La batteria contiene più di 0,004 percento peso di piombo
- Cd: La batteria contiene più di 0,002 percento peso di cadmio

## INDICAZIONI RELATIVE ALLO SMALTIMENTO DI APPARECCHIATURE ELETTRONICHE E ELETTRICHE

In ottemperanza alle normative europee siamo tenuti a dare le seguenti indicazioni:

- Segnaliamo ai proprietari di apparecchi elettronici ed elettrici che, in conformità con la normativa in vigore, i vecchi apparecchi devono essere raccolti separatamente dai rifiuti urbani. Le batterie e gli accumulatori che non sono montati in modo fisso agli apparecchi elettrici, nonché le lampade, che possono essere rimosse dall'apparecchio senza danno, devono essere separati nella loro interezza e essere consegnati al centro di smaltimento designato. Per lo smaltimento delle batterie, si prega di attenersi alle seguenti indicazioni. Il simbolo del bidone sbarrato mostrato qui sotto e apposto sugli apparecchi elettronici e elettrici indica l'obbligo di raccolta separata.

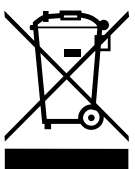

- Secondo le direttive WEEE e le leggi nazionali siamo obbligati, come distributori di apparecchi elettronici e elettrici, a ritirare gratuitamente alcuni vecchi apparecchi.
- Quando si acquista un nuovo apparecchio elettronico o elettrico, è possibile restituire gratuitamente il vecchio apparecchio se esso essenzialmente svolge le stesse funzioni del nuovo. Se il vecchio apparecchio non eccede i 25 cm su ogni lato, può essere restituito gratuitamente a prescindere dall'acquisto di un nuovo apparecchio. Per assistenza si prega di contattare [care@womanizer.com](mailto:care@womanizer.com). Organizzeremo la restituzione dei vecchi apparecchi elettronici. Per motivi di sicurezza si prega di non inviare apparecchi di illuminazione (come lampade). Per la restituzione degli apparecchi di illuminazione, si prega di utilizzare i punti di raccolta delle aziende pubbliche di smaltimento dei rifiuti o di contattarci direttamente all'indirizzo e-mail indicato sopra.
- Presso i punti di raccolta delle aziende pubbliche di smaltimento dei rifiuti è possibile consegnare anche i vecchi apparecchi elettronici o elettrici. Tramite la raccolta differenziata e la consegna dei vecchi apparecchi elettronici e elettrici presso gruppi di raccolta corretti si dà un importante contributo al riutilizzo, al riciclaggio e al recupero dei vecchi apparecchi.
- L'utente finale è responsabile della cancellazione dei dati personali sugli apparecchi da smaltire prima di consegnarli.
- Per ridurre la produzione di rifiuti, occorre seguire le istruzioni del manuale e le avvertenze sulla sicurezza, e informarsi sulle possibilità di riparazione.

# GENERAL INFORMATION

## ELECTRICAL RATING

**Model:** OG

**Model No.:** TES10A

**Power Input:**

3,7 V=0,62 A: Built-in Li-Polymer rechargeable battery.

5 V=0,5 A: When charged using USB.

Use USB AC adaptor (not included) with power output corresponding to product rating. Use original provided cable only."

## CONTENT OF DELIVERY

Womanizer OG G-Spot vibrator, USB charging cable (AC adapter not included), cotton storage pouch, quick start guide, safety instructions

## ENVIRONMENTAL PROTECTION

As a distributor of electronic devices, we are legally obliged to accept the return of waste electrical and electronic devices free of charge. We expressly state that you as the user are legally obliged to return used batteries.

Never throw away electronic devices or batteries in the household waste. The symbol shown below (crossed-out wheeled bin) is intended to expressly remind you of this.

## MANUFACTURED AND DISTRIBUTED BY

**WOW Tech Europe GmbH**

Hermann-Blankenstein-Strasse 5

10249 Berlin

[www.wowtech.com](http://www.wowtech.com)

WOW Tech Europe GmbH reserves the right to make technical changes and changes to the design that serve to improve the device.

For information regarding patents see [womanizer.com/patents](http://womanizer.com/patents).

## CUSTOMER CARE

[care@womanizer.com](mailto:care@womanizer.com)

[womanizer.com](http://womanizer.com)

Designed in Germany. Made in China.

Date of issue: 10/2022.



# VUOI ANCORA DI PIÙ?

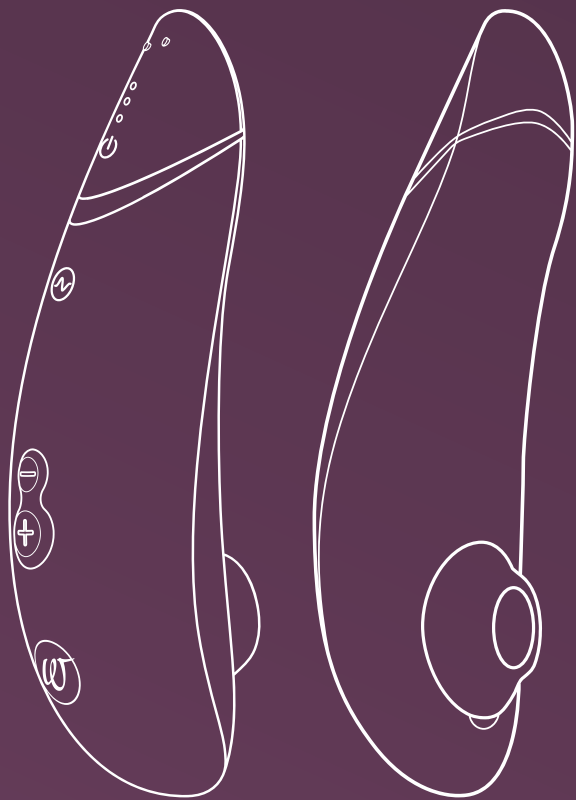

Pleasure Air  
Technology™



Autopilot



Smart Silence

**Premium 2**  
Define your luxury

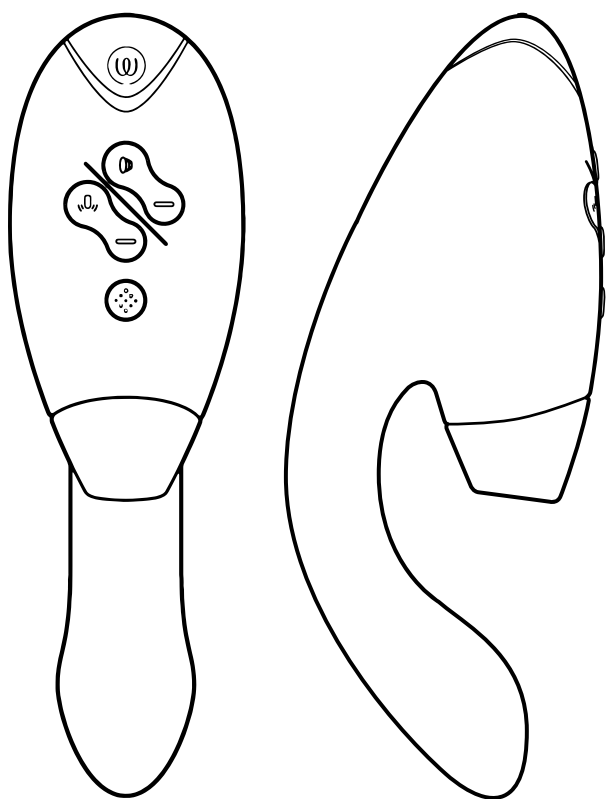

Pleasure Air  
Technology



Double Stimulation



Smart Silence

**Duo 2**  
Indulge in whole-body orgasms



#IMASTURBATE

# Hi!

Tak, fordi du valgte **WOMANIZER OG**.

Velkommen til en verden af sensuelle oplevelser, der vil berige dit liv. Dit valg af **WOMANIZER** garanterer dig ikke blot enestående orgasmer, men også en helt ny appetit på tilfredsstillelse.

Nyd din **WOMANIZER OG** – orgasme efter orgasme.

Elsk bare dig selv!



**BESKRIVELSE**

**BRUGSVEJLEDNING**

**SMART SILENCE**

**RENGØRING**

**OPLADNING**

**SAFETY INSTRUCTIONS**

**GENERELLE OPLYSNINGER**

Please read the safety instructions in the  
Compliance & Safety Information before first use.

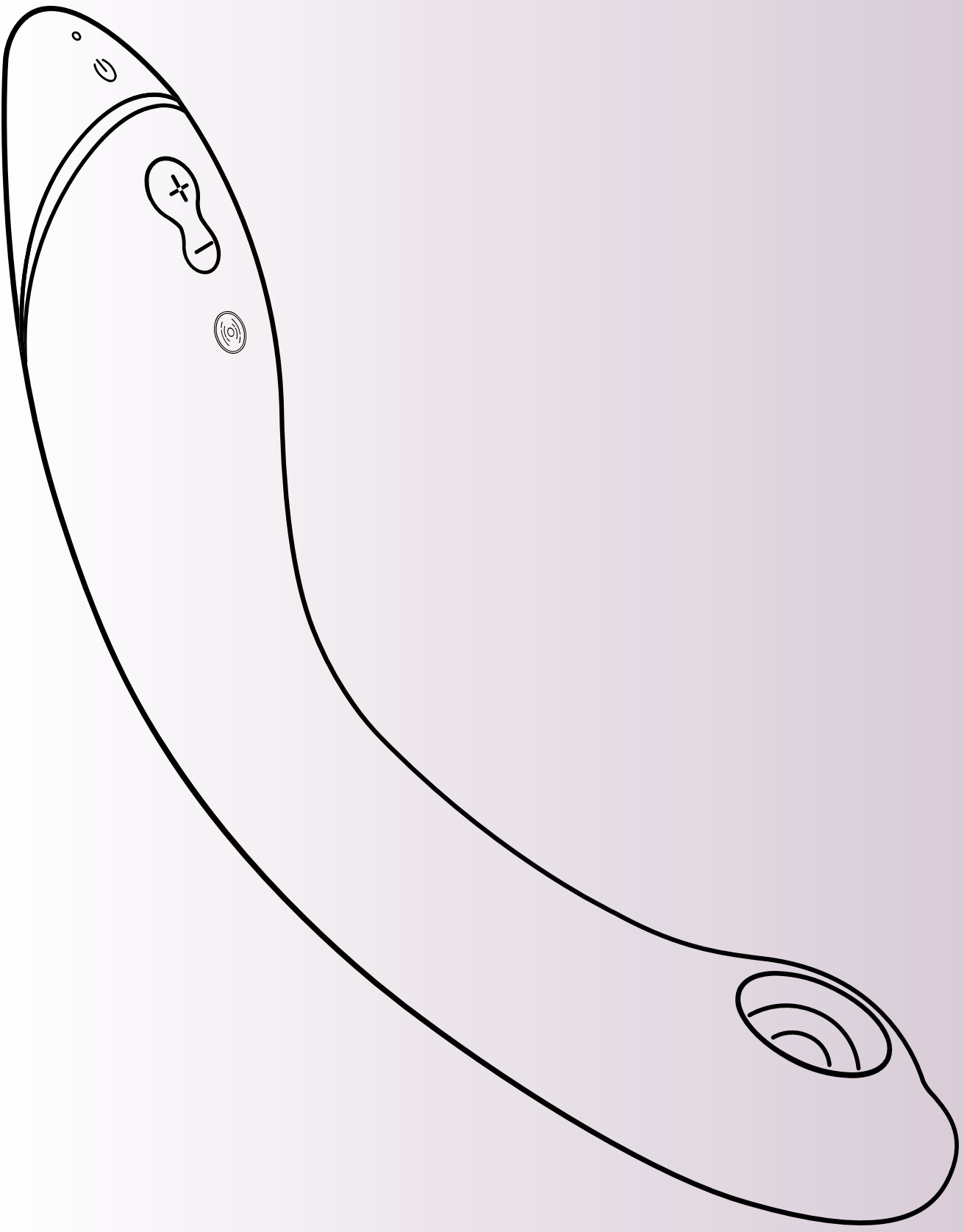



# BESKRIVELSE

**LED-display**  
Tændt/oplader

**Smart Silence til/fra**  
Tryk i 2 sekunder

**Vibrering**  
Tryk kortvarigt for at aktivere og øge intensiteten (3 niveauer)

**Pleasure Air Technology**  
(12 niveauer)

**Til/fra**  
Tryk i 2 sekunder

**Øg intensiteten**  
Tryk kortvarigt på (+)

**Reducer intensiteten**  
Tryk kortvarigt på (-)

**Afterglow**  
Tryk på (-) i 1 sekund



# BRUGSVEJLEDNING

## 1. Tænd

Tryk i 2 sekunder.  
LED'en vil indikere  
at produktet er tændt.

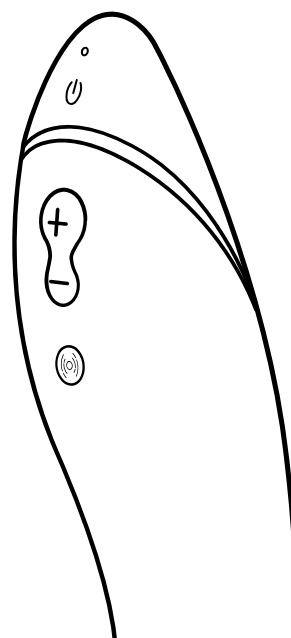

## 2. Brug

Start med at bruge **OG** på  
din klitoris for at komme  
i stemning.

Smør vandbaseret  
glidecreme på **OG**'ens krop.

Når du er varmet op, kan du  
sætte **OG**'en ind og udforske  
dit g-punkt!

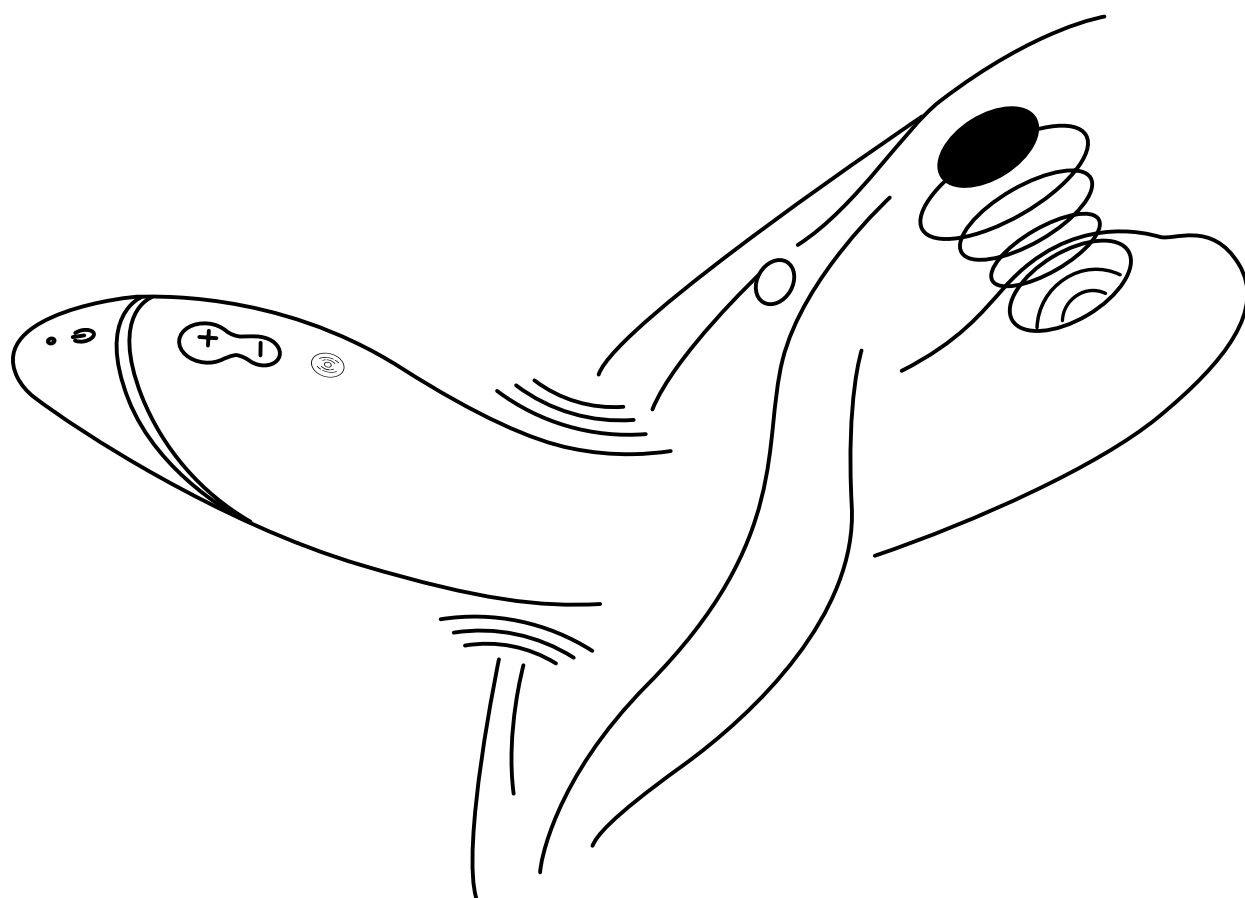
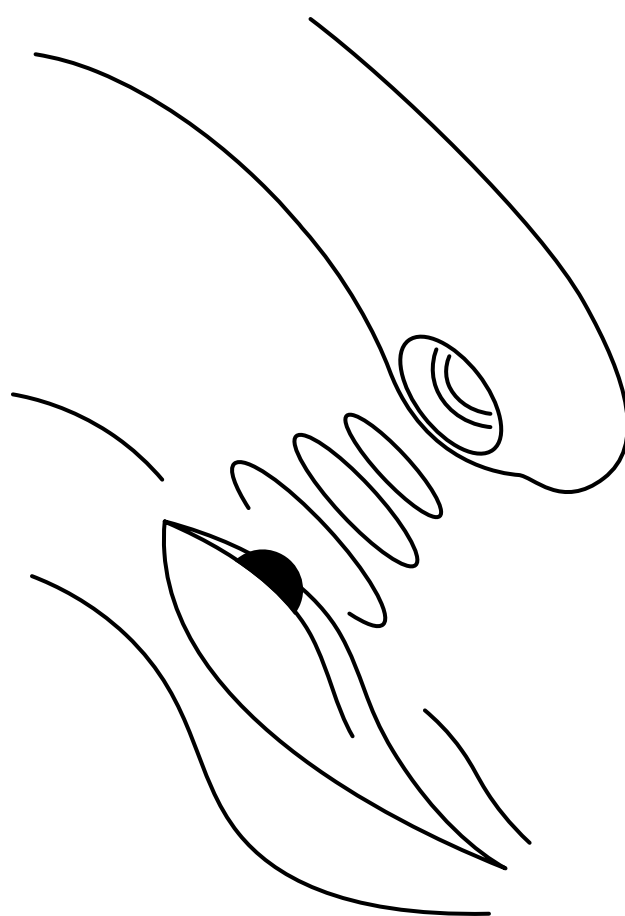

# BRUGSVEJLEDNING

## 3. Skift graden af intensitet

**Øg** —————  
Tryk kortvarigt  
**12 intensitetsniveauer**

**Øg** —————  
Tryk kortvarigt  
**3 vibrationsniveauer**

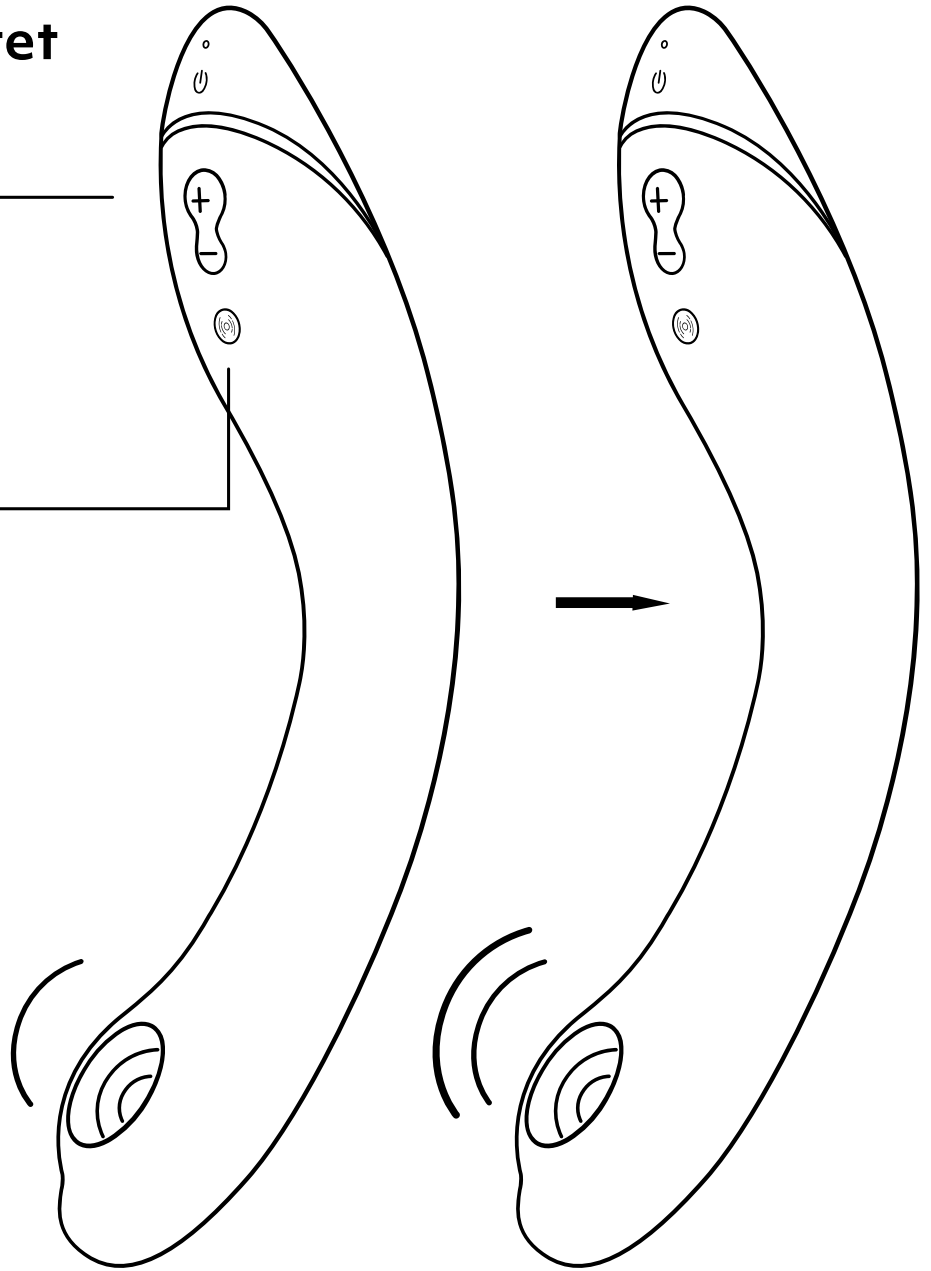

**Reducer** —————  
Tryk kortvarigt

**Afterglow**  
Tryk på (-) i 1 sekund  
for at gå tilbage til  
intensitetsniveau 1

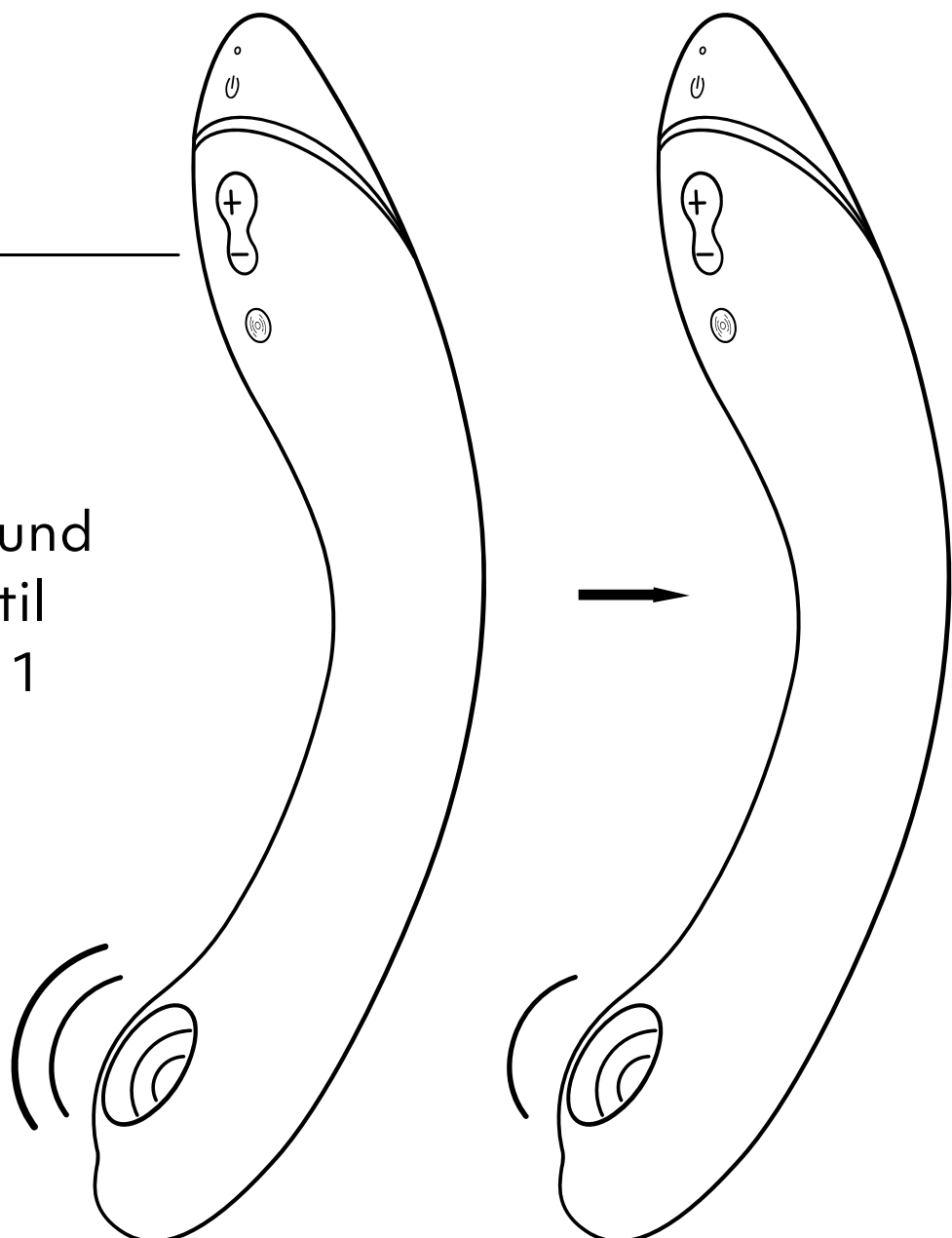

# BRUGSVEJLEDNING

4. **Sluk** —————  
Tryk i 2 sekunder.

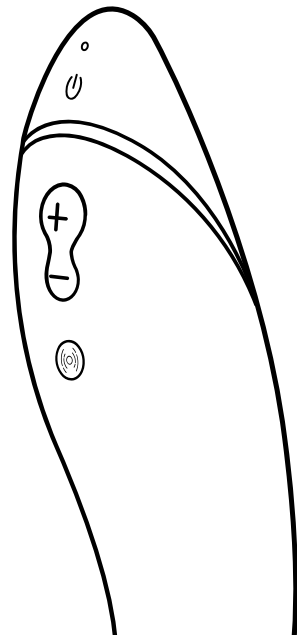

## SMART SILENCE

**OG**'en tænder kun, når den næsten rører din hud. Smart Silence vil være slået til som standard. For at slå Smart Silence til eller fra, skal du trykke på minusknapperne og holde dem nede i to sekunder.



**Smart Silence Til/fra**  
Tryk i 2 sekunder

Smart Silence fungerer ikke altid, når stimulationshovedet er vådt. Derfor skal du altid sikre dig, at der ikke kommer glidecreme ind i Pleasure Air-hovedet.

# RENGØRING

Vask under vand.

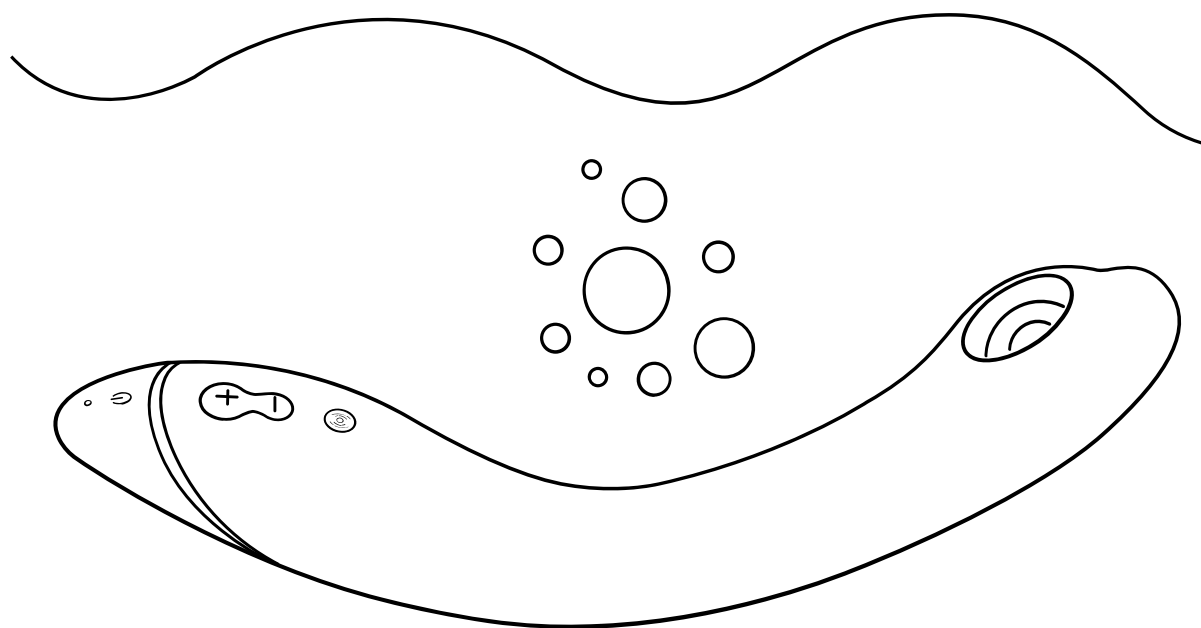

Brug rensmiddel til legetøj.

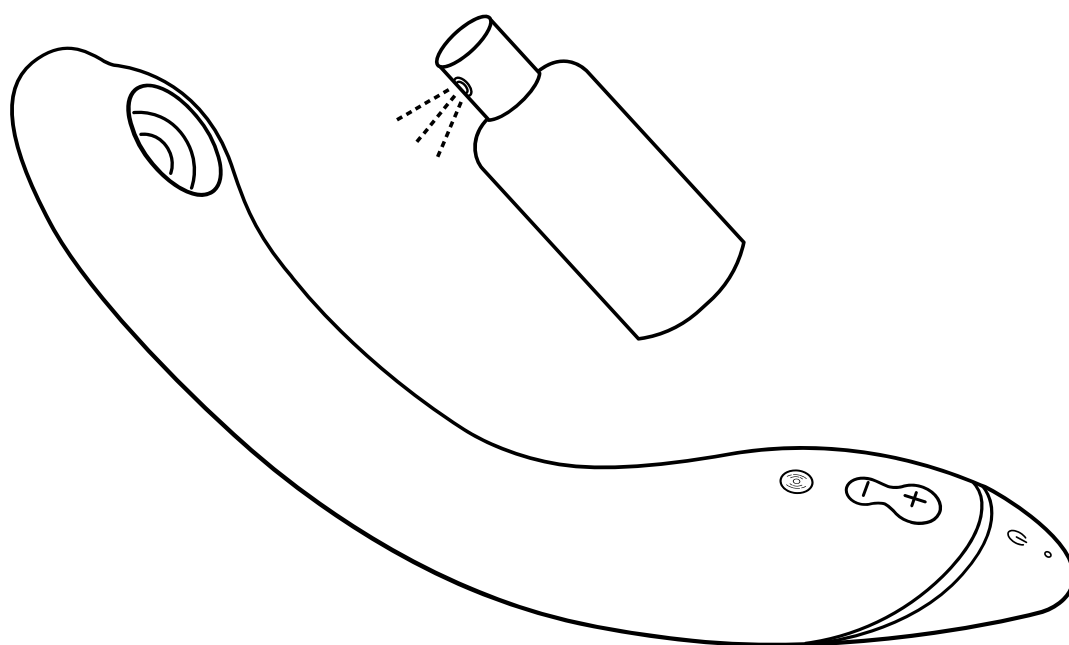

Tør forsigtigt uden at trykke for meget på membranen.

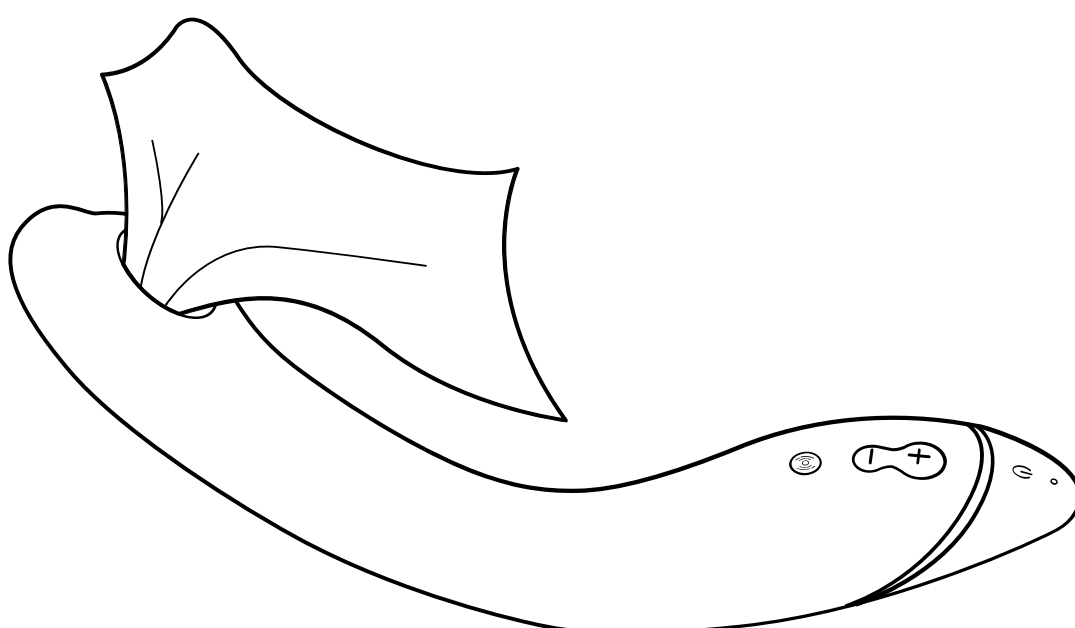

Vandtæt  
(IPX7)

# OPLADNING

Lad venligst din **OG** op før første brug. Husk også at lade din **OG** op med jævne mellemrum for at sikre langt batteriliv.

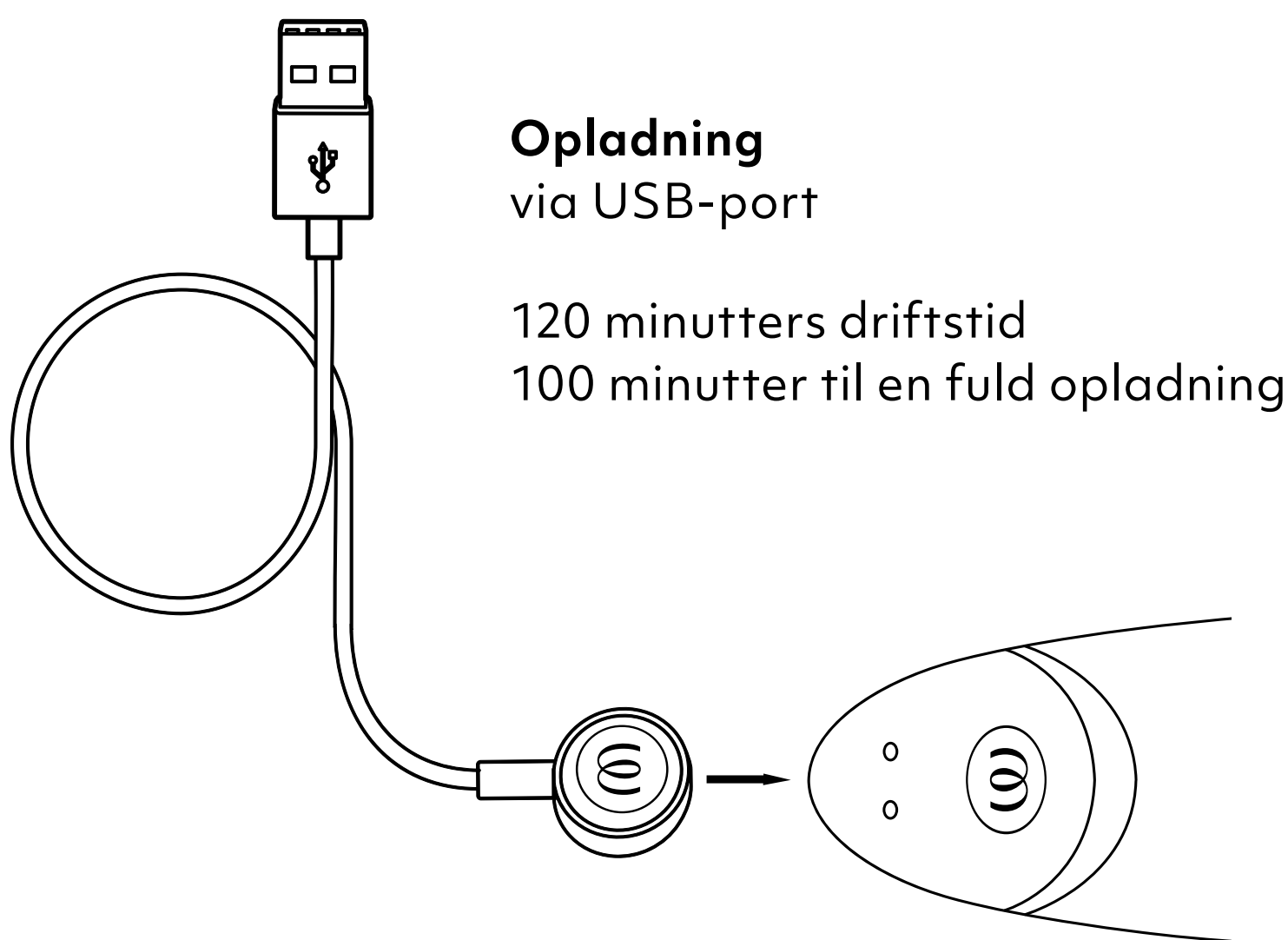

**Opladning**  
via USB-port

120 minutters driftstid  
100 minutter til en fuld opladning

---

## LED

Tændt/slukket/oplader

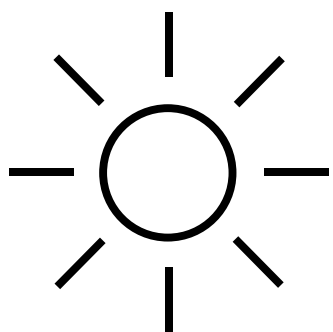

**Fuldt opladet**  
LED'en lyser konstant

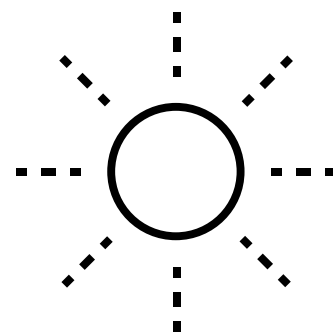

**Opladning**  
LED'en blinker

# SAFETY INSTRUCTIONS

## ADVARSEL

Sælges udelukkende som legetøj. Anvend udelukkende produktet til det tilsigtede formål. Hold produktet væk fra børn. Ikke egnet til medicinske formål. Hvis du behandles af en læge og/eller har en tilstand, der kræver brug af medicinsk udstyr, bedes du konsultere din læge, inden du anvender dette produkt. Stop omgående med at benytte produktet, hvis du oplever hudirritationer, smerter eller ubehag, og kontakt din læge.

Dette apparat kan udelukkende anvendes af voksne samt af personer med nedsatte fysiske, sansmæssige eller mentale evner eller manglende erfaring og viden, hvis de er under opsyn eller har modtaget vejledning i brugen af apparatet på en sikker måde og forstår de farer, der er forbundet med apparatet. Børn må ikke lege med apparatet. Rengøring og brugervedligeholdelse må ikke foretages af børn. Må ikke anvendes på hævede eller betændte hudområder.

- Fjern piercinger og smykker i kønsområdet inden brug.
- Rengør altid produktet før og efter brug i overensstemmelse med instruktionerne i manualen.
- For at undgå beskadigelse af produktet må produktet og dets batteri ikke udsættes for temperaturer over 45°C, afmonteres eller beskadiges mekanisk eller elektrisk.
- Deling af sexlegetøj kan overføre seksuelle sygdomme. Del ikke dit sexlegetøj med andre brugere end din partner. Brug beskyttelsesforanstaltninger med din partner om nødvendigt. Brug ikke legetøjet, hvis du opdager revner eller tegn på slitage i afdækningsmaterialet.
- Dette produkt er ikke designet til anal brug. Brug det ikke analt!
- Placer ikke den bløde side af dit produkt på en absorberende side, så du undgår pletter.
- Kontrollér regelmæssigt opladeren og legetøjet for skader, og anvend ikke enheden, hvis komponenter er beskadigede.
- Magnetfelter kan påvirke mekaniske og elektroniske komponenter såsom pacemakere. Brug ikke enheden direkte over pacemakeren. For mere information, kontakt din læge. Medbring ikke kort med magnetstriber (f.eks. kreditkort) i nærheden af enheden, da de kan blive beskadiget af magneterne på produktet.
- Hvis dit legetøj ser ud til at fungere unormalt, skal du slukke det og søge råd i supportsektionen på vores hjemmeside.

## OPLADNING

- Inden første brug af opladeren skal det lokale spændingsniveau undersøges, idet den lokale netspænding ikke må overskride den maksimale netspænding, der er angivet på opladeren.
- Apparatet må kun forsynes med meget lav spænding svarende til mærkningen på apparatet.
- Brug ikke og rengør ikke produktet, mens batteriet oplades.
- Nedsænk aldrig opladeren eller ladekablet i vand eller andre væsker.
- Dette apparat indeholder batterier, der ikke kan udskiftes.
- Dette produkt indeholder et genopladeligt li-ion-batteri.
- Frakobl ladekablet fra strømforsyningen efter hver opladningsproces.

## FØLG DISSE RETNINGSLINJER FOR EN OPTIMAL BRUG AF PRODUKTET:

- Oplad batteriet regelmæssigt, selv hvis det ikke benyttes, for at sikre en lang batterilevetid.
- Opbevares på et sikkert, tørt sted uden direkte sollys.
- Vi anbefaler, at du anvender et vandbaseret smøremiddel til dit legetøj. For at undgå skader: Anvend ikke parfumerede, silikonebaserede eller alkoholbaserede smøremidler, géler eller massageolier.

# GENERAL INFORMATION

## ELECTRICAL RATING

**Model:** OG

**Model No.:** TES10A

**Power Input:**

3,7 V=0,62 A: Built-in Li-Polymer rechargeable battery.

5 V=0,5 A: When charged using USB.

Use USB AC adaptor (not included) with power output corresponding to product rating. Use original provided cable only."

## CONTENT OF DELIVERY

Womanizer OG G-Spot vibrator, USB charging cable (AC adapter not included), cotton storage pouch, quick start guide, safety instructions

## ENVIRONMENTAL PROTECTION

As a distributor of electronic devices, we are legally obliged to accept the return of waste electrical and electronic devices free of charge. We expressly state that you as the user are legally obliged to return used batteries.

Never throw away electronic devices or batteries in the household waste. The symbol shown below (crossed-out wheeled bin) is intended to expressly remind you of this.

## MANUFACTURED AND DISTRIBUTED BY

**WOW Tech Europe GmbH**

Hermann-Blankenstein-Strasse 5

10249 Berlin

[www.wowtech.com](http://www.wowtech.com)

WOW Tech Europe GmbH reserves the right to make technical changes and changes to the design that serve to improve the device.

For information regarding patents see [womanizer.com/patents](http://womanizer.com/patents).

## CUSTOMER CARE

[care@womanizer.com](mailto:care@womanizer.com)

[womanizer.com](http://womanizer.com)

Designed in Germany. Made in China.

Date of issue: 10/2022.





# ØNSKER DU MERE?

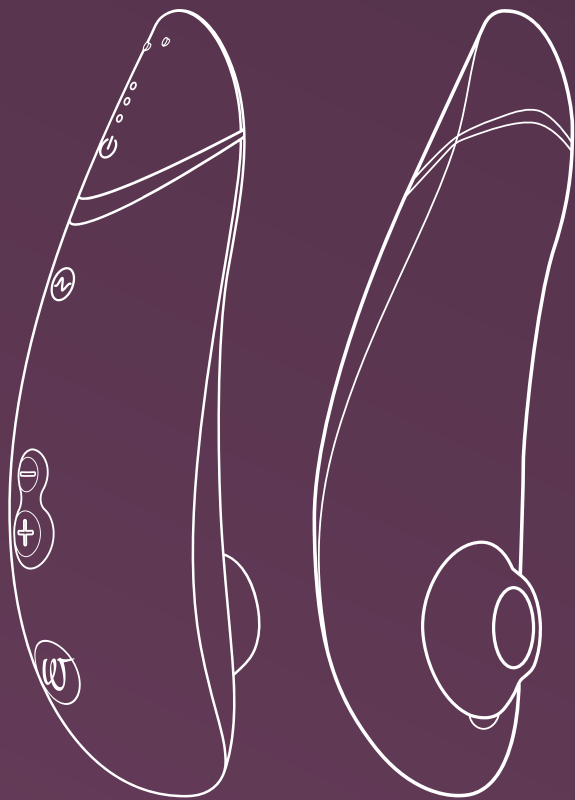

Pleasure Air  
Technology

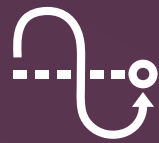

Autopilot



Smart Silence

**Premium 2**  
Define your luxury

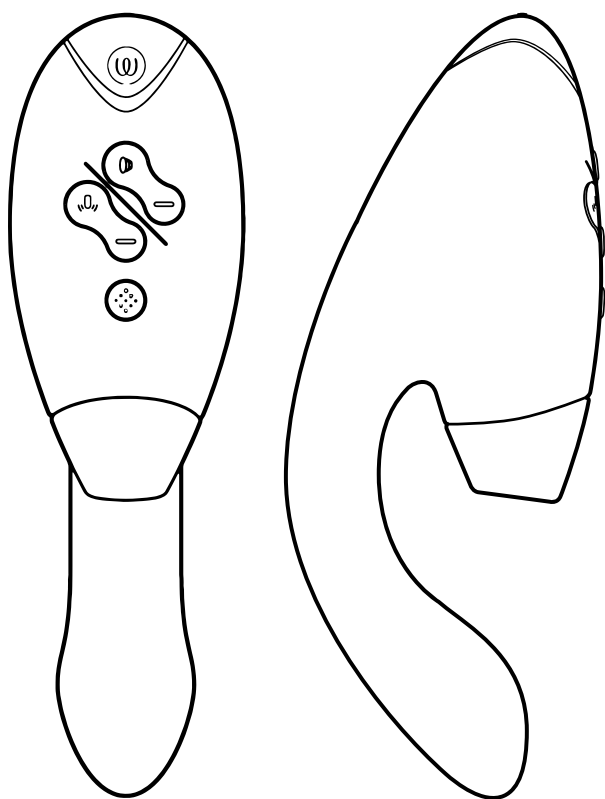

Pleasure Air  
Technology



Double Stimulation



Smart Silence

**DUO 2**  
Indulge in whole-body orgasms



#IMASTURBATE

# Hi!

Takk for at du valgte **WOMANIZER OG!**

Velkommen til en verden full av sensuelle opplevelser som vil berike livet ditt. Ved å velge **WOMANIZER**, garanteres du ikke bare orgasmer som ikke kan sammenlignes, men også en helt ny lyst etter nytelse.

Kos deg med **WOMANIZER OG** – fra den ene orgasmen til den neste.

Kom igjen, elsk deg selv!



**BESKRIVELSE**

**HVORDAN DEN BRUKES**

**SMART SILENCE**

**RENGJØRING**

**LADING**

**HEMMELIGE TIPS TIL HVORDAN  
DU KAN KOSE DEG MED  
WOMANIZER OG**

**SAFETY INSTRUCTIONS**

**GENERELL INFORMASJON**

Please read the safety instructions in the  
Compliance & Safety Information before first use.

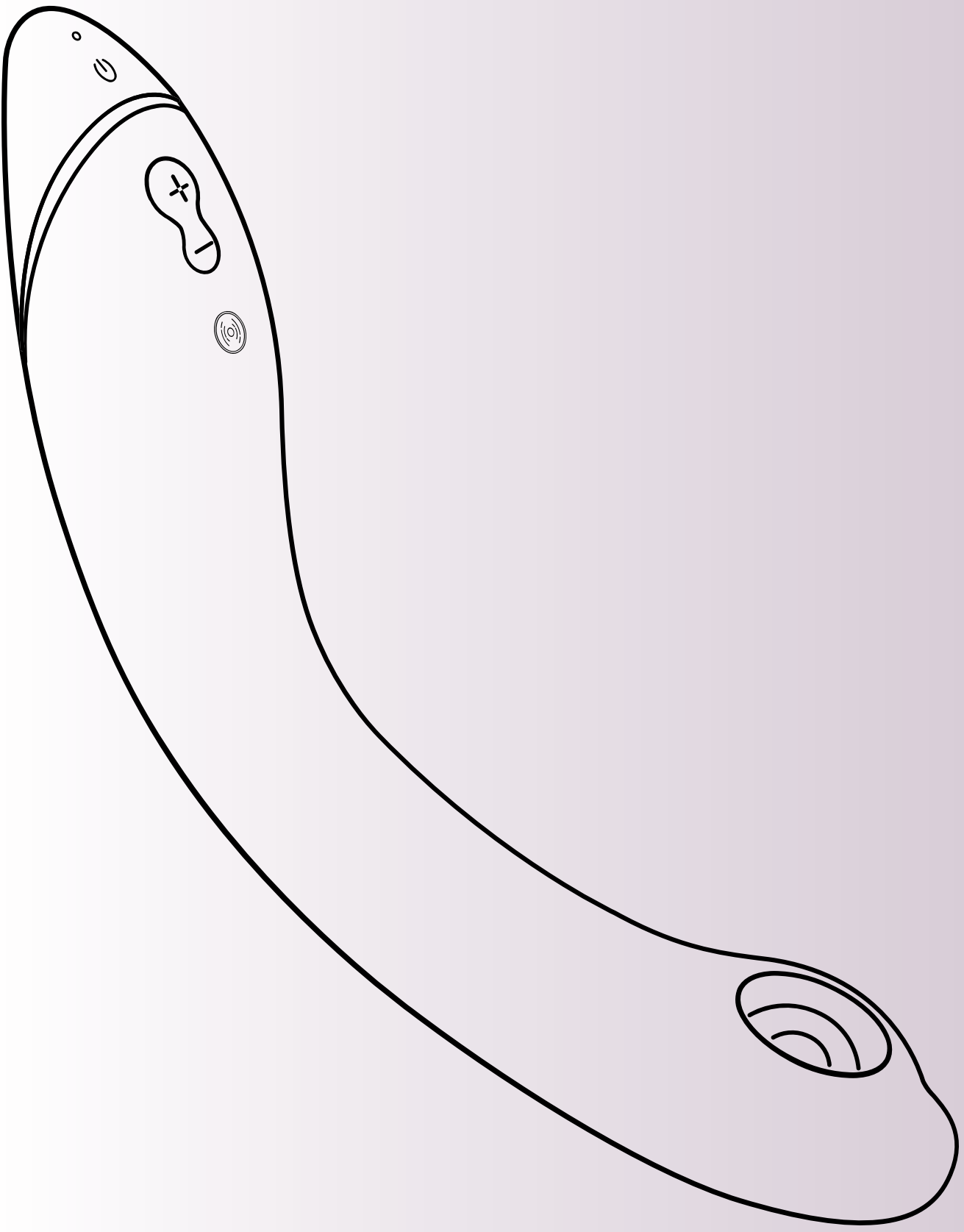

# BESKRIVELSE

**LED-skjerm**  
På/lading

**Smart Silence**  
Av/på  
Trykk i 2 sekunder

**Vibrasjon**  
Trykk kort for  
å aktivere og  
øke intensiteten  
(3 nivåer)

**Pleasure Air Technology**  
(12 nivåer)

**På/av**  
Trykk i 2 sekunder

**Øke intensiteten**  
Trykk kort på (+)

**Redusere intensiteten**  
Trykk kort på (-)

**Afterglow**  
Trykk på (-) i ett sekund



# HVORDAN DEN BRUKES

## 1. Slå på

Trykk i 2 sekunder.  
LED-lampen vil indikere  
at produktet er slått på.

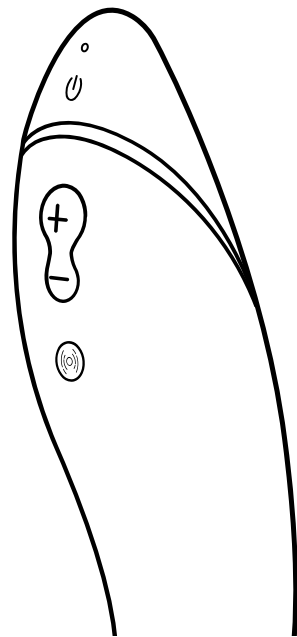

## 2. Bruk

Bruk **OG** på klitoris først,  
for å komme i humøret.

Ha vannbasert glidemiddel  
på **OG**.

Når du er opphisset, sett inn  
**OG** og utforsk g-punktet ditt!

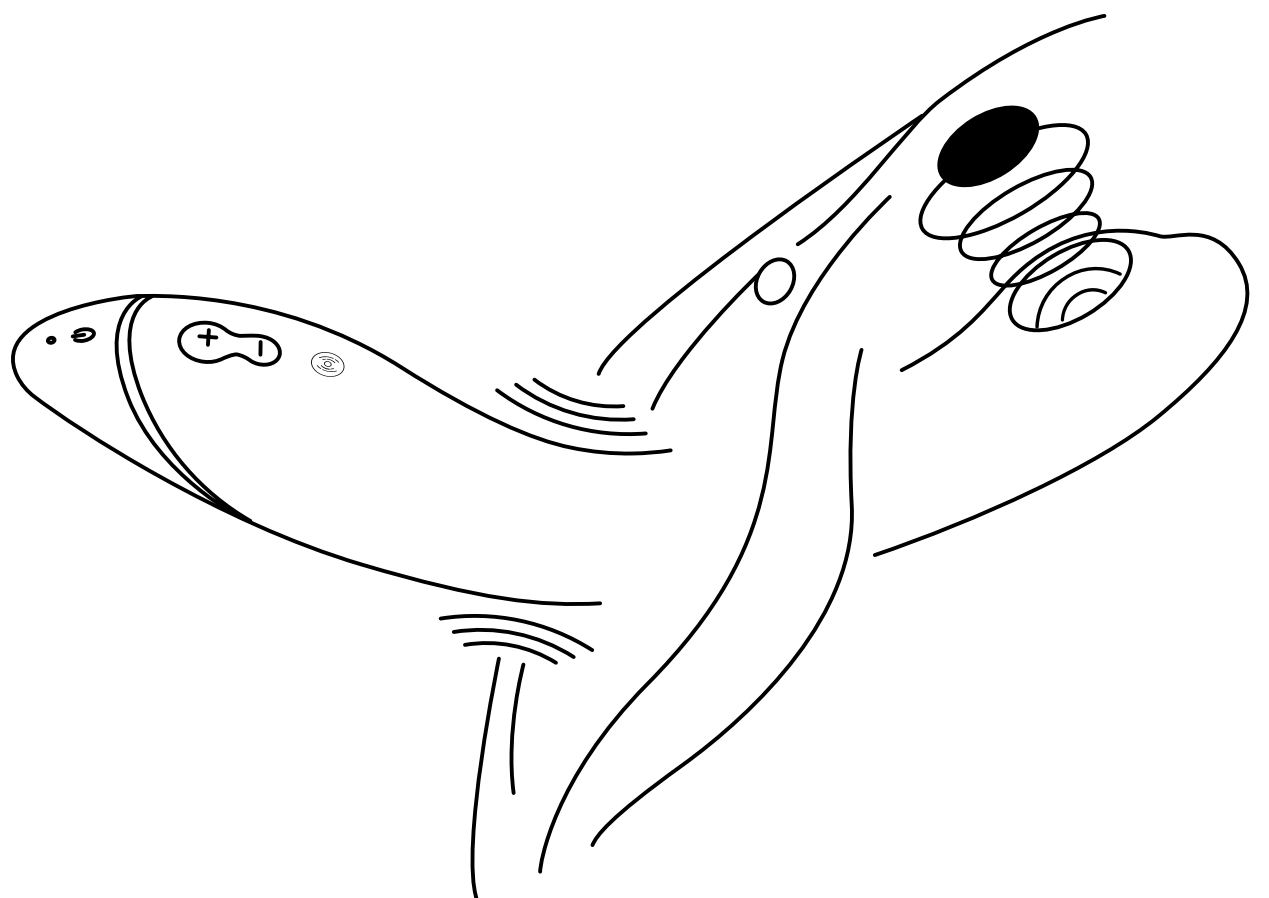
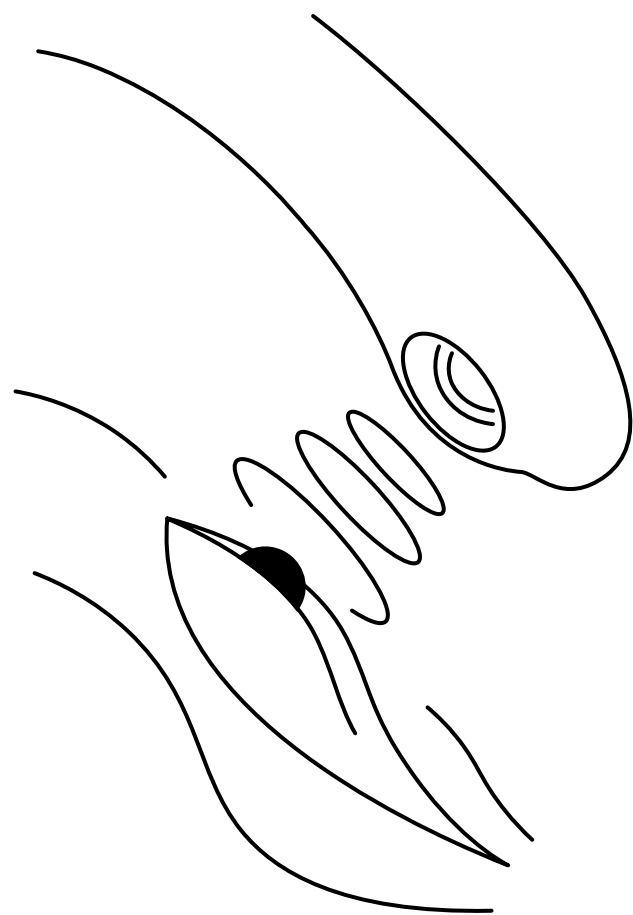

# HVORDAN DEN BRUKES

## 3. Endre intensiteten

**Øk** •  
Trykk kort på  
**12 intensitetsnivåer**

**Øk** •  
Trykk kort på  
**3 vibrasjonsnivåer**

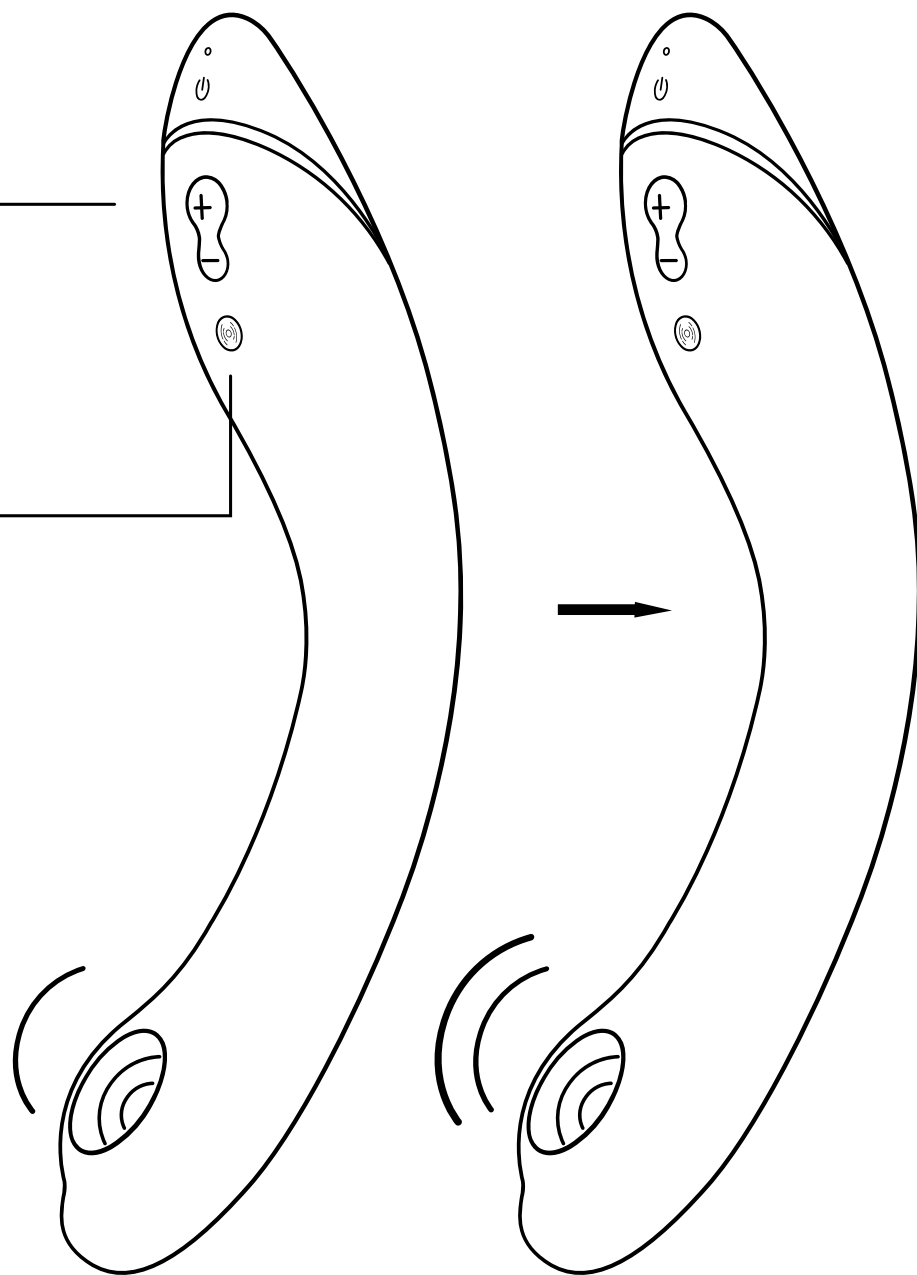

**Reduser** •  
Trykk kort på

**Afterglow**  
Trykk på (-) i ett  
sekund for å gå  
tilbake til  
intensitetsnivå 1

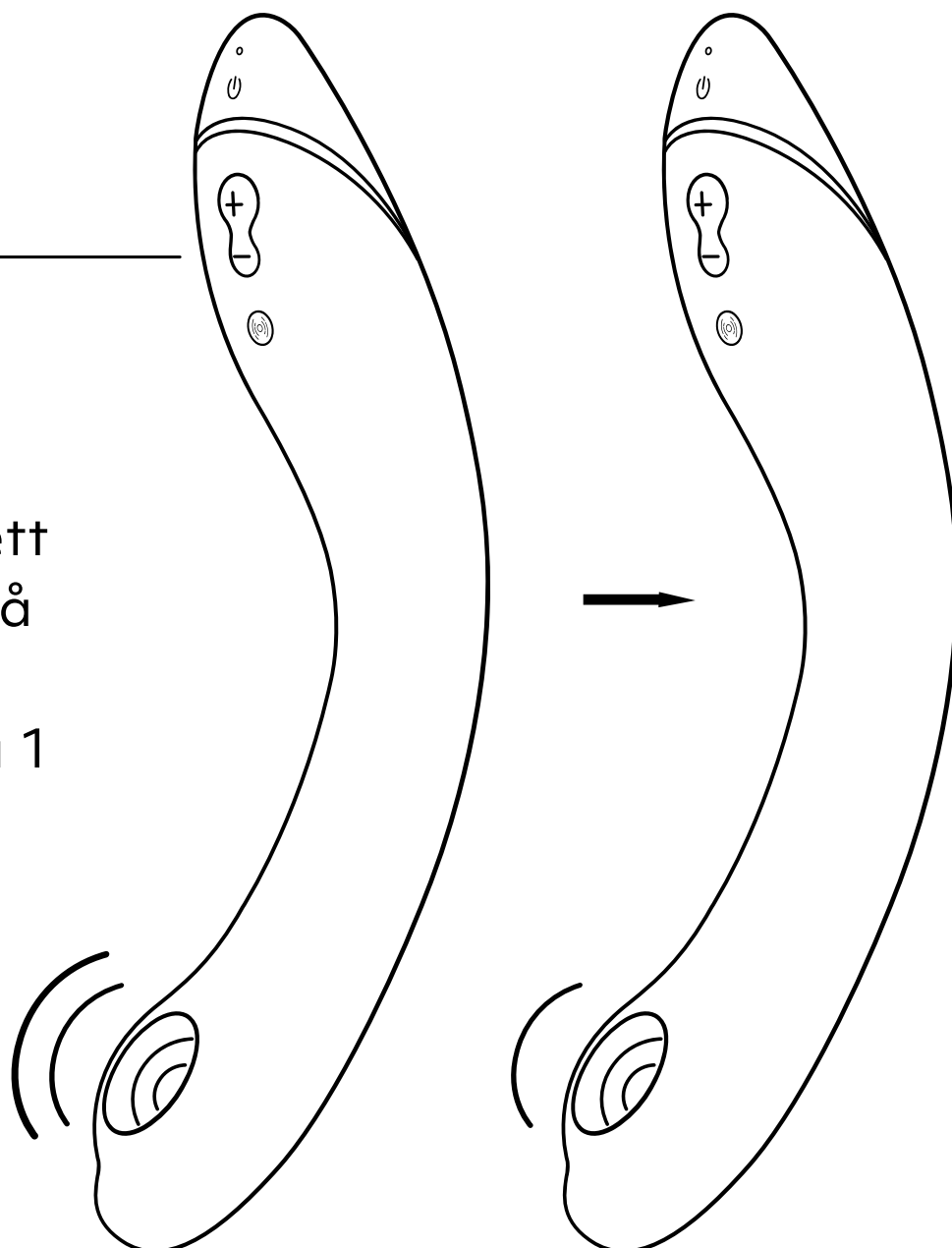



# HVORDAN DEN BRUKES

4. **Slå av** —  
Trykk i 2 sekunder

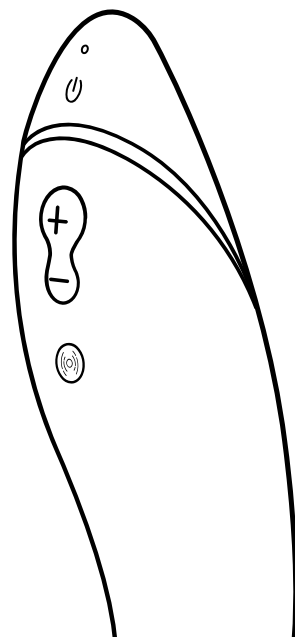

## SMART SILENCE

**OG** skru seg bare på når den nesten berører huden din. Smart Silence skrur på automatisk. Trykk og hold inne pluss- og minusknappene i to sekunder for å skru Smart Silence på eller av.



**Smart Silence På/av**  
Trykk i 2 sekunder

Det kan hende at Smart Silence ikke fungerer når stimuleringshodet er vått. Det er derfor viktig å sørge for å ikke ha glidemiddel inne i Pleasure Air-hodet.

# RENGJØRING

Vask med vann.

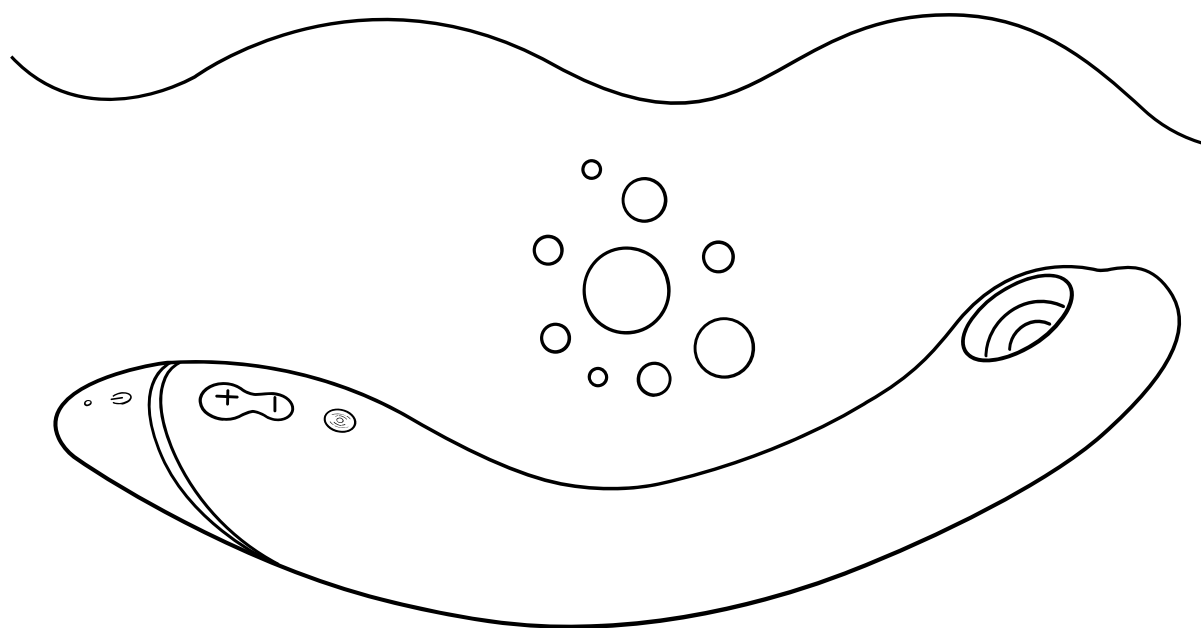

Bruk rengjøringsmiddel for leketøy.

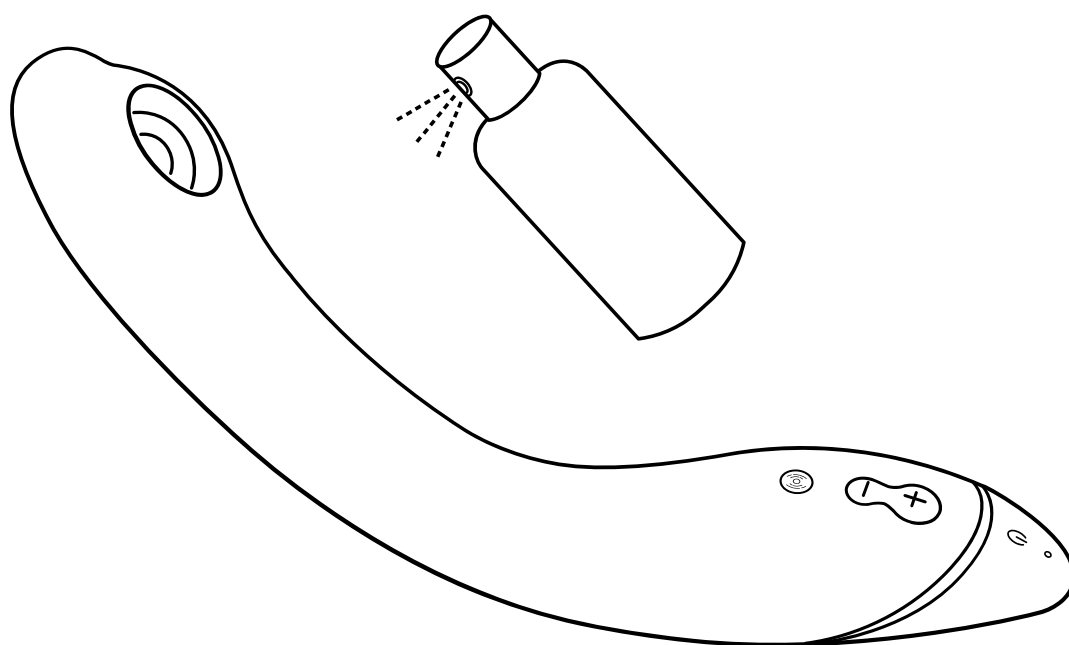

Tørk forsiktig uten å påføre for mye trykk på membranet.

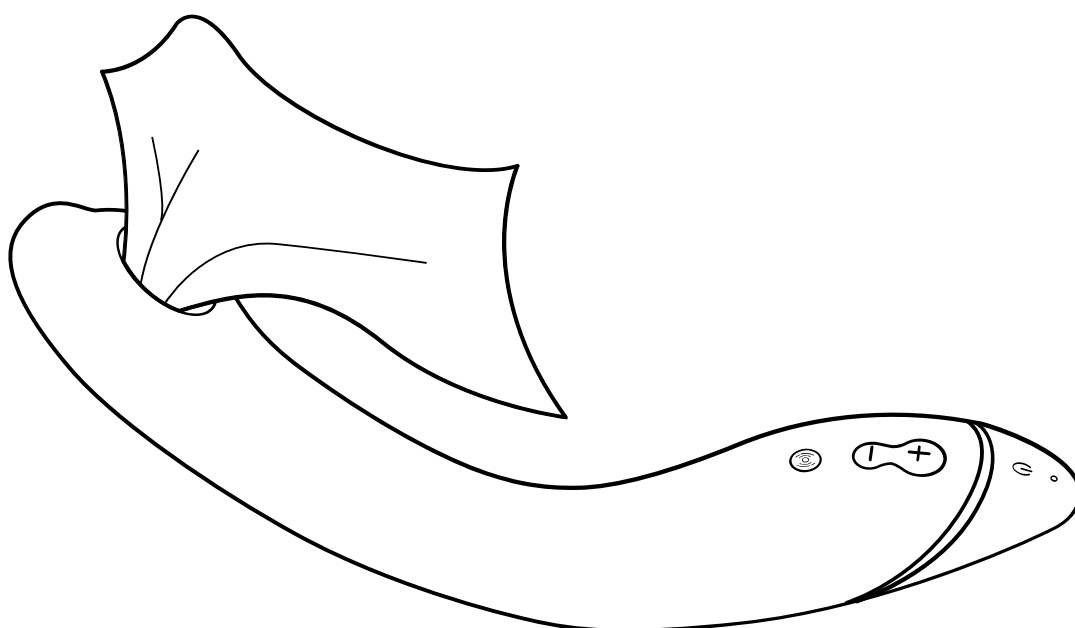

# LADING

Lad opp **OG** før første gangs bruk. Husk også å lade opp **OG** regelmessig, for å sikre lang batterilevetid.

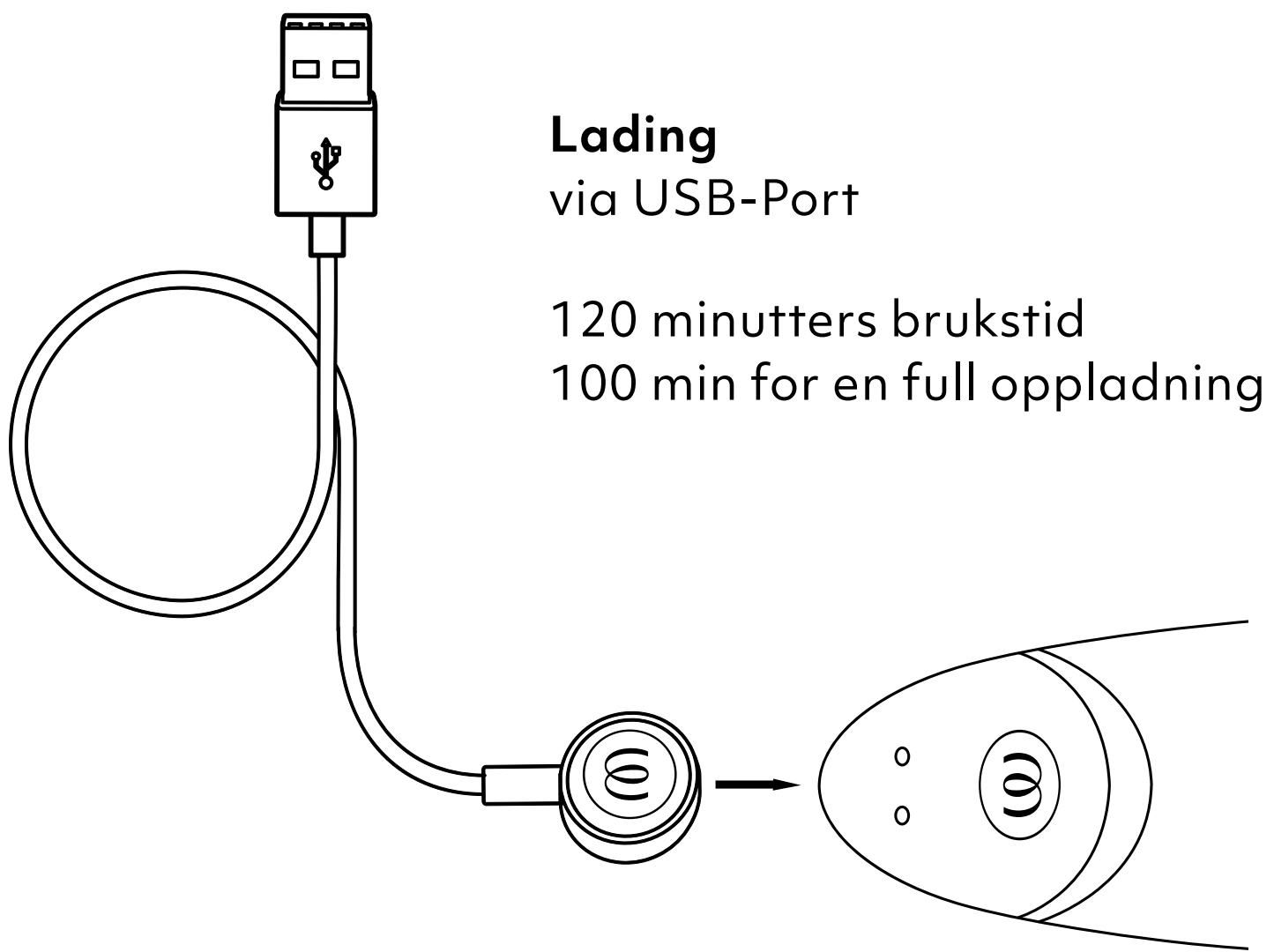

**Lading**  
via USB-Port

120 minutters brukstid  
100 min for en full oppladning

---

**LED**  
På/Av/lading

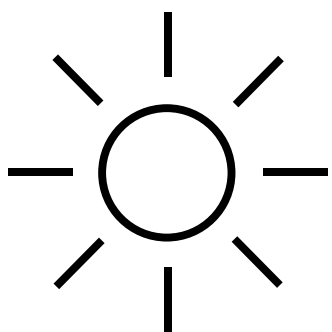

**Fulladet**  
LED-lampen lyser jevnt

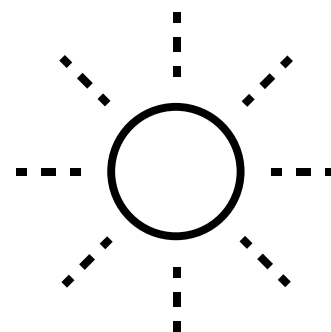

**Lading**  
LED-lampen blinker

# HEMMELIGE TIPS

til hvordan du kan kose deg med  
**WOMANIZER OG**



## G-punktet

«G» i g-punktet kommer av navnet til legen Ernst Gräfenberg. Navnet har blitt værende, men nå vet vi at g-punktet er mindre et «punkt» og mer et større område på indre klitoris, som kan stimuleres fra innsiden av vaginaen.

Dette betyr at g-punktet er dekket av den fremre veggen i vagina. Derfor er det mindre sensitivt enn den ytre, eksponerte klitorisen.

Etttersom det er dekket til, trenger g-punktet litt mer oppvarming. Det blir større, mer sensitivt og mer mottakelig for stimulering med seksuell opphisselse.

En g-punkt-orgasme er en unik opplevelse. Det tar litt tid og energi å oppnå, men det resulterende klimakset er utrolig tilfredsstillende - en helt annerledes opplevelse.

# OPPLEVELSEN

Ta deg god tid, og utforsk deg selv.

Ha vannbasert  
glidemiddel på **OG**.



La deg friste og start med ytre  
Pleasure Air-stimulering.



Bruk så indre Pleasure Air-  
stimulering, kombinert med  
vibrasjoner.



**OG** tilbyr en kombinasjon  
av Pleasure Air-stimulering  
og kraftig vibrering  
- prøv deg frem med  
forskjellige intensiteter og  
Vibrasjonsmodi for en helt  
unik reise mot din orgasme.

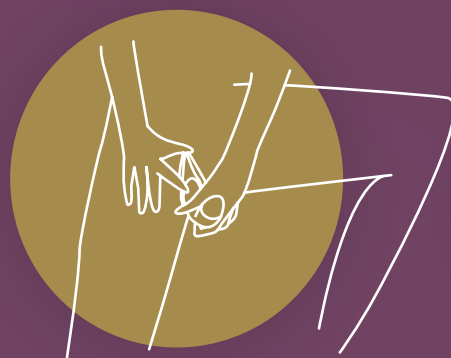
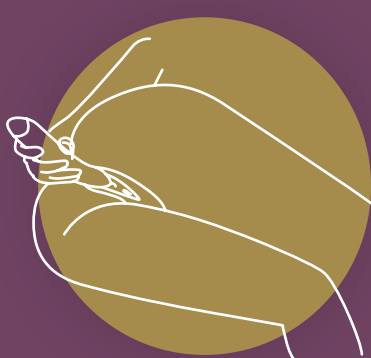

# SAFETY INSTRUCTIONS

## ADVARSEL

Selges kun som et nyhetsprodukt. Produktet skal kun brukes til det tiltenkte formålet. Produktet må oppbevares utilgjengelig for barn. Er ikke egnet for medisinske formål. Dersom du er under legebehandling og/eller har en tilstand som krever bruk av medisinsk utstyr må du spørre legen din før bruk av dette produktet. Stopp bruken av produktet øyeblikkelig, dersom du får irritasjon i huden, smerte eller ubehag og kontakt legen din.

Dette apparatet skal bare brukes av voksne. Personer med nedsatte fysiske, sensoriske eller mentale evner, eller har manglende erfaring og kunnskap, kun hvis de har tilsyn eller fått instruksjon om bruk av apparatet på en sikker måte og har forstått farene som kan oppstå. Barn skal ikke leke med apparatet. Rengjøring og vedlikehold skal ikke utføres av barn. Det skal ikke brukes på hovne eller betente områder i huden.

- Fjern piercinger og smykker i kjønnsområdet før bruk.
- Produktet må alltid rengjøres før og etter bruk i henhold til instruksene i håndboken.
- For å unngå skader på produktet må produktet og batteriet ikke utsettes for temperaturer over 45 °C, demonteres eller skades mekanisk eller elektrisk.
- Deling av sexleketøy kan overføre seksuelle sykdommer. Ikke del sexleketøyene dine med andre brukere, kun med partneren din. Hvis nødvendig, bruk beskyttende midler sammen med partneren din. Ikke bruk leketøy hvis du oppdager sprekker eller ødeleggelser på materialet.
- Dette produktet er ikke laget for anal bruk. Skal ikke brukes analt!
- For å unngå flekker, ikke legg den myke siden av produktet på en absorberende overflate.
- Laderen og leken må kontrolleres regelmessig for skade og enheten må ikke brukes dersom komponenter er skadet.
- Magnetfelt kan påvirke mekaniske og elektroniske komponenter som pacemakere. Ikke bruk enheten direkte over pacemakeren. Kontakt legen din for mer informasjon. Ikke ha kort med magnetstriper (f.eks. kredittkort) i nærheten av enheten, da de kan bli skadet av produktets magneter.
- Dersom leken har en unormal funksjon, slå den av og les delen om hjelp på vårt nettsted.

## LADING

- Før første gangs bruk av ladeenheten må du kontrollere det lokale spenningsnivået siden den lokale nettspenningen ikke kan overstige den maksimale nettspenningen som er oppgitt på ladeenheten.
- Apparatet må kun leveres med ekstra lav spenning som tilsvarer det som er merket på apparatet.
- Ikke bruk eller rengjør produktet mens batteriet lades.
- Senk aldri ladeenheten eller ladekabelen i vann eller andre væsker.
- Dette apparatet inneholder batterier som ikke kan byttes.
- Dette produktet inneholder et oppladbart li-ion-batteri.
- Koble ladekabelen fra strømforsyningen etter hver ladeprosess.

## FØLG FØLGENDE RETNINGSLINJER FOR OPTIMAL BRUK AV PRODUKTET:

- For å sikre lang levetid for batteriet må enheten lades regelmessig, selv om den ikke brukes.
- Oppbevares på et sikkert, tørt sted uten eksponering for direkte sollys.
- Vi anbefaler å bruke et vannbasert glidemiddel med leken din. Ikke bruk glidemiddel, geleer eller massasjeoljer som er basert på silikon eller alkohol for å unngå skade.

# GENERAL INFORMATION

## ELECTRICAL RATING

**Model:** OG

**Model No.:** TES10A

**Power Input:**

3,7 V=0,62 A: Built-in Li-Polymer rechargeable battery.

5 V=0,5 A: When charged using USB.

Use USB AC adaptor (not included) with power output corresponding to product rating. Use original provided cable only."

## CONTENT OF DELIVERY

Womanizer OG G-Spot vibrator, USB charging cable (AC adapter not included), cotton storage pouch, quick start guide, safety instructions

## ENVIRONMENTAL PROTECTION

As a distributor of electronic devices, we are legally obliged to accept the return of waste electrical and electronic devices free of charge. We expressly state that you as the user are legally obliged to return used batteries.

Never throw away electronic devices or batteries in the household waste. The symbol shown below (crossed-out wheeled bin) is intended to expressly remind you of this.

## MANUFACTURED AND DISTRIBUTED BY

**WOW Tech Europe GmbH**

Hermann-Blankenstein-Strasse 5

10249 Berlin

[www.wowtech.com](http://www.wowtech.com)

WOW Tech Europe GmbH reserves the right to make technical changes and changes to the design that serve to improve the device.

For information regarding patents see [womanizer.com/patents](http://womanizer.com/patents).

## CUSTOMER CARE

[care@womanizer.com](mailto:care@womanizer.com)

[womanizer.com](http://womanizer.com)

Designed in Germany. Made in China.

Date of issue: 10/2022.





# ØNSKER DU MER?

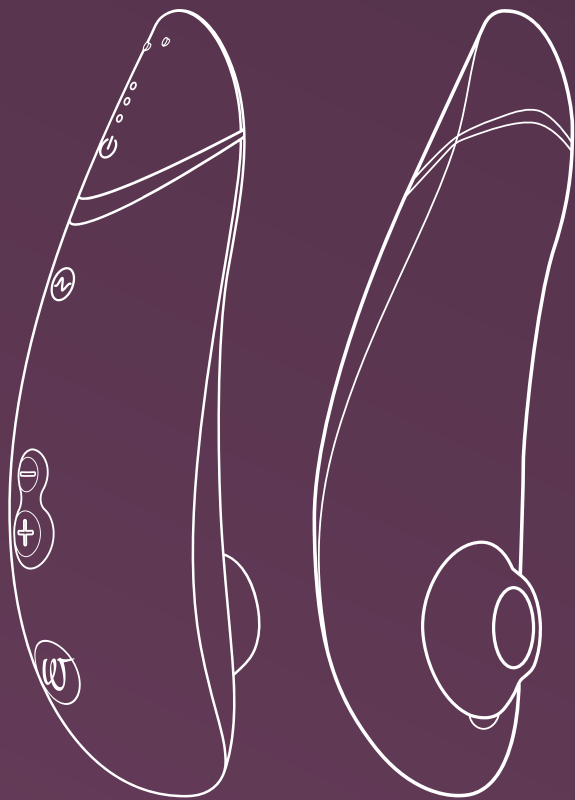

Pleasure Air  
Technology

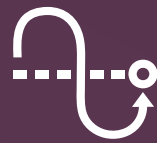

Autopilot



Smart Silence

**Premium 2**  
Define your luxury

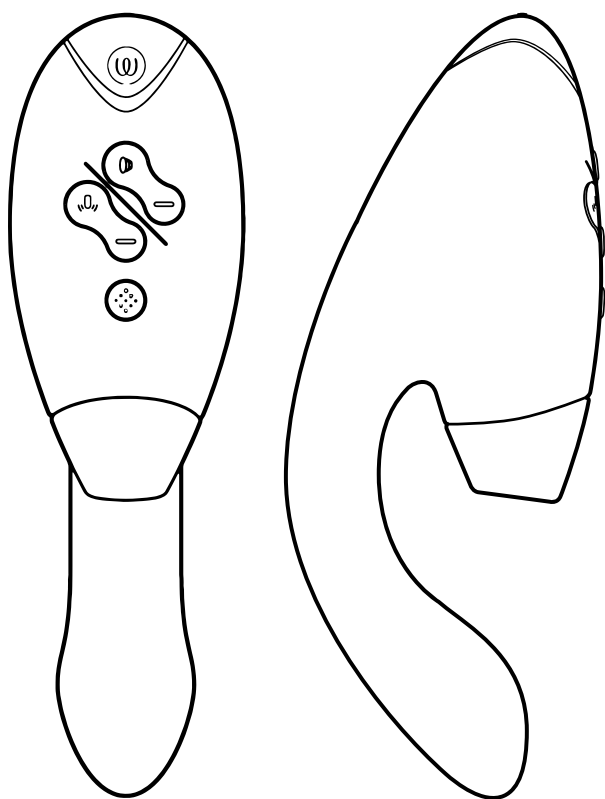

Pleasure Air  
Technology



Double Stimulation



Smart Silence

**DUO 2**  
Indulge in whole-body orgasms





#IMASTURBATE

# Hi!

感谢您选购 **WOMANIZER**

欢迎来到一个充满感官体验的世界,这将让您的生活更加丰富多彩。选择 **WOMANIZER**,您不仅可以获得无可比拟的高潮,还可以体验从未有过的愉悦之情。

享受 **WOMANIZER** 带来的高潮快感。

开始享受吧,关爱自己!



描述

如何使用

SMART SILENCE

清洁

充电

SAFETY INSTRUCTIONS

一般信息

Please read the safety instructions in the  
Compliance & Safety Information before first use.

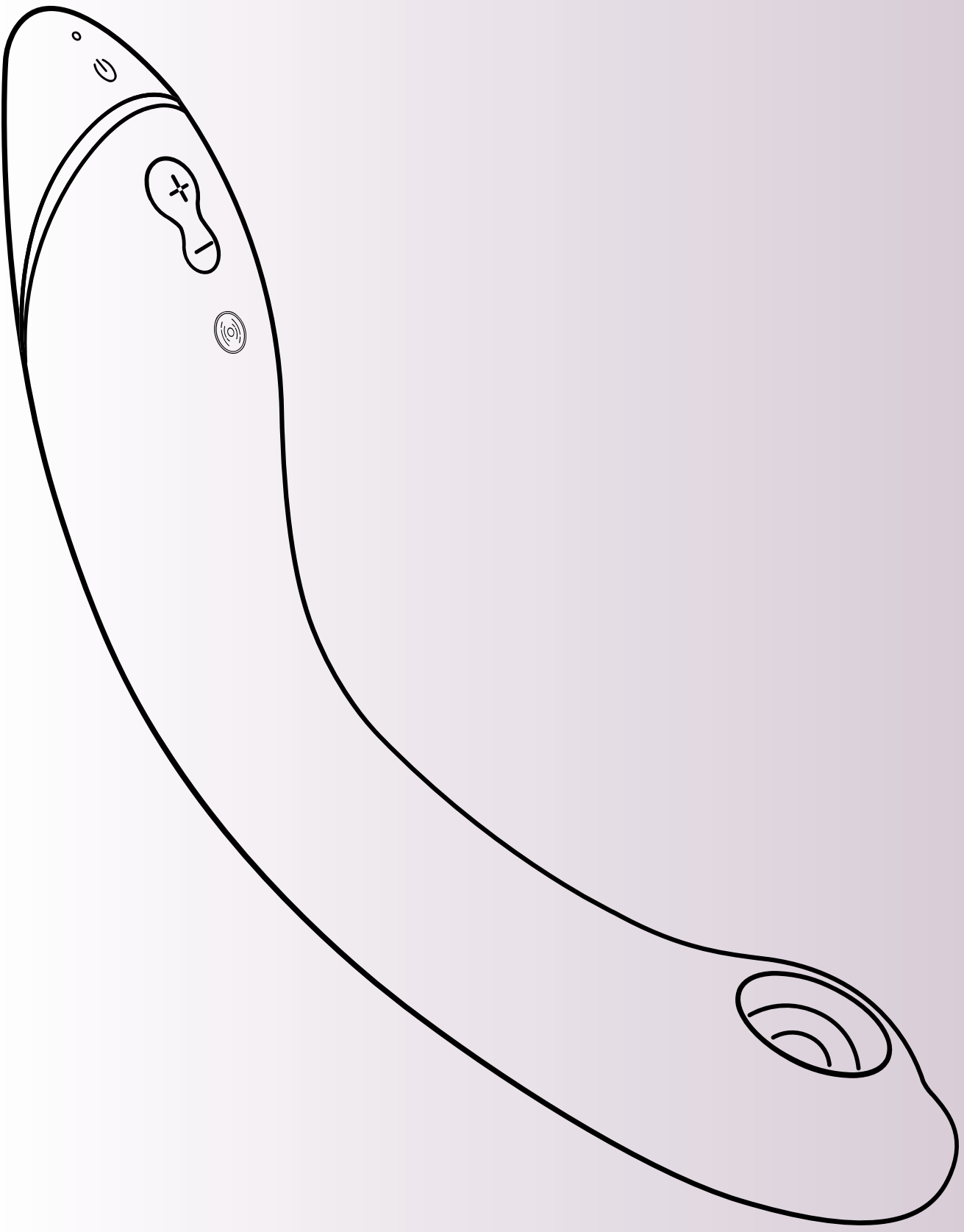

# 说明

**LED 显示屏**  
开机/充电

**开启/关闭  
Smart Silence**  
按住 2 秒

**震动**  
按一下即可启动并增  
加强度

**Pleasure Air Technology**  
12 档强度

**开/关**  
按住 2 秒

**增加强度**  
按一下 (+) 键

**降低强度**  
按一下 (-) 键

**Afterglow**  
按住 (-) 1 秒



# 如何使用

## 1. 开机

按住 2 秒

LED 灯将指示该产品已启动。

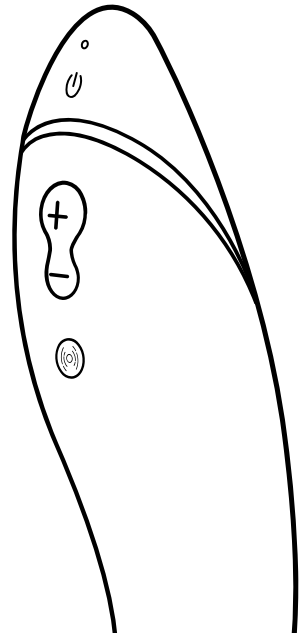

## 2. 使用

要想激发“性致”，  
可以先在阴蒂上使用 **OG**。

在 **OG** 的主体上添加水溶性润滑油。

在 **OG** 的主体上添加水溶性润滑油。

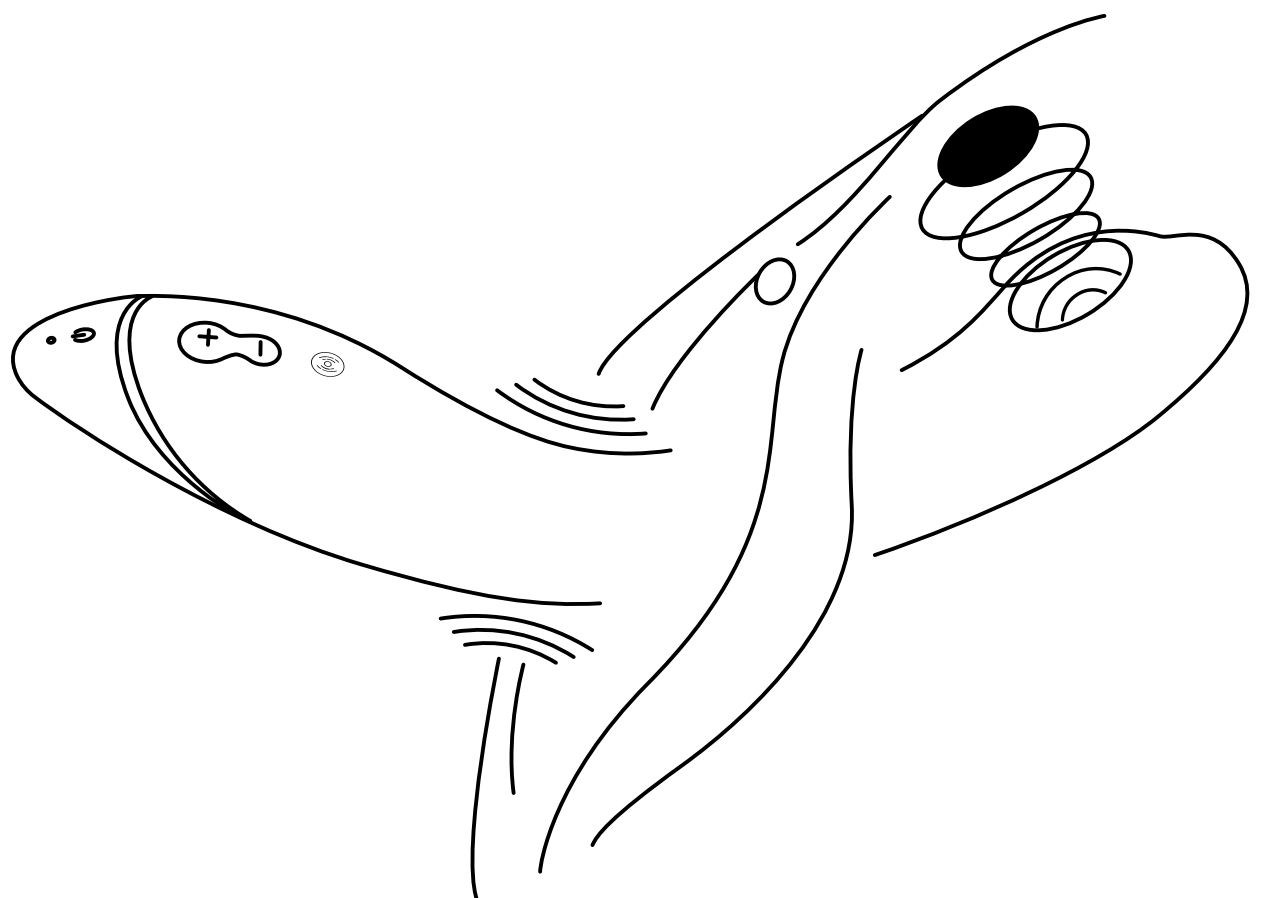

# 如何使用

## 3. 改变强度

**增强** •  
按一下即可  
**12 档强度**

**增强** •  
按一下即可  
**3 个振动等级**

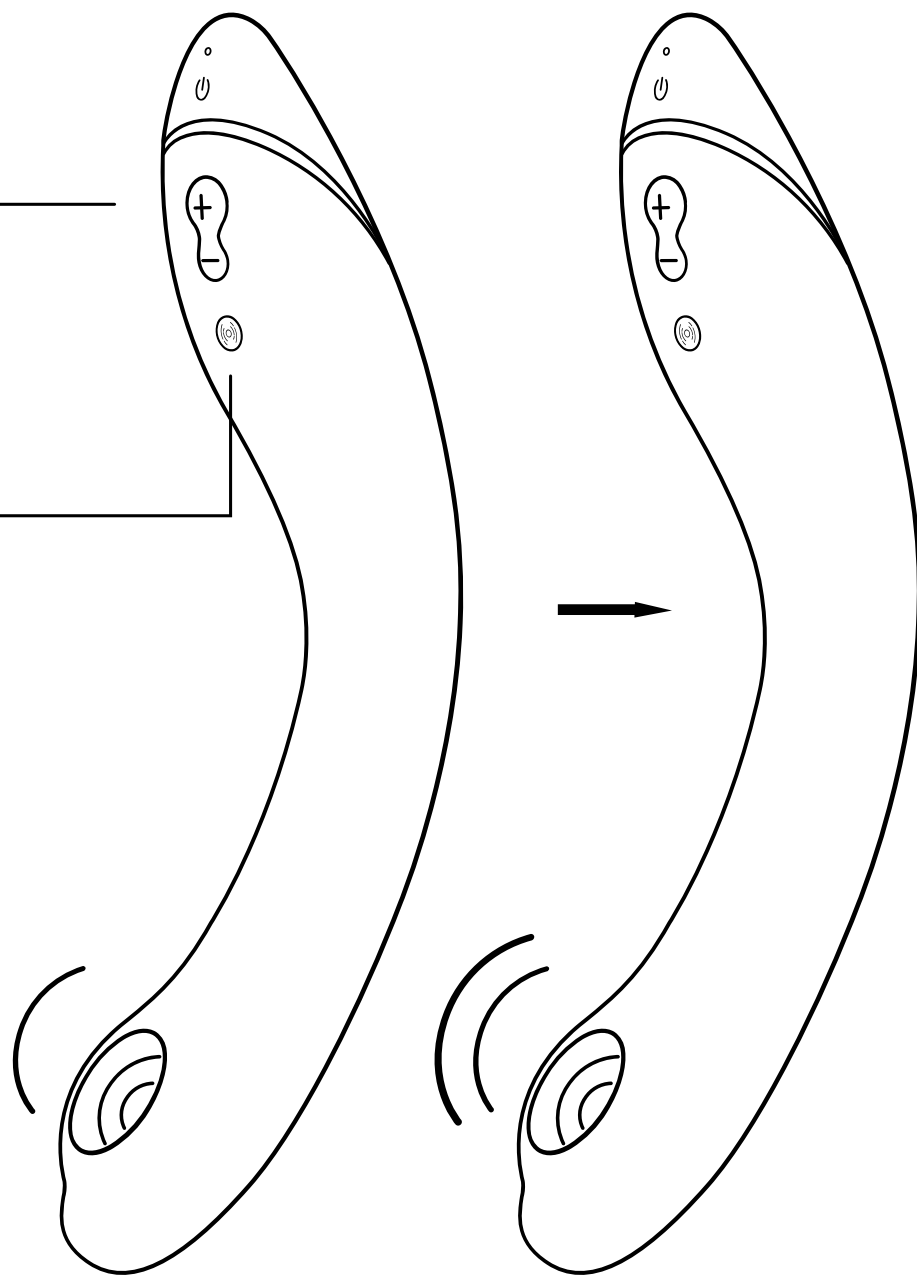

**降低** •  
按一下即可

**Afterglow**  
按 (-) 1 秒, 回到 1 档强度。

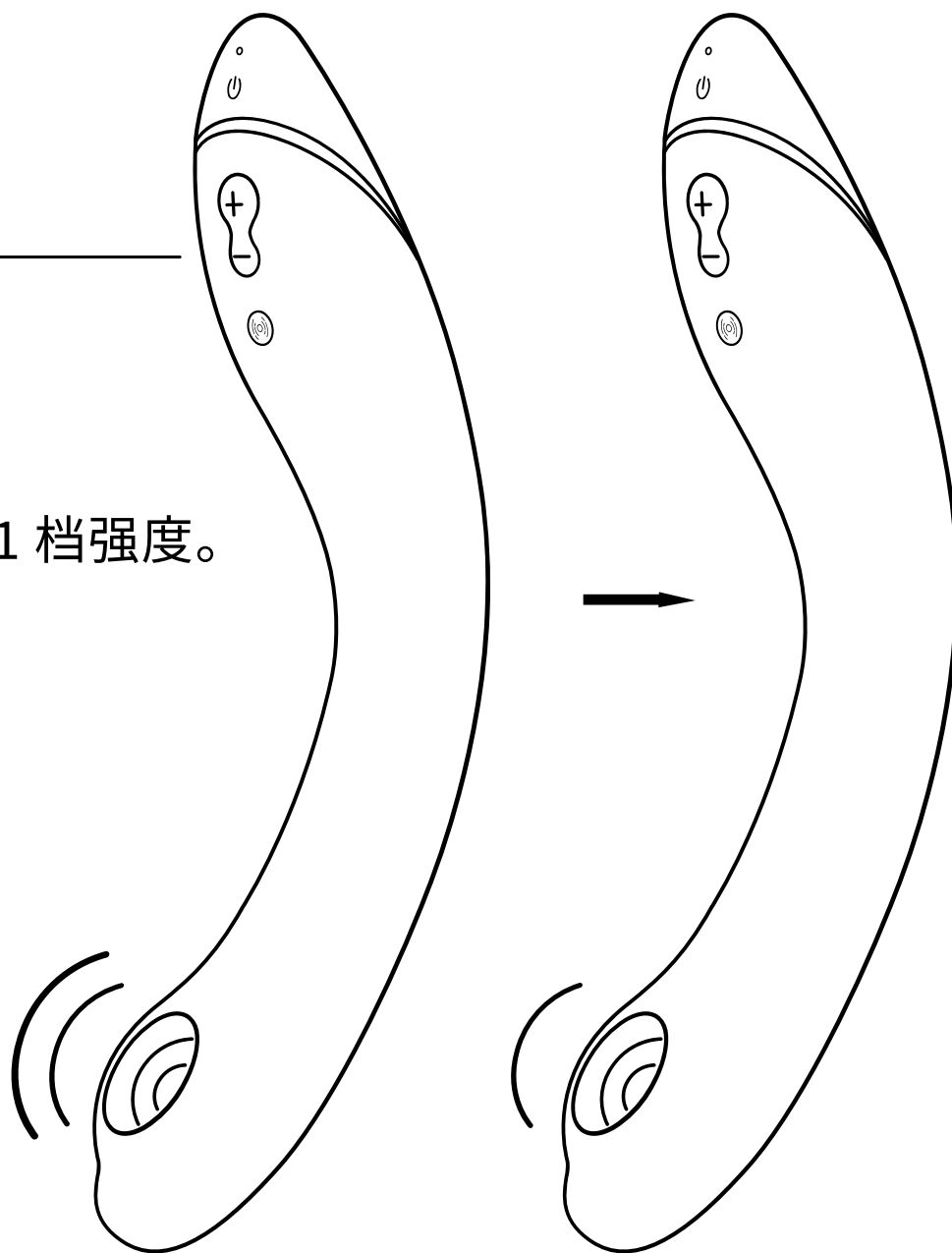

# 如何使用

4. 关机  
按住 2 秒

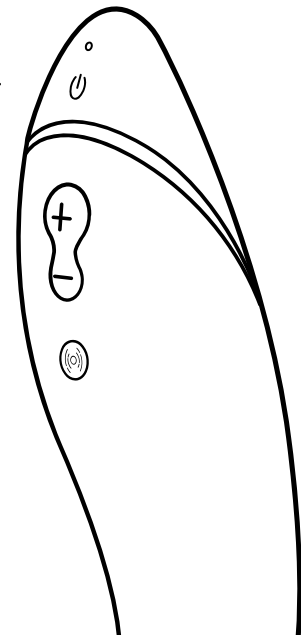

## SMART SILENCE

**OG** 仅在几乎接触到您的皮肤时才会打开。Smart Silence 默认开启。按住加号和减号按钮 2 秒钟即可打开或关闭 Smart Silence。



**Smart Silence 开/关**  
按住 2 秒

吸吮潮湿时, Smart Silence 功能可能无法工作。因此, 请确保不要将润滑油涂抹在 Pleasure Air 的头部。



# 清洁

水洗。

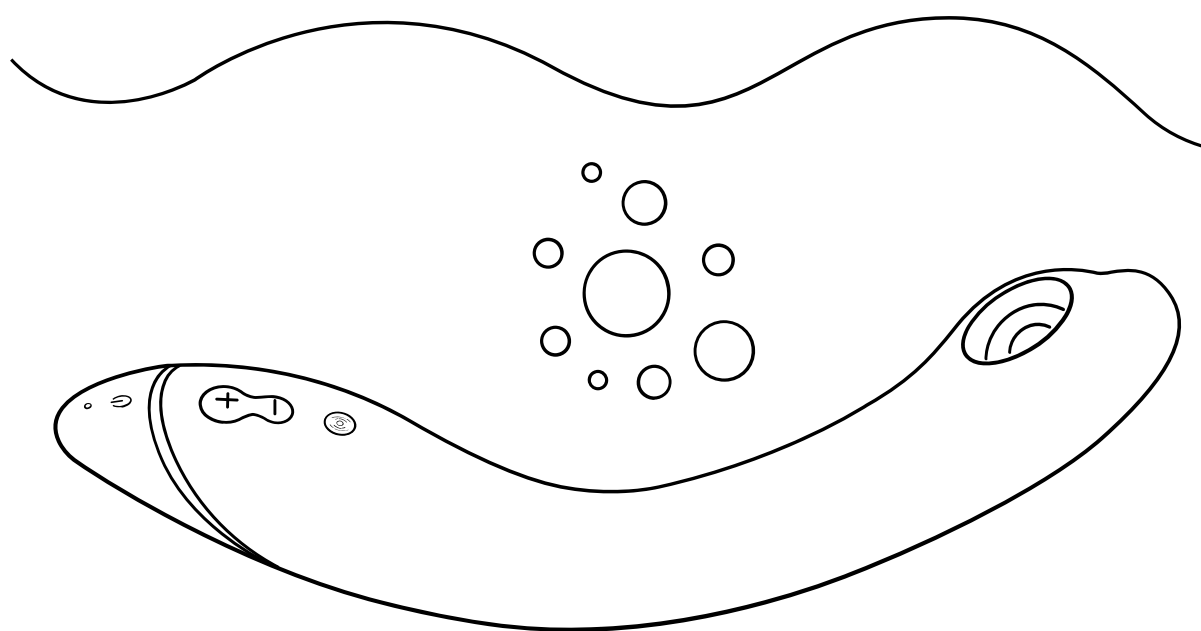

使用玩具清洁剂。

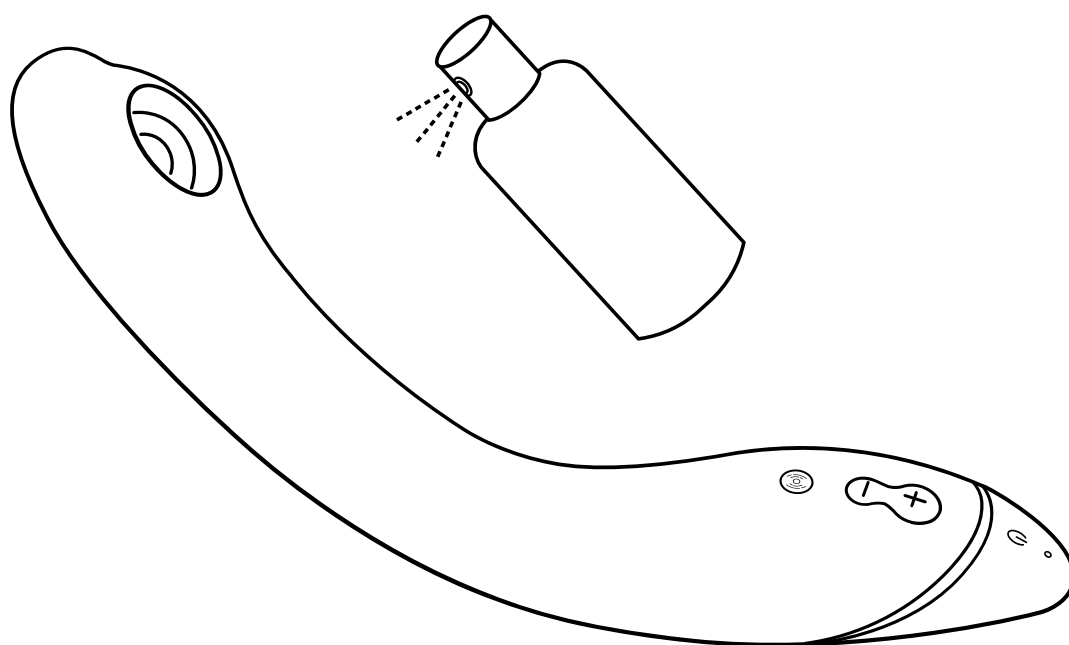

小心干燥，不要对薄膜施加太大压力。

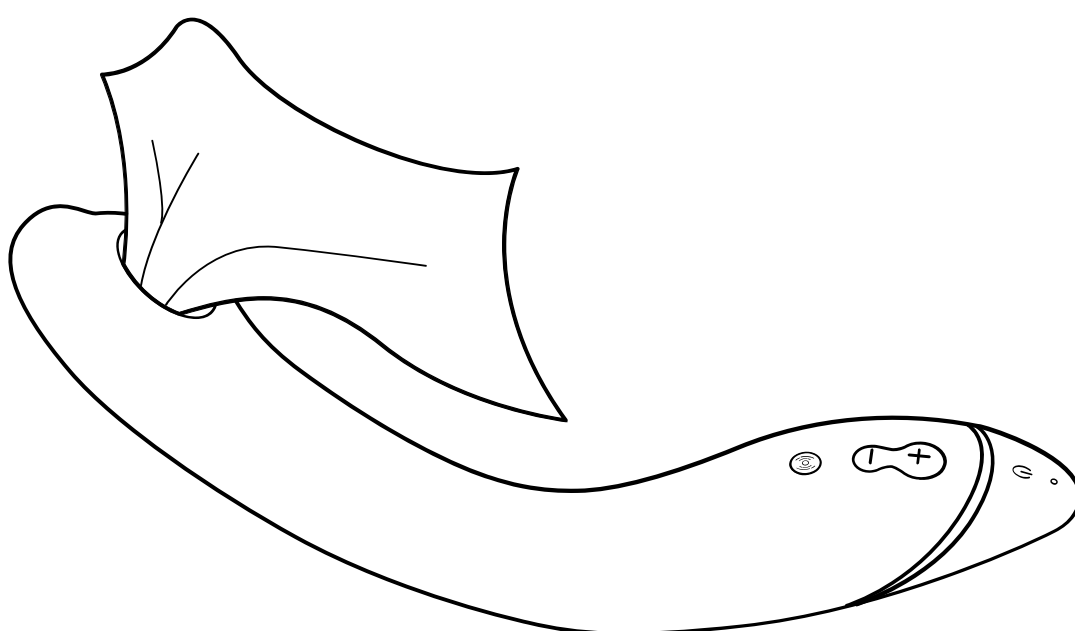

防水 (IPX7)

# 充电

请在首次使用前为您的 **OG** 充电。同时也不要忘记  
定期为您的 **OG** 充电, 确保电池使用寿命。

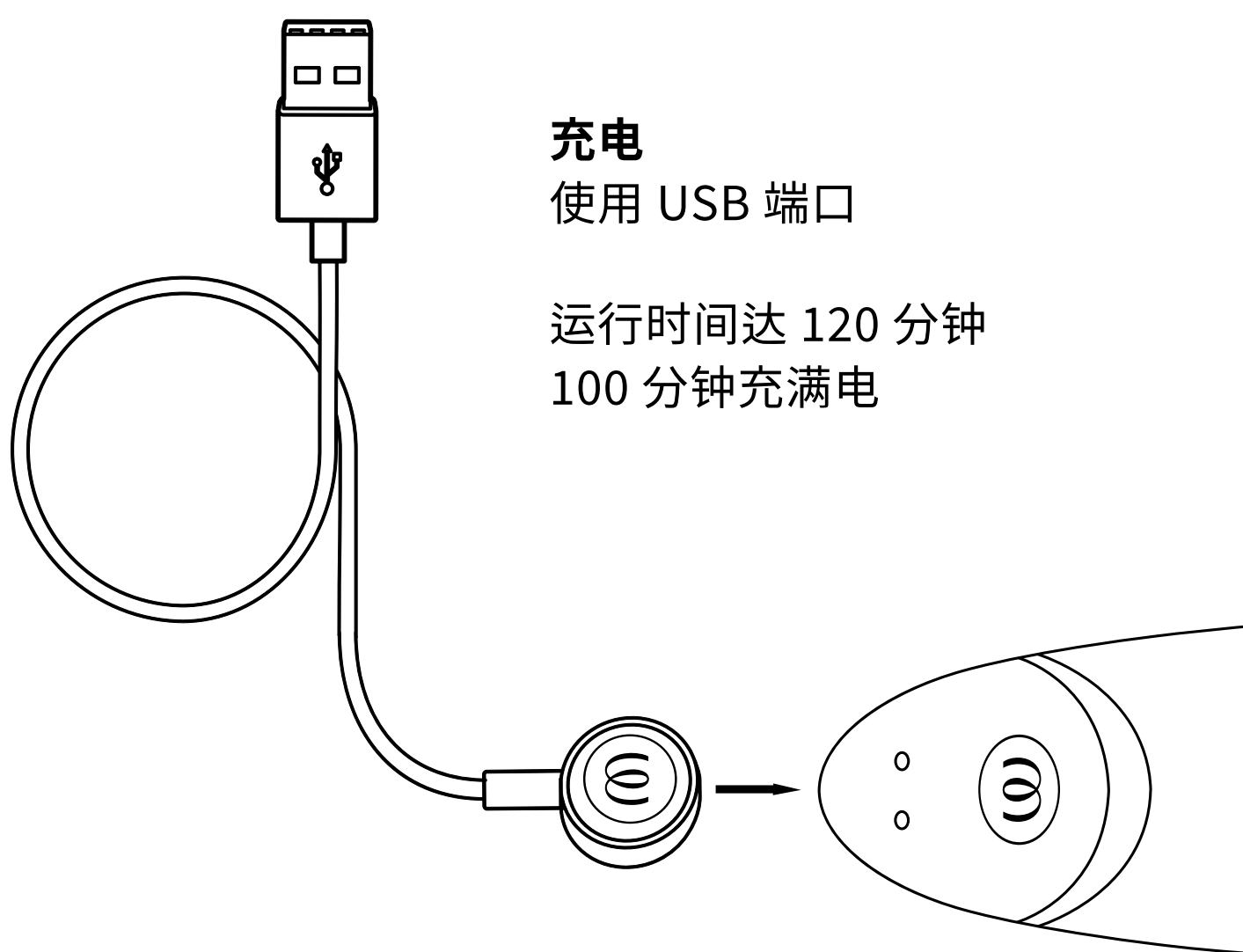

**充电**  
使用 USB 端口

运行时间达 120 分钟  
100 分钟充满电

---

**LED 灯**  
开/关/充电

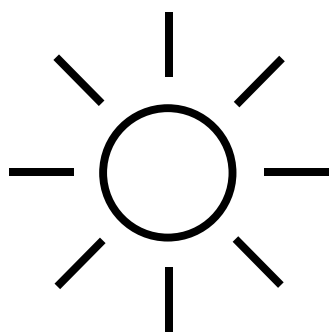

**已经充满电**  
LED 灯持续亮

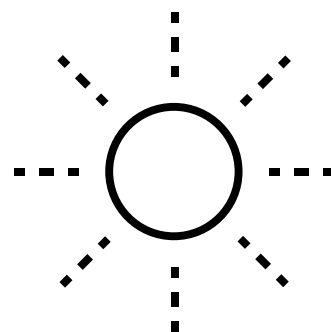

**充电**  
LED 灯闪烁

# SAFETY INFORMATION

## 警告

仅以新品出售。仅将本产品用于预定用途。请勿让儿童接触产品。不适合医疗目的使用。如果您正接受医生照护和/或存在需要使用任何医疗设备的情况,请在使用本产品之前咨询您的医生。如果您感到任何皮肤刺激、疼痛或不适,请立即停止使用该产品,并咨询医生。

本设备仅供成年人使用。生理、感官或心智受限人士,或者经验和/或知识不足者,在有人监督,或者经过设备安全使用方法指导并了解相关危险后,亦允许使用。儿童不得玩耍本产品。清洁和用户维护不应由儿童进行。请勿用于皮肤肿胀或发炎区域。

- 使用前,请去除生殖器部位的穿孔或珠宝。
- 在使用前后,请务必按照手册中的说明清洁产品。
- 为避免产品损坏,请勿将产品及其电池暴露在温度高于45°C的环境、对其进行拆卸,或使其受到机械或电气损坏。
- 共享性爱玩具可能会传染性疾病。除伴侣之外,请勿与其他用户分享您的性爱玩具。与您的伴侣共享时,如有需要,请使用防护措施。如果发现包覆材料有裂纹或剥落迹象,请勿使用玩具。
- 本产品不适用于肛门内。请勿插入肛门!
- 请勿将产品柔软的一边置于吸水表面之上,以避免造成污渍。
- 定期检查充电设备和产品是否损坏,如果任何零件出现损坏,请勿使用设备。
- 磁场会影响机械和电子零件,例如心脏起搏器。请勿在起搏器上方直接使用设备。有关更多信息,请与您的医生联系。请勿将带有磁条的卡(例如信用卡)放在设备附近,因为产品上的磁铁可能会损坏这些卡片。
- 如果您怀疑玩具出现功能异常,请关闭电源并咨询我们网站上的技术支持。

## 充电中

- 第一次使用充电设备之前,请检查当地电压,因为当地电源电压不得超过本充电设备规定的最大电源电压。
- 本设备必须仅根据设备上的标记使用安全特低电压供电。
- 电池充电时请勿使用或清洁产品。
- 切勿将充电设备或充电线浸入水或其他液体中,或用水或其他液体冲洗。
- 本设备随附不可更换电池。
- 本产品附带一个可充电的锂离子电池。
- 每次充电后,请断开充电电缆与电路的连接。

## 为确保最佳使用产品,请遵循以下准则:

- 为延长电池寿命,即使不使用设备,也请定期为设备充电。
- 存放在安全、干燥的地点,避免阳光直射。
- 我们建议您在玩玩具时搭配水性润滑剂。请勿使用含香精、硅性或含酒精的润滑油、凝胶或按摩精油,以免造成损坏。

# GENERAL INFORMATION

## ELECTRICAL RATING

**Model:** OG

**Model No.:** TES10A

**Power Input:**

3,7 V=0,62 A: Built-in Li-Polymer rechargeable battery.

5 V=0,5 A: When charged using USB.

Use USB AC adaptor (not included) with power output corresponding to product rating. Use original provided cable only."

## CONTENT OF DELIVERY

Womanizer OG G-Spot vibrator, USB charging cable (AC adapter not included), cotton storage pouch, quick start guide, safety instructions

## ENVIRONMENTAL PROTECTION

As a distributor of electronic devices, we are legally obliged to accept the return of waste electrical and electronic devices free of charge. We expressly state that you as the user are legally obliged to return used batteries.

Never throw away electronic devices or batteries in the household waste. The symbol shown below (crossed-out wheeled bin) is intended to expressly remind you of this.

## MANUFACTURED AND DISTRIBUTED BY

**WOW Tech Europe GmbH**

Hermann-Blankenstein-Strasse 5

10249 Berlin

[www.wowtech.com](http://www.wowtech.com)

WOW Tech Europe GmbH reserves the right to make technical changes and changes to the design that serve to improve the device.

For information regarding patents see [womanizer.com/patents](http://womanizer.com/patents).

## CUSTOMER CARE

[care@womanizer.com](mailto:care@womanizer.com)

[womanizer.com](http://womanizer.com)

Designed in Germany. Made in China.

Date of issue: 10/2022.



还想要更多？

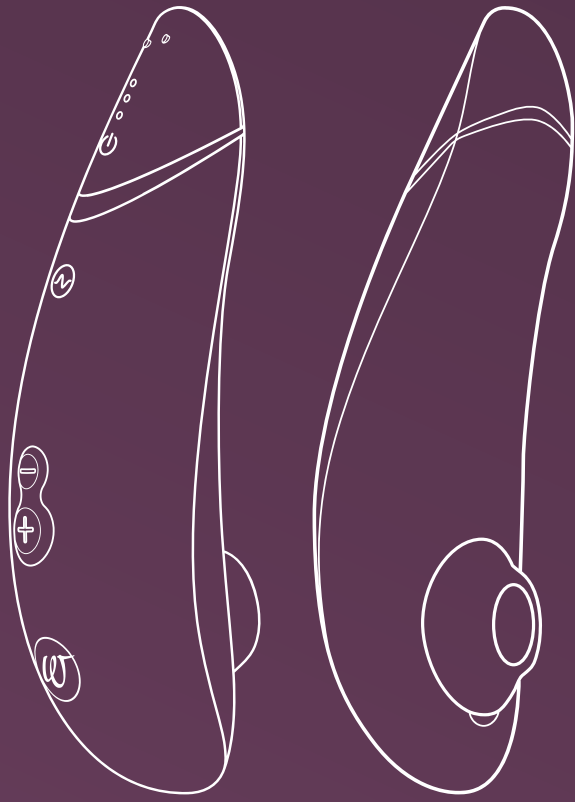

Pleasure Air  
Technology

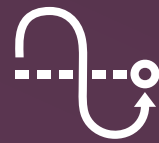

Autopilot



Smart Silence

**Premium 2**  
Define your luxury

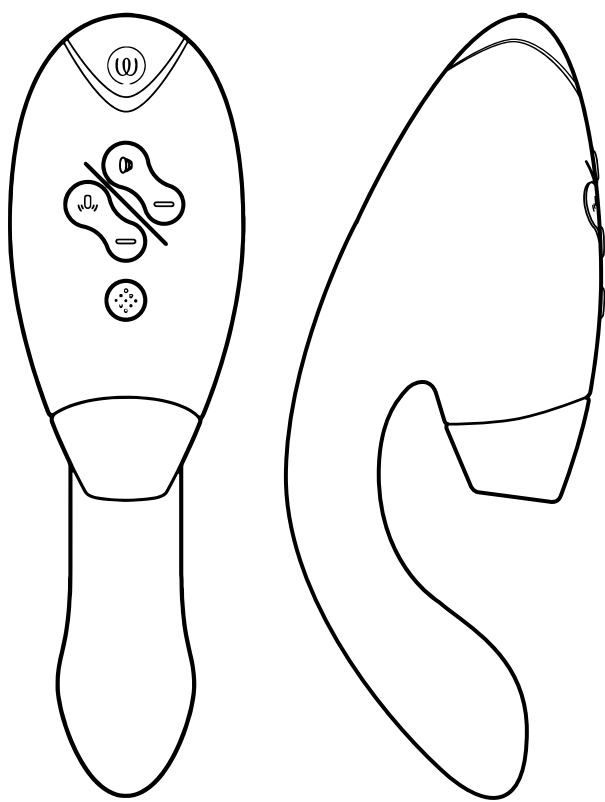

Pleasure Air  
Technology



Double Stimulation

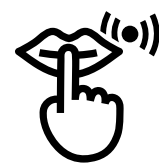

Smart Silence

**DUO 2**  
Indulge in whole-body orgasms



#IMASTURBATE

# Hi!

**WOMANIZER**를 선택해주셔서 감사합니다

삶을 윤택하게 해주는 섹시한 경험이 가득한 세계에 오신 것을 환영합니다. **WOMANIZER**를 선택하신 여러분은 차원이 다른 오르가즘으로, 완전히 새로운 즐거움을 느끼실 수 있을 거예요.

**WOMANIZER**로 오르가즘을 연달아 즐기세요.

자, 스스로를 사랑하러 가요!



설명

사용 방법

SMART SILENCE

세척

충전

WOMANIZER OG를 최대한 즐길  
수 있는 상세한 꿀팁

SAFETY INSTRUCTIONS

일반 정보

Please read the safety instructions in the  
Compliance & Safety Information before first use.



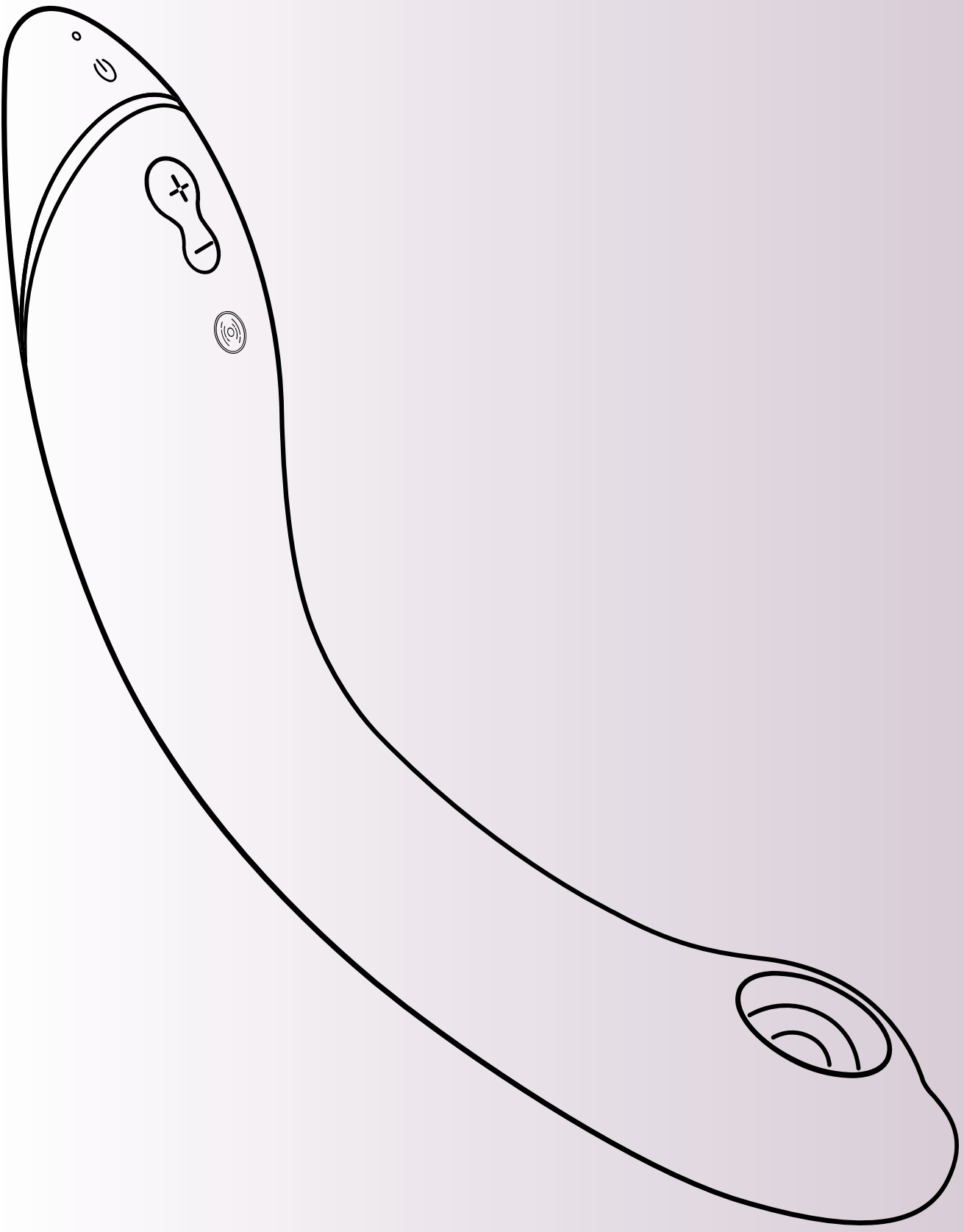

# 설명

LED 표시등  
On/충전 중

Smart Silence  
켜기/끄기  
2초간 누르기

진동  
짧게 눌러 활성화, 강도  
높이기

Pleasure Air Technology  
12단계 강도 조절

On/Off  
2초간 누르기

강도 높이기  
(+) 짧게 누르기

강도 낮추기  
(-) 짧게 누르기

Afterglow  
(-) 1초간 누르기



# 사용 방법

## 1. 전원 켜기

2초간 누르기

LED가 켜져 제품이 켜졌음을 알려줍니다.

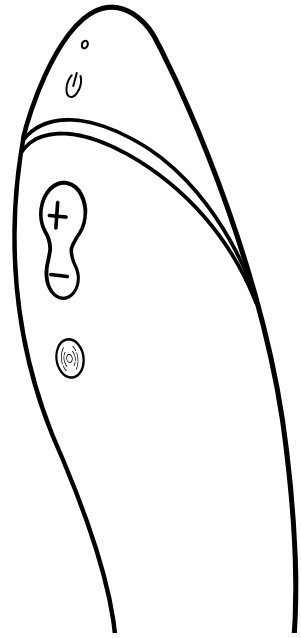

## 2. 사용하기

적당한 자세에서 먼저,  
클리토리스에 **OG**를 사용합니다.

**OG** 표면에 수성 윤활제를  
바릅니다.

몸이 달궈졌으면 **OG**를 삽입하여 G  
스팟을 찾아봅니다!

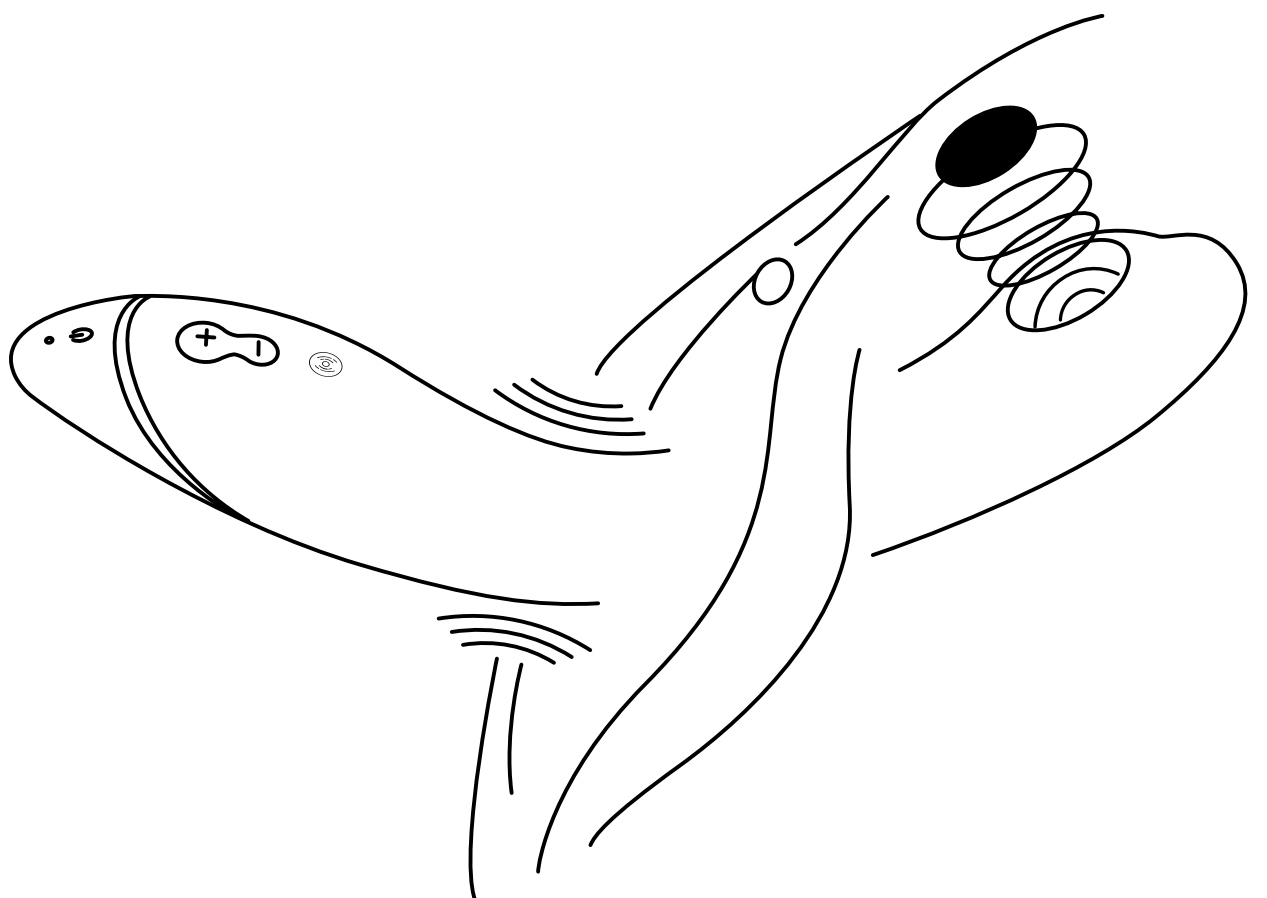
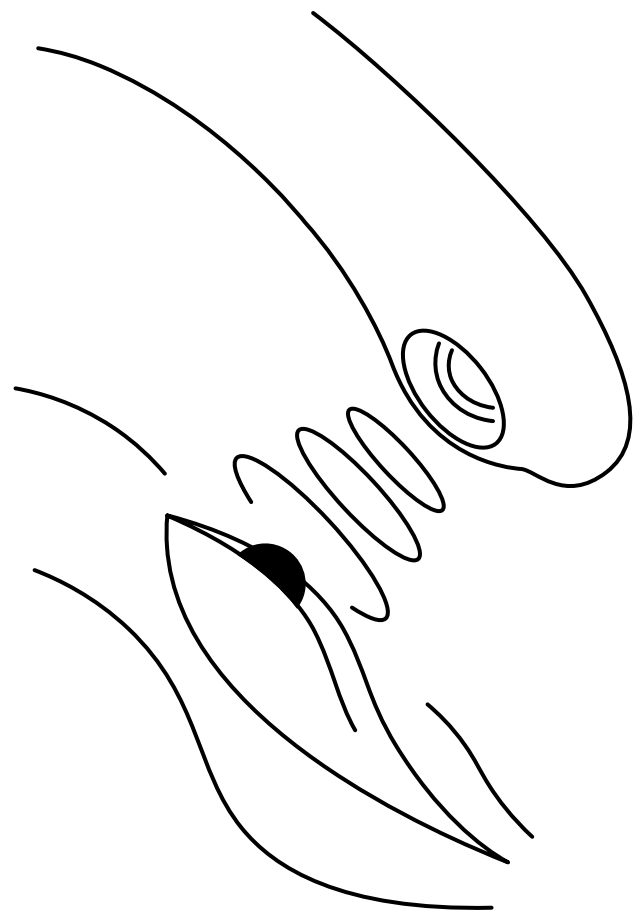

# 사용 방법

## 3. 강도 변경

높이기 •  
짧게 누르기  
12단계 강도 조절

높이기 •  
짧게 누르기  
3단계 진동 조절

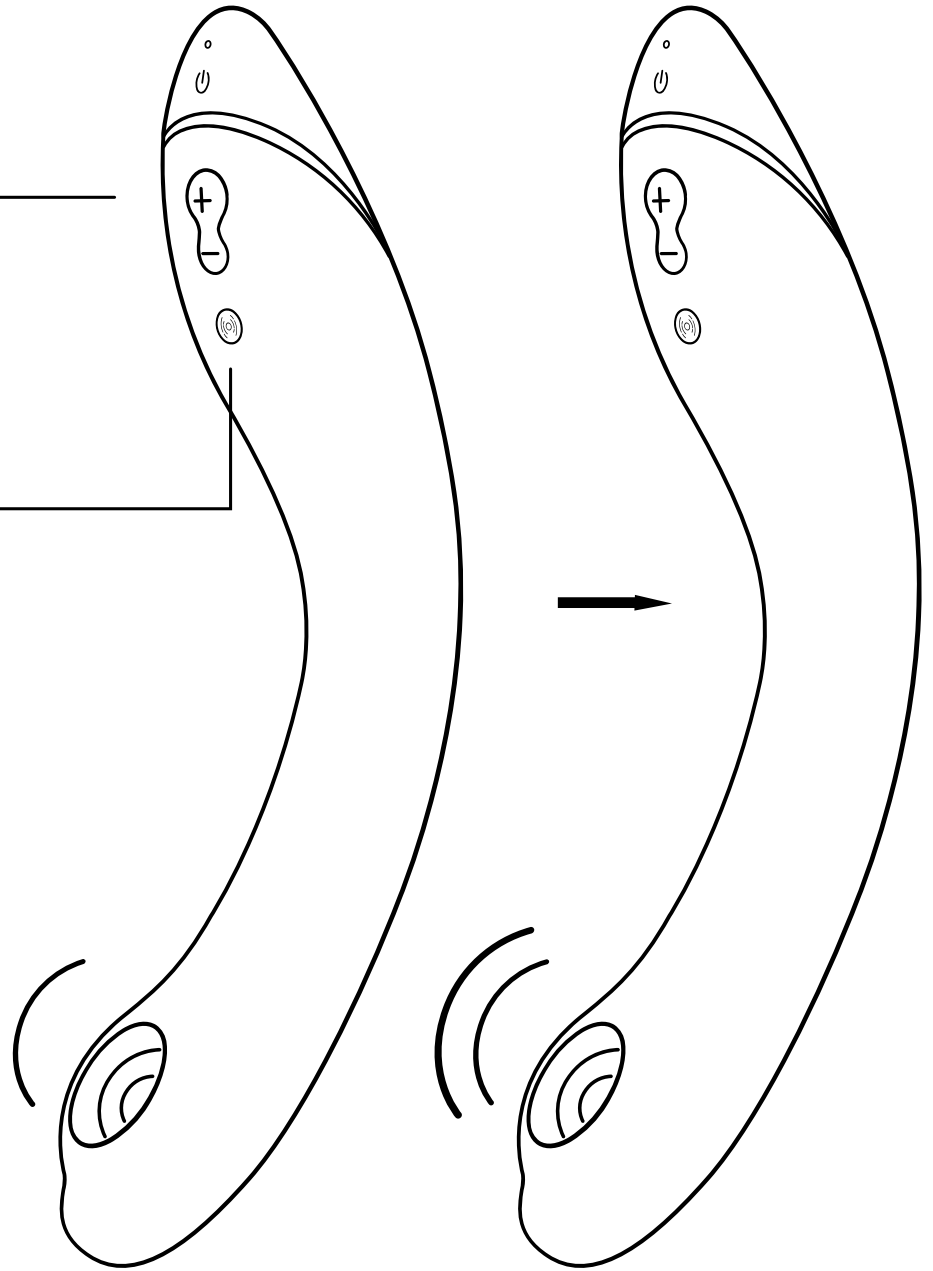

낮추기 •  
짧게 누르기

**Afterglow**  
(-)를 1초간 누르면  
강도가 1단계로 돌아감

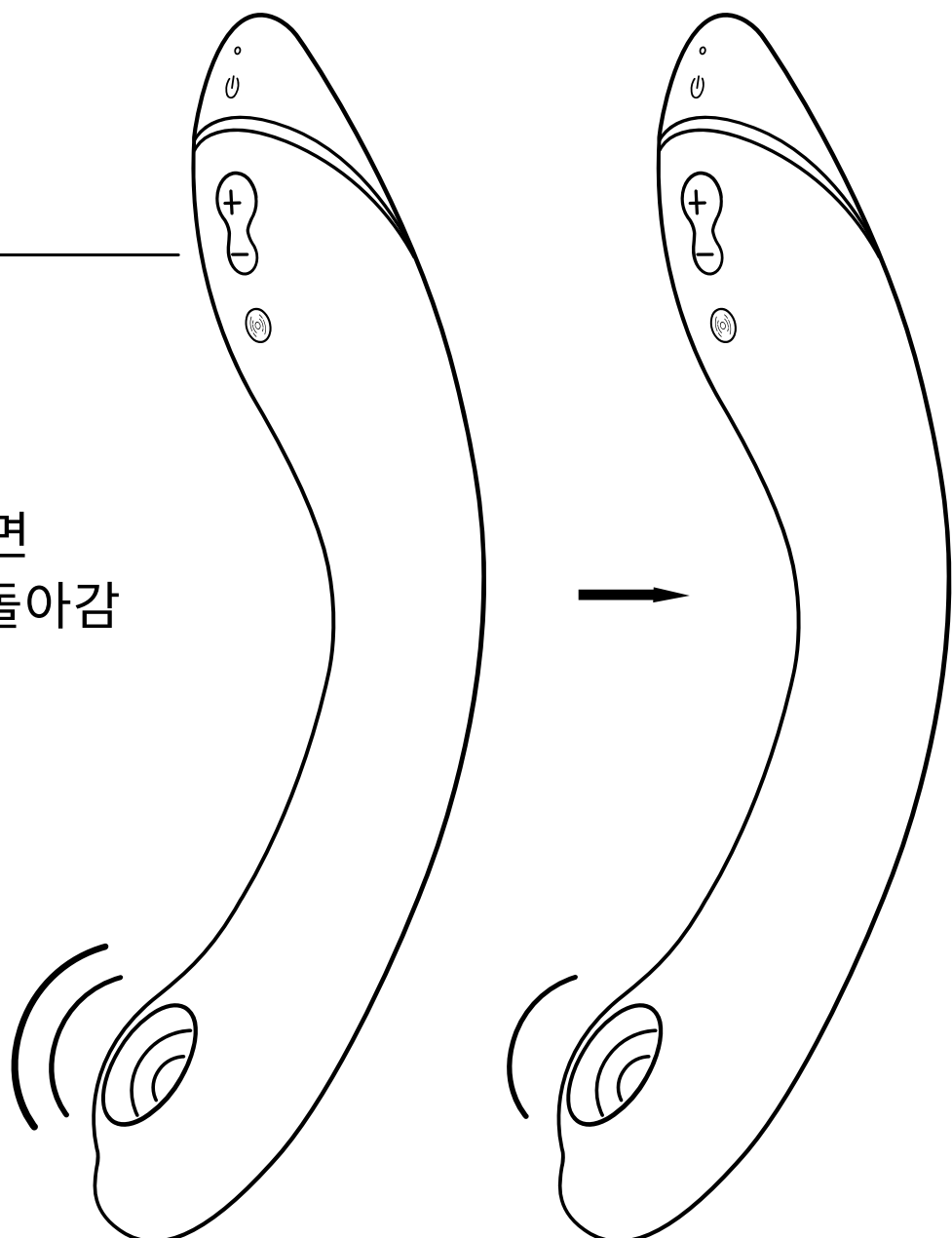

# 사용 방법

4. 전원 끄기  
2초간 누르기

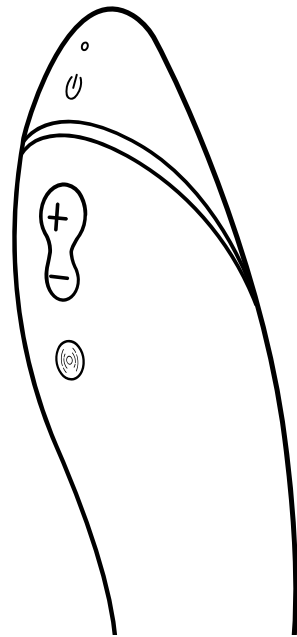

## SMART SILENCE

피부에 거의 접촉했을 때만 **OG**가 켜집니다. Smart Silence는 기본적으로 켜져 있습니다. (+)와 (-) 버튼을 2초간 길게 누르면 Smart Silence를 켜고 끌 수 있습니다.

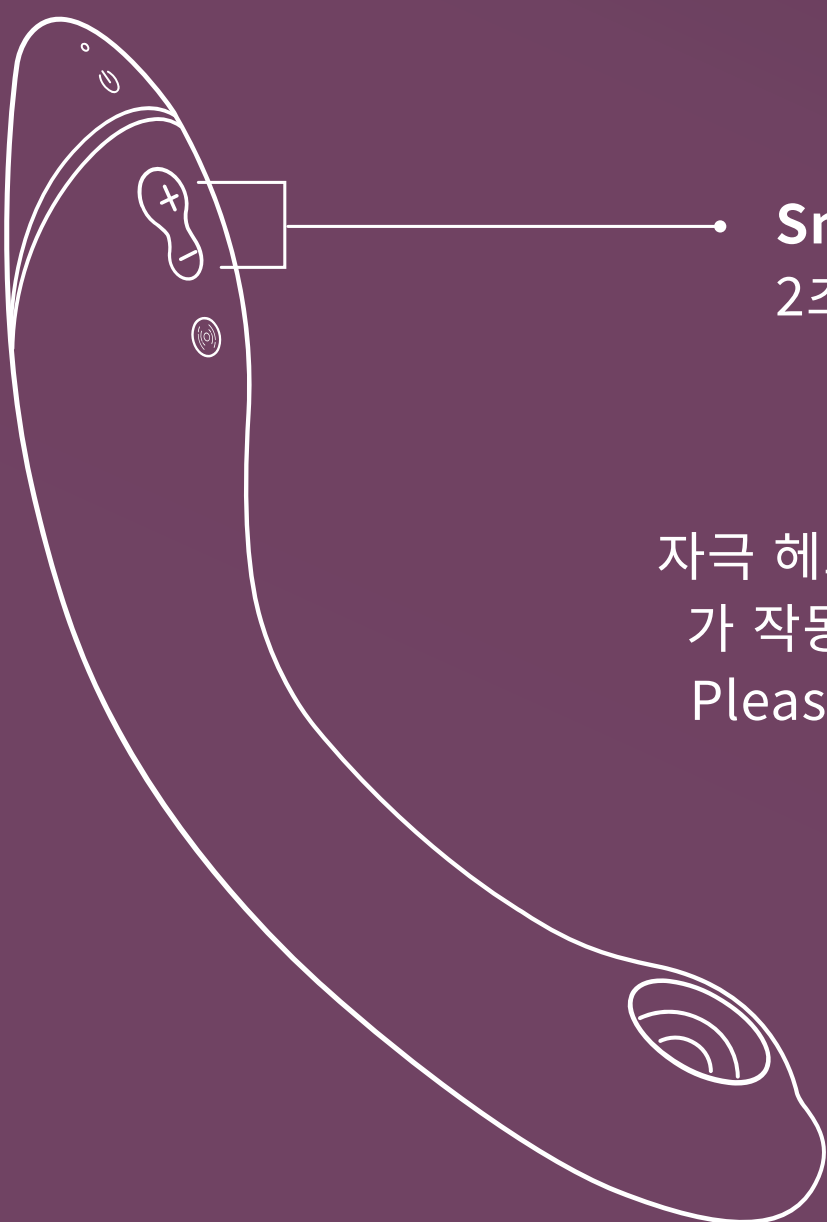

**Smart Silence On/Off**  
2초간 누르기

자극 헤드가 젖었을 때는 Smart Silence가 작동하지 않을 수 있습니다. 따라서, Pleasure Air 헤드 내부에는 윤활제를 바르지 마세요.

# 세척

물에 담가 세척합니다.

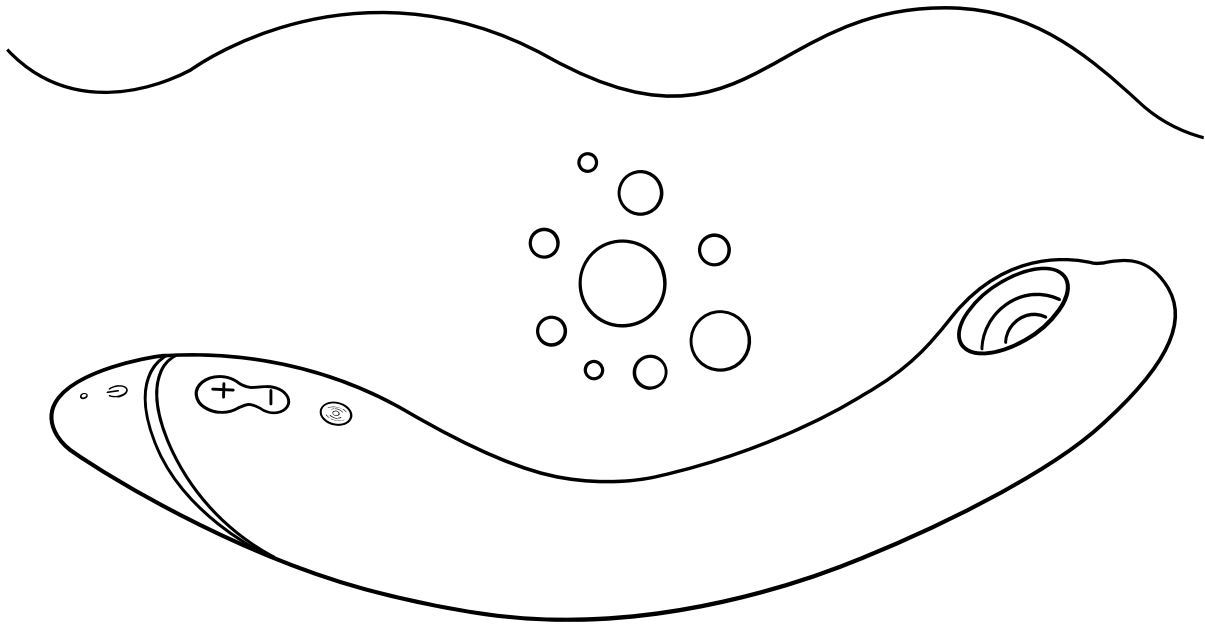

토이 클리너를 사용합니다.

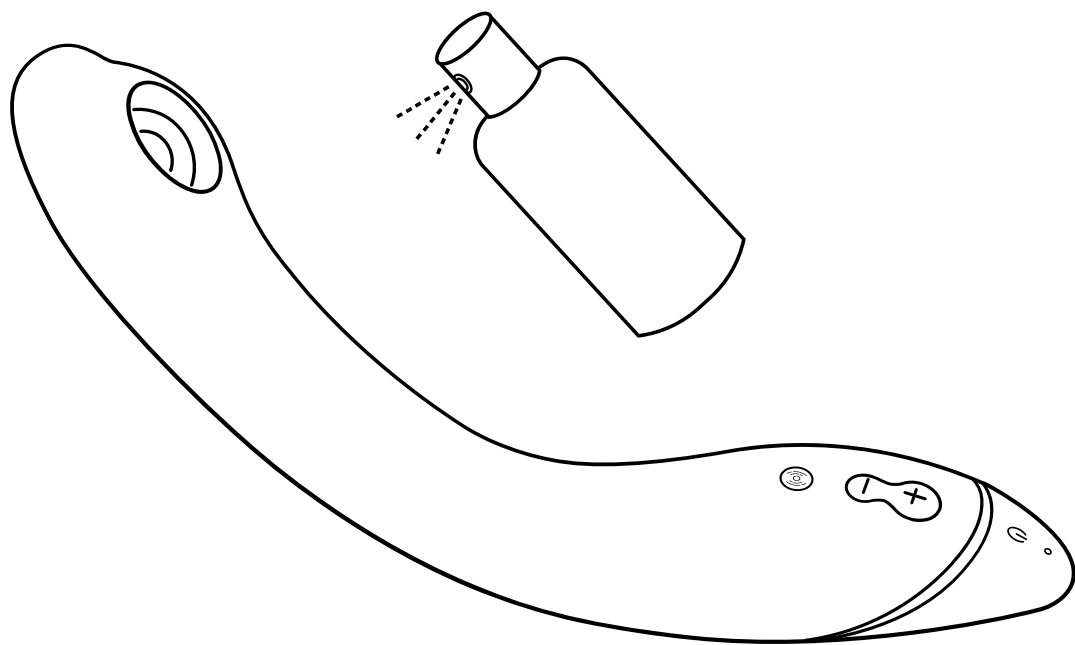

멤브레인을 너무 강하게 누르지 말고  
조심해서 건조합니다.

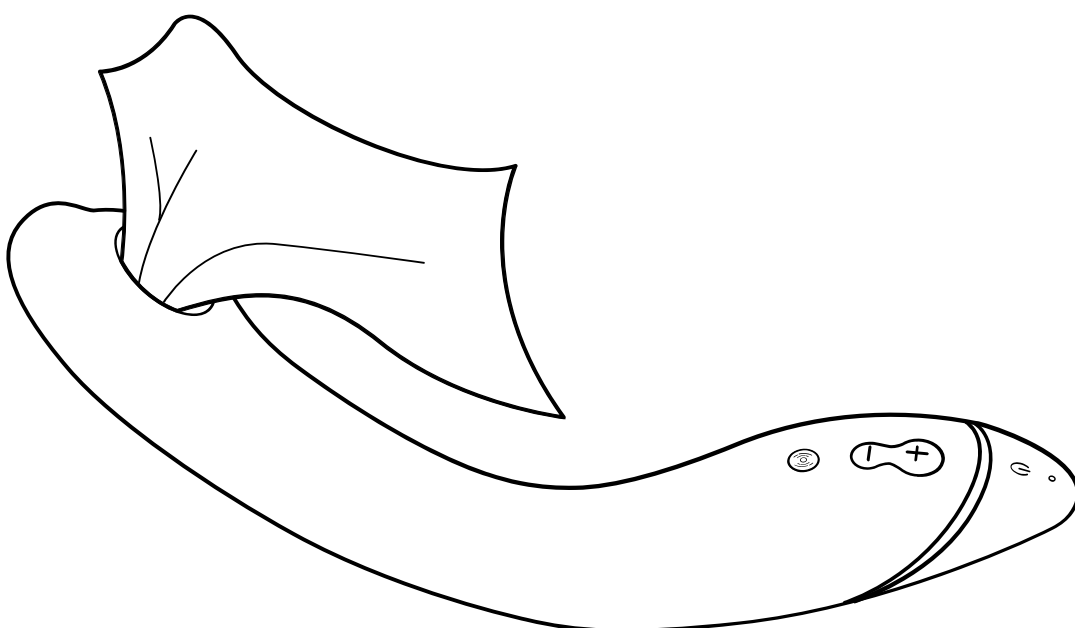

방수(IPX7)

# 충전

**OG**를 처음 사용하기 전에 충전하세요. **OG**를 정기적으로 재충전해야 배터리 수명이 길어집니다.

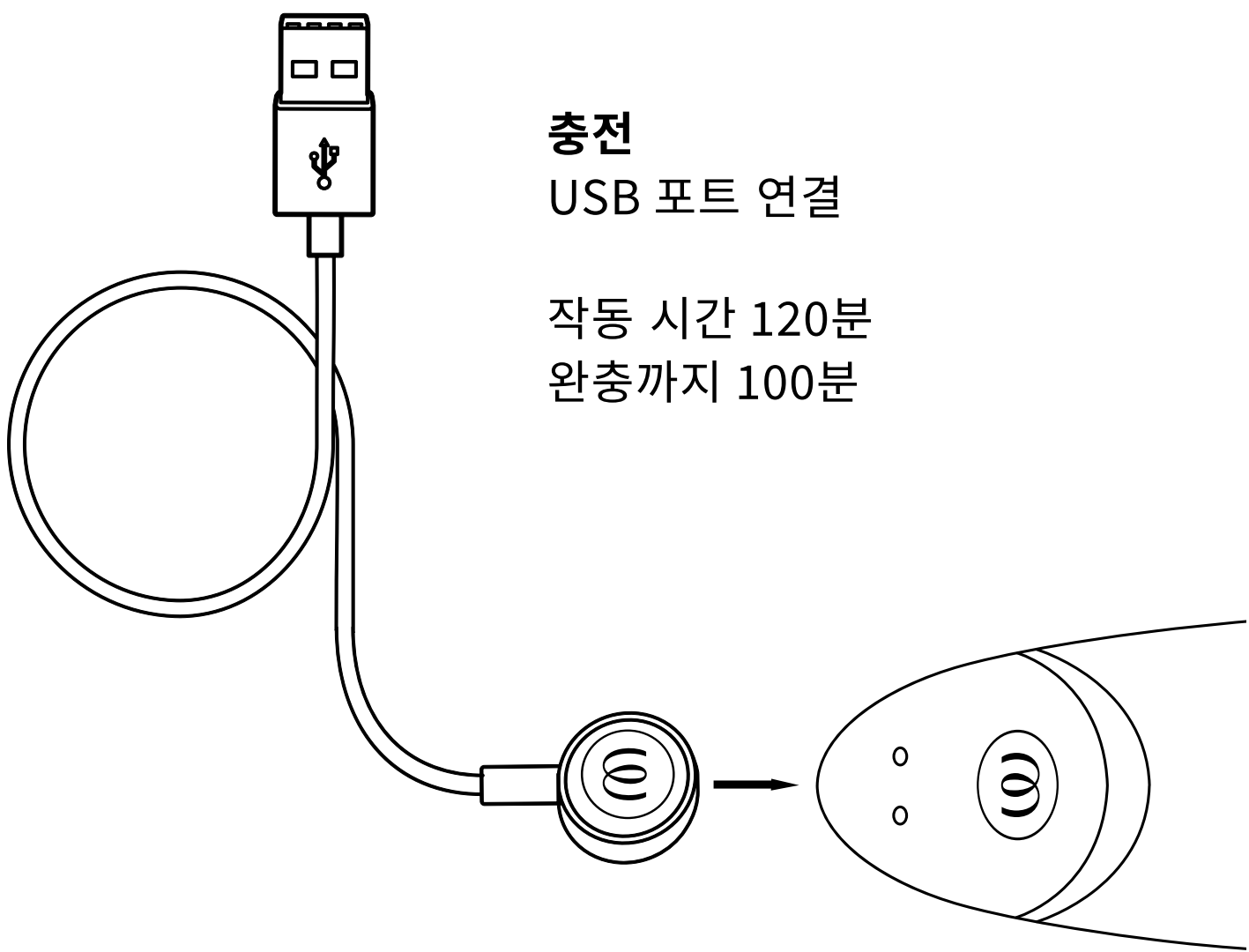

**충전**  
USB 포트 연결

작동 시간 120분  
완충까지 100분

---

**LED**  
On/Off/충전 중

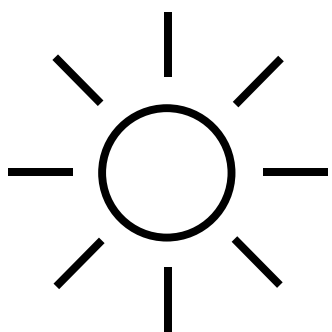

**완충**  
LED 지속 점등

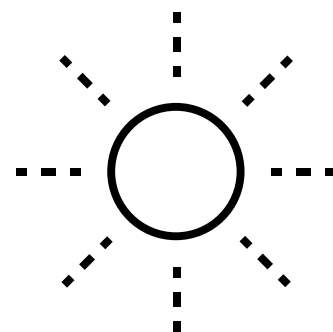

**충전**  
LED 깜박임

# WOMANIZER OG를 최대한 즐길 수 있는 상세한 꿀팁

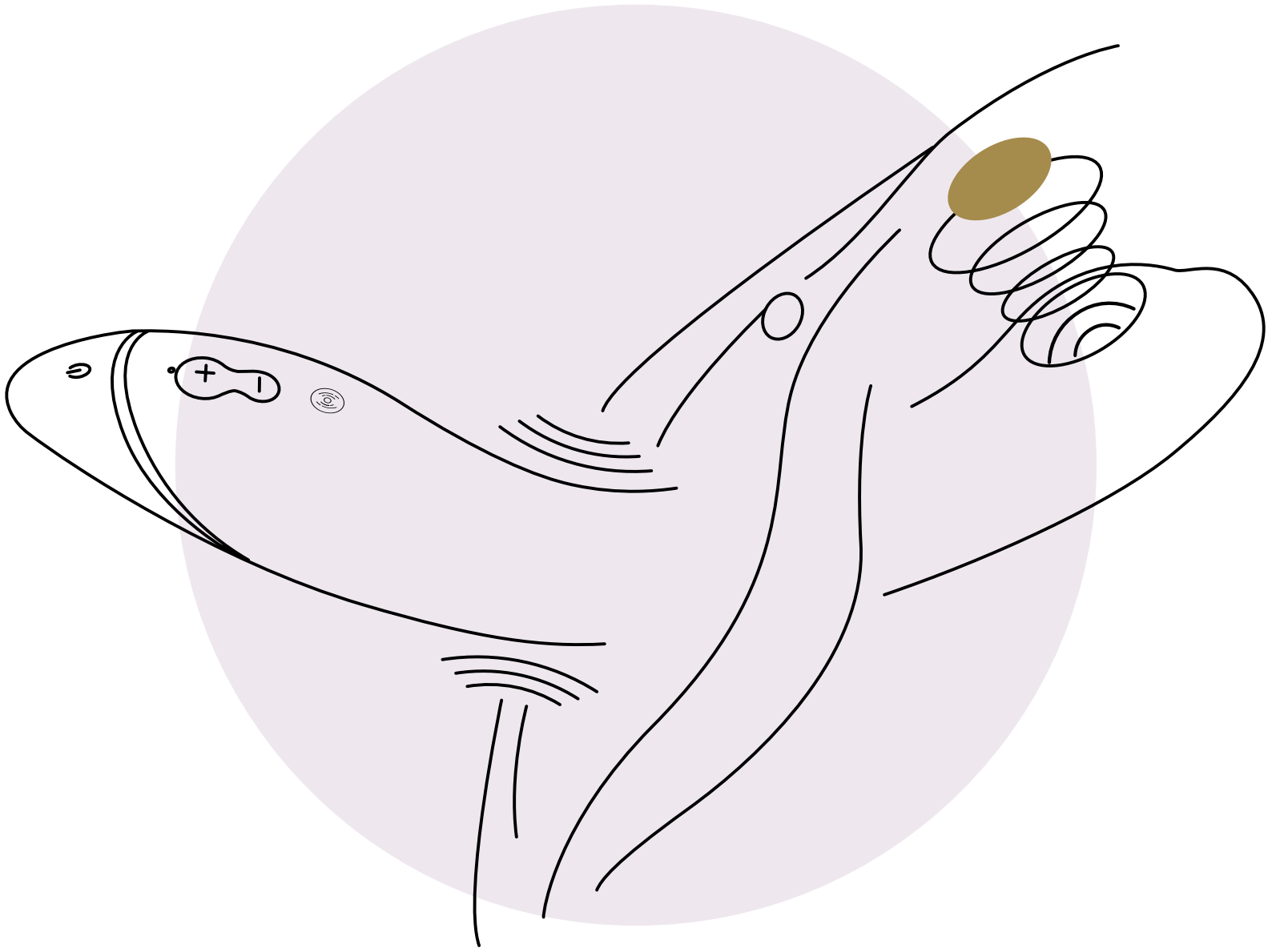

G스팟의 „G“는 산부인과 의사 에른스트 그레펜베르크(Ernst Gräfenberg)의 이니셜을 따라 붙여졌습니다. 스팟이라는 용어가 널리 쓰이기는 하지만, G스팟은 좁은 „스팟“이 아니라, 질 내부에 자극을 수용할 수 있는 내부 클리토리스의 넓은 영역임을 많은 분들이 알고 있습니다.

즉, G스팟은 질벽으로 덮여 있기 때문에 외부에 음핵으로 노출된 클리토리스보다는 덜 민감합니다.

G스팟은 가려져 있기에 느낌을 올리는 데 시간이 더 걸립니다. 자극이 가해지면 커지면서 더 민감해지고 자극을 더 활발하게 수용합니다.

G스팟 오르가즘은 정말 독특한 경험입니다. 이를 느끼기 위해서는 시간이 다소 필요하지만 절정은 무척 강력하고 만족스러우며, 지금까지 느꼈던 즐거움과는 차원이 다른 쾌감을 선사합니다.



# 경험

천천히, 호기심을 갖고 탐구하세요.

**OG** 본체에 수성 윤활제를 바릅니다.



분위기를 잡고 외부 Pleasure Air 자극을 시작합니다.



그런 다음, 내부 Pleasure Air 자극과 진동을 조합하여 즐깁니다.



**OG**는 Pleasure Air 자극과 강력한 진동이 결합된 제품입니다. 다양한 강도와 진동 모드를 시험해보고 나만의 독특한 오르가즘 탐색법을 찾아보세요.

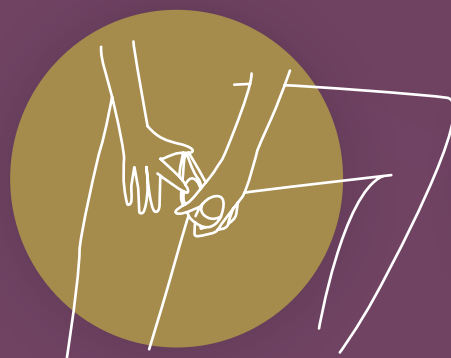
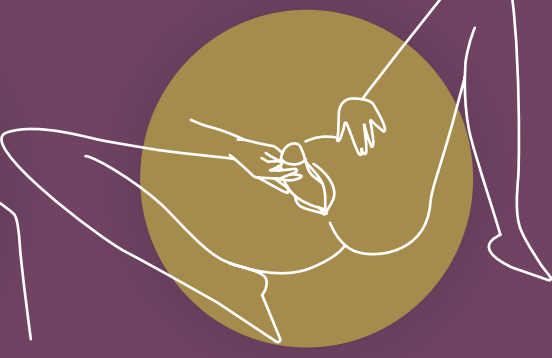
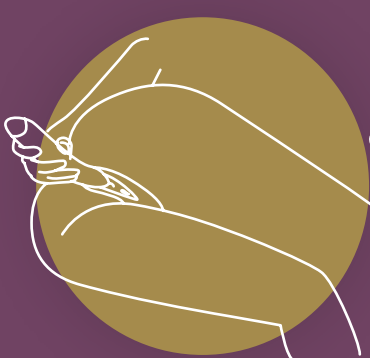

# SAFETY INFORMATION

## 경고

노벨티 제품으로만 판매됨. 제품은 본래의 용도로만 사용하세요. 제품을 어린이의 손이 닿지 않는 곳에 보관하세요. 의료용으로는 부적합. 의사의 관리를 받고 있고/거나 의료 장비 사용이 필요한 증상이 있으면, 본 제품을 사용하기 전에 의사와 상담해 주세요. 피부 자극, 고통 또는 불편감이 있으면 즉시 제품 사용을 중단하고 의사와 상담하세요.

본 기기는 성인만 사용할 수 있고 신체, 감각 또는 정신 능력이 감소되거나 경험과 지식이 부족한 사람도 안전한 기기 사용에 관해 감독이나 지시를 받았고 관련 위험을 이해하고 있는 경우에는 사용할 수 있습니다. 어린이는 기기를 가지고 놀면 안 됩니다. 청소와 사용자 유지 보수는 어린이가 하면 안 됩니다. 붓거나 염증이 있는 피부 부위에는 사용하지 마세요.

- 사용하기 전에 생식기 부위의 피어싱이나 장신구를 제거하세요.
- 항상 매뉴얼의 지침에 따라 사용 후후에 제품을 청소하세요.
- 제품 손상을 피하기 위해, 제품과 제품 배터리는 45°C 넘는 온도에 노출하거나, 분해하거나, 기계적이거나 전 기계적으로 손상을 입히면 안 됩니다.
- 섹스 토이를 함께 쓰면 성병이 옮을 수 있습니다. 섹스 토이는 파트너 외의 다른 사용자와 함께 쓰지 마세요. 필요하면 파트너와 보호 조치를 이용하세요. 커버 재질에 어떤 균열이나 파손 징후가 보이면 토이를 사용하지 마세요.
- 본 제품은 향문용이 아닙니다. 향문에 사용하지 마세요!
- 녹슬지 않도록 흡수면에 제품의 부드러운 쪽을 놓지 마세요.
- 충전 장치와 토이의 손상을 정기적으로 검사하고 부품 손상이 있으면 장치를 사용하지 마세요.
- 자기장은 심박 조율기 같은 기계 및 전자 부품에 영향을 미칠 수 있습니다. 심박 조율기 바로 위에 장치를 사용하지 마세요. 자세한 정보는 의사에게 문의하세요. 마그네틱 스트라이프가 있는 카드(예 : 신용 카드)는 제품의 자석에 손상될 수 있으므로 기기 근처에 가져 가지 마세요.
- 토이가 이상하게 작동하는 것 같이 보이면, 끄고 당사 웹사이트에서 지원 부서와 상담하세요.

## 충전 / 배터리

- 충전 장치를 처음 사용하기 전에는, 현지 전압 레벨을 검사하세요. 현지 전원 전압이 충전 장치 지정 최대 전원 전압을 초과하면 안 됩니다.
- 기기는 기기 표시와 부합하는 안전 저전압 상태로만 공급해야 합니다.
- 배터리가 충전되는 동안 제품을 사용하거나 청소하지 마세요.
- 절대로 물이나 기타 액체에 충전 장치나 케이블을 담그지 마세요.
- 본 기기는 교체 불가 배터리를 장착하고 있습니다.
- 본 제품은 재충전 가능 리튬 이온 배터리를 장착하고 있습니다.
- 각 충전 과정이 끝나면 회로에서 충전 케이블을 분리하세요.

## 제품의 최적 사용을 위한 지침:

- 긴 배터리 수명을 보장하려면, 사용하지 않더라도 장치를 정기적으로 충전하시기 바랍니다.
- 직사 광선에 노출되지 않는 안전하고 건조한 장소에 보관하세요.
- 토이와 함께 물 기반 윤활유를 사용하는 것이 좋습니다. 손상을 피하려면 실리콘 기반이나 알코올 기반의 향기로운 윤활유, 젤 또는 마사지 오일을 사용하지 마세요.

# GENERAL INFORMATION

## ELECTRICAL RATING

**Model:** OG

**Model No.:** TES10A

**Power Input:**

3,7 V=0,62 A: Built-in Li-Polymer rechargeable battery.

5 V=0,5 A: When charged using USB.

Use USB AC adaptor (not included) with power output corresponding to product rating. Use original provided cable only."

## CONTENT OF DELIVERY

Womanizer OG G-Spot vibrator, USB charging cable (AC adapter not included), cotton storage pouch, quick start guide, safety instructions

## ENVIRONMENTAL PROTECTION

As a distributor of electronic devices, we are legally obliged to accept the return of waste electrical and electronic devices free of charge. We expressly state that you as the user are legally obliged to return used batteries.

Never throw away electronic devices or batteries in the household waste. The symbol shown below (crossed-out wheeled bin) is intended to expressly remind you of this.

## MANUFACTURED AND DISTRIBUTED BY

**WOW Tech Europe GmbH**

Hermann-Blankenstein-Strasse 5

10249 Berlin

[www.wowtech.com](http://www.wowtech.com)

WOW Tech Europe GmbH reserves the right to make technical changes and changes to the design that serve to improve the device.

For information regarding patents see [womanizer.com/patents](http://womanizer.com/patents).

## CUSTOMER CARE

[care@womanizer.com](mailto:care@womanizer.com)

[womanizer.com](http://womanizer.com)

Designed in Germany. Made in China.

Date of issue: 10/2022.



아직 더 원하세요?

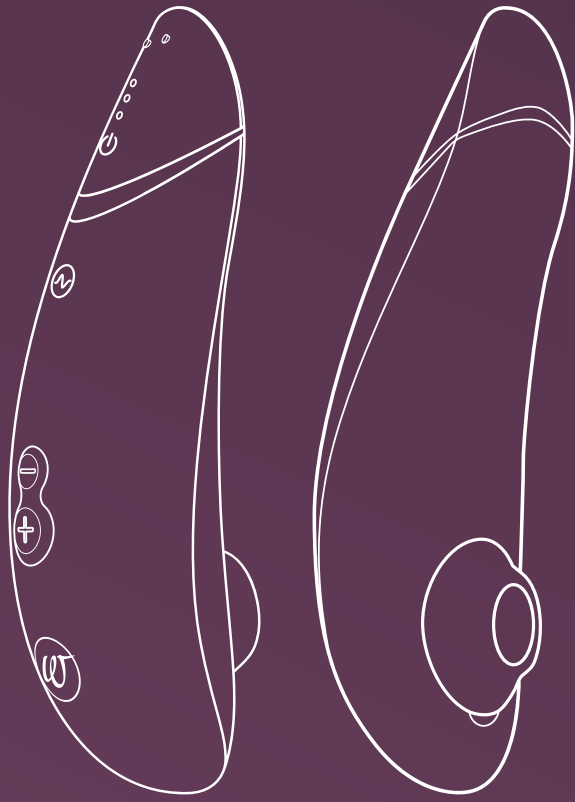

Pleasure Air  
Technology

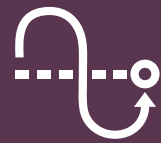

Autopilot



Smart Silence

**Premium 2**  
Define your luxury

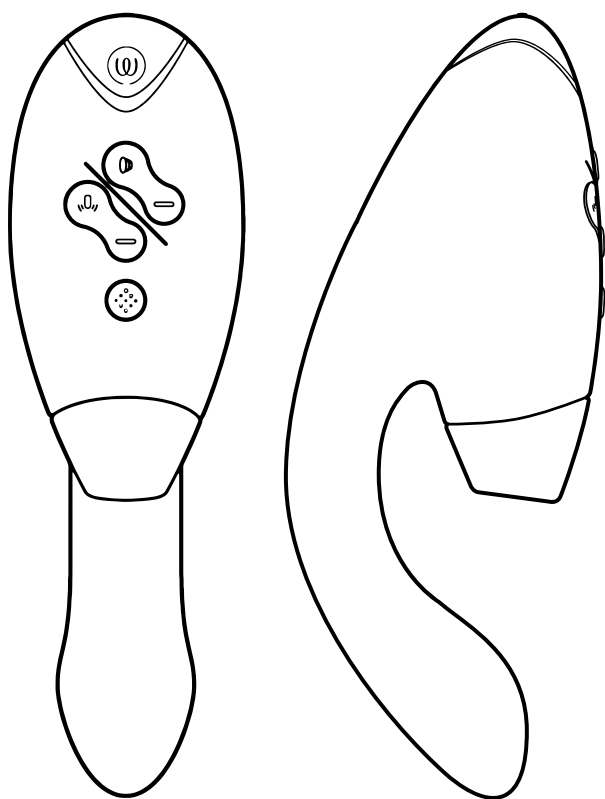

Pleasure Air  
Technology



Double Stimulation

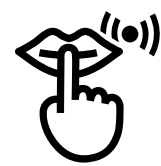

Smart Silence

**DUO 2**  
Indulge in whole-body orgasms



#IMASTURBATE

# Hi!

非常感謝您選擇 **WOMANIZER**

歡迎探索快感迭起的情趣世界，生活从此更加丰富多彩。

歡迎來到充滿感官體驗的世界，讓您的生活豐富多彩。**WOMANIZER** 不但保證讓您享受無與倫比的高潮體驗，更為您創造全新的情慾。

享用您的 **WOMANIZER**——它將帶給您接二連三的高潮。

盡情寵愛自己吧！



描述

使用方法

SMART SILENCE

清潔

充電

如何使用 WOMANIZER OG  
縱享歡愉的一些秘訣

SAFETY INSTRUCTIONS

一般資訊

Please read the safety instructions in the  
Compliance & Safety Information before first use.

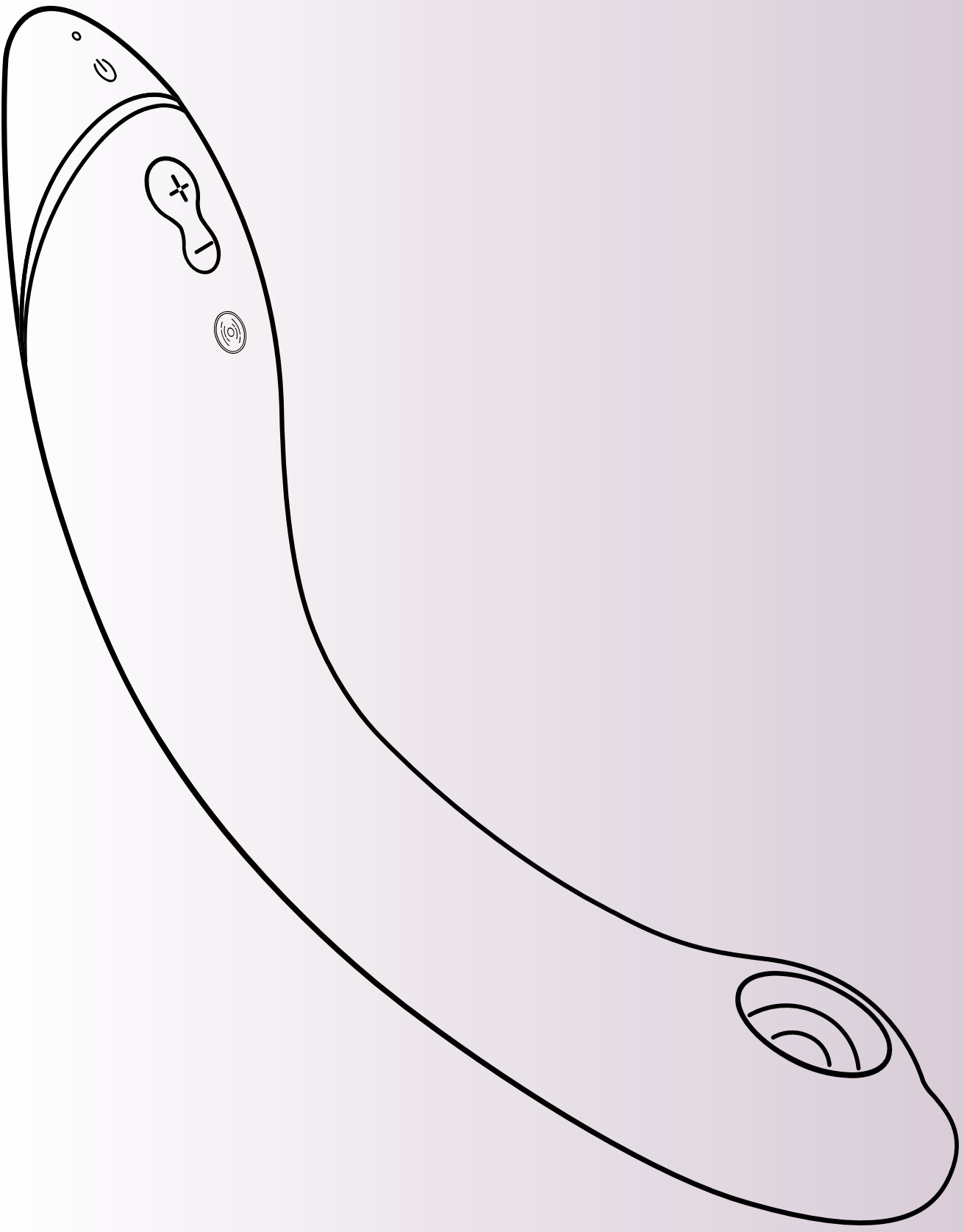



# 說明

**LED 顯示**  
開機/充電

**Smart Silence**  
開/關  
按住 2 秒鐘

**振動**  
短按以啟用和增加強度

**Pleasure Air Technology**  
12 段強度級別

**開/關**  
按住 2 秒

**增加強度**  
短按 (+)

**減小強度**  
短按 (-)

**Afterglow**  
按壓 (-) 1 秒鐘



# 使用方法

## 1. 開機

按住 2 秒鐘

LED 會指示產品已開機。

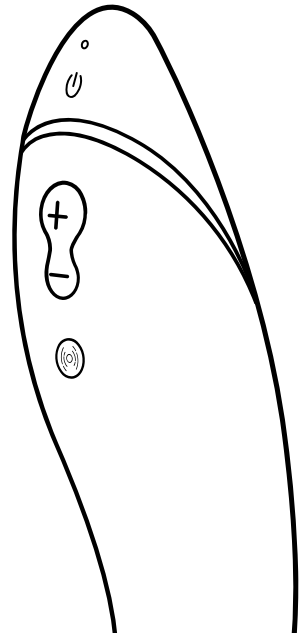

## 2. 用法

為了漸入佳境，  
首先將 **OG** 置於陰蒂上。

將水基潤滑劑塗抹至 **OG** 機身。

適應之後插入 **OG**，  
探索您的 G 點！

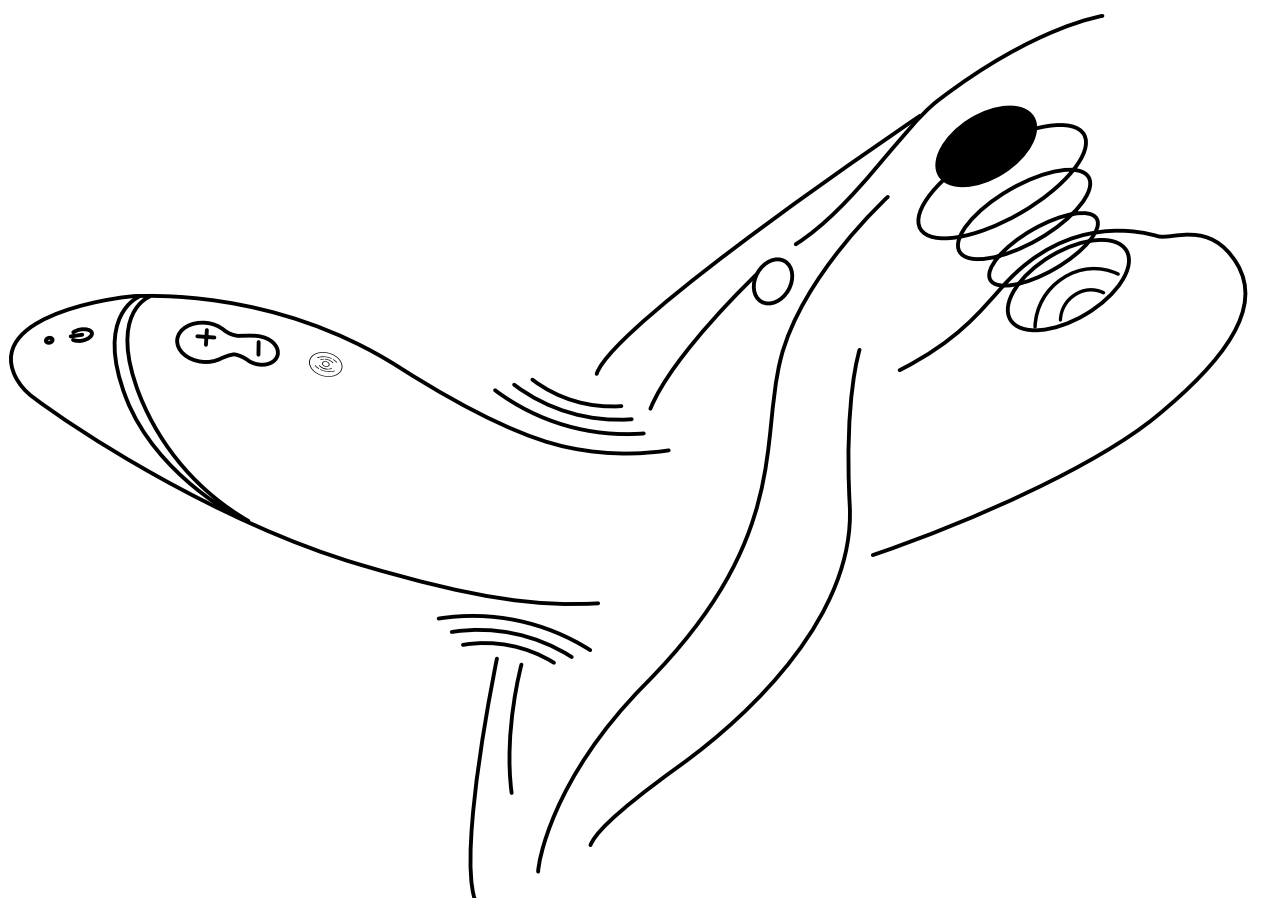
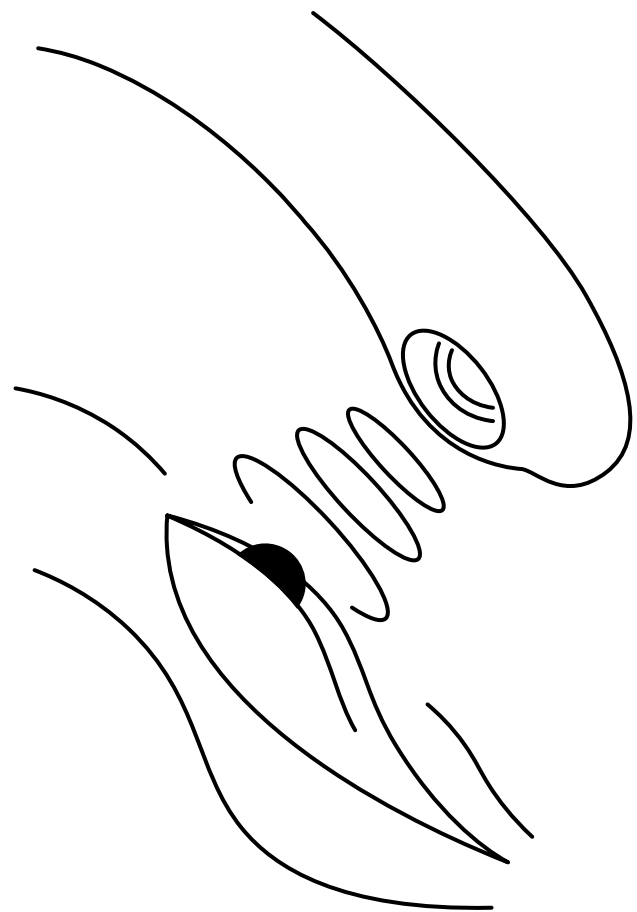

# 使用方法

## 3. 變更強度

增加  
短按  
12 段強度級別

增加  
短按  
3 段振動級別

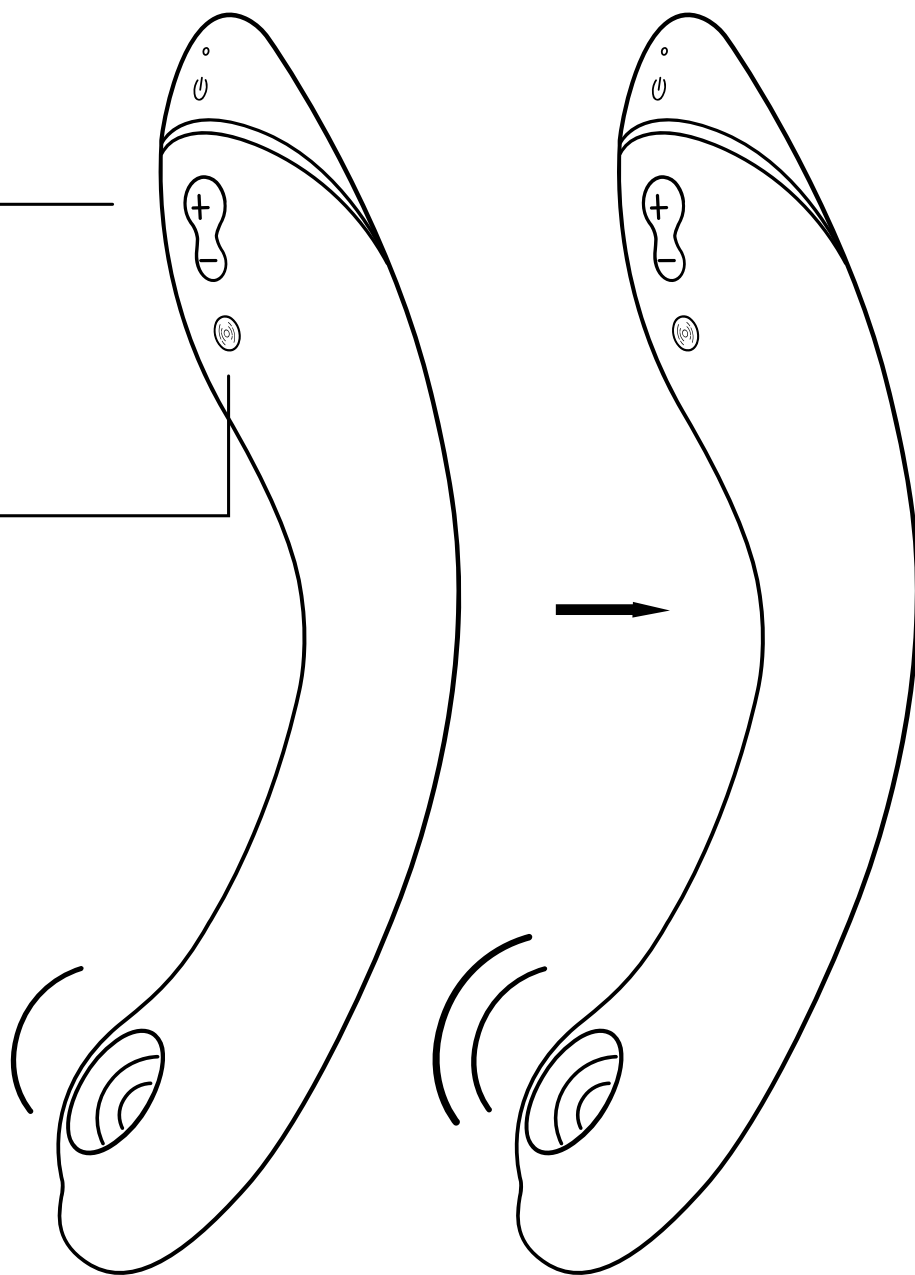

減小  
短按

**Afterglow**  
按壓 (-) 1 秒鐘, 回到強  
度級別 1

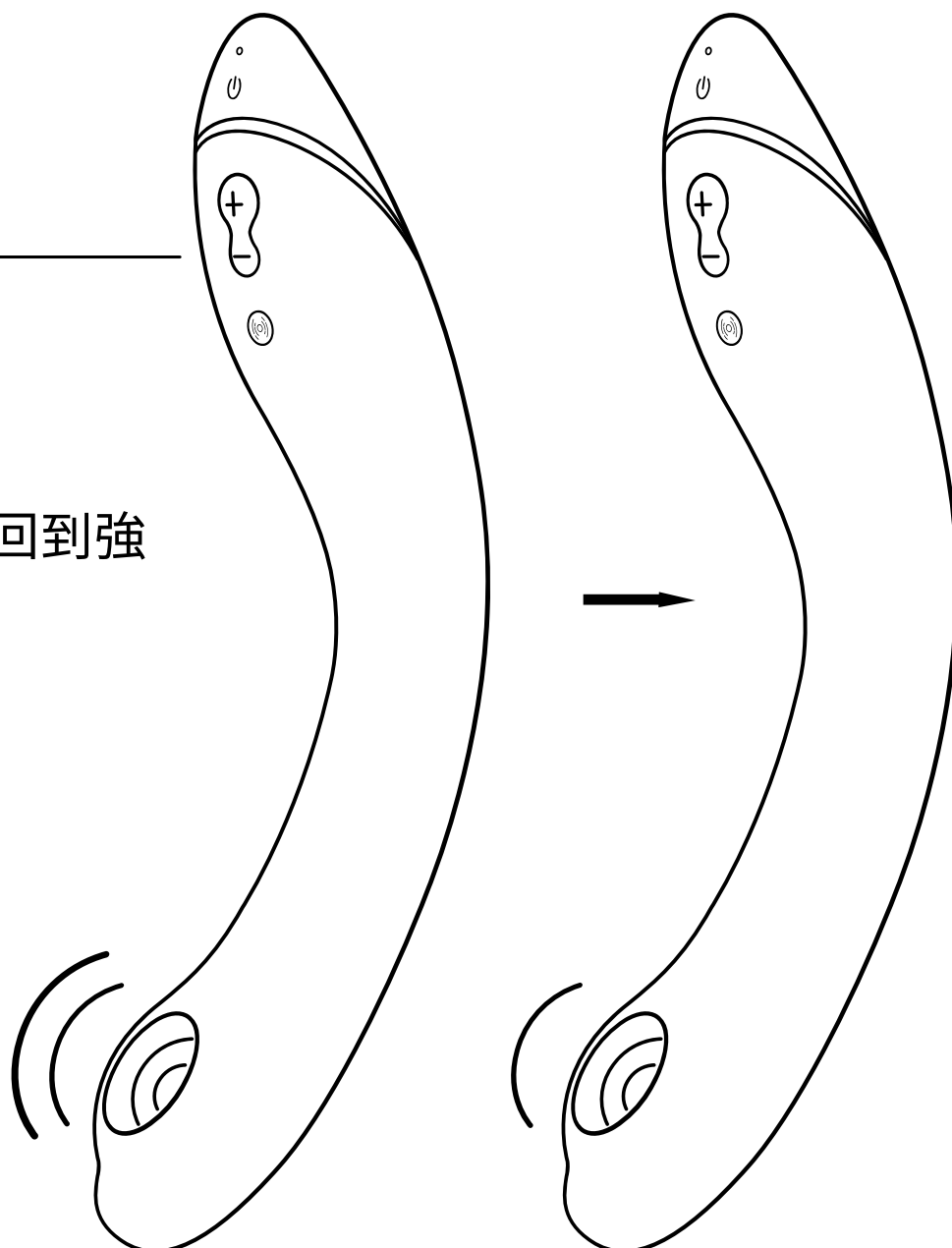

# 如何使用

4. 關機  
按住 2 秒鐘

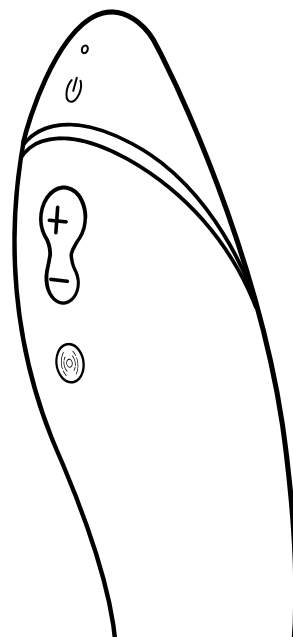

## SMART SILENCE

**OG** 僅在幾乎接觸到您的皮膚時才會開啟。Smart Silence 預設開啟。按住加號和減號按鈕 2 秒鐘即可開啟或關閉 Smart Silence。



**Smart Silence 開/關**  
按住 2 秒鐘

吸吮頭潮濕時，Smart Silence 可能不起作用。因此，請勿在 Pleasure Air 吸吮頭上塗抹潤滑劑。

# 清潔

用水沖洗。

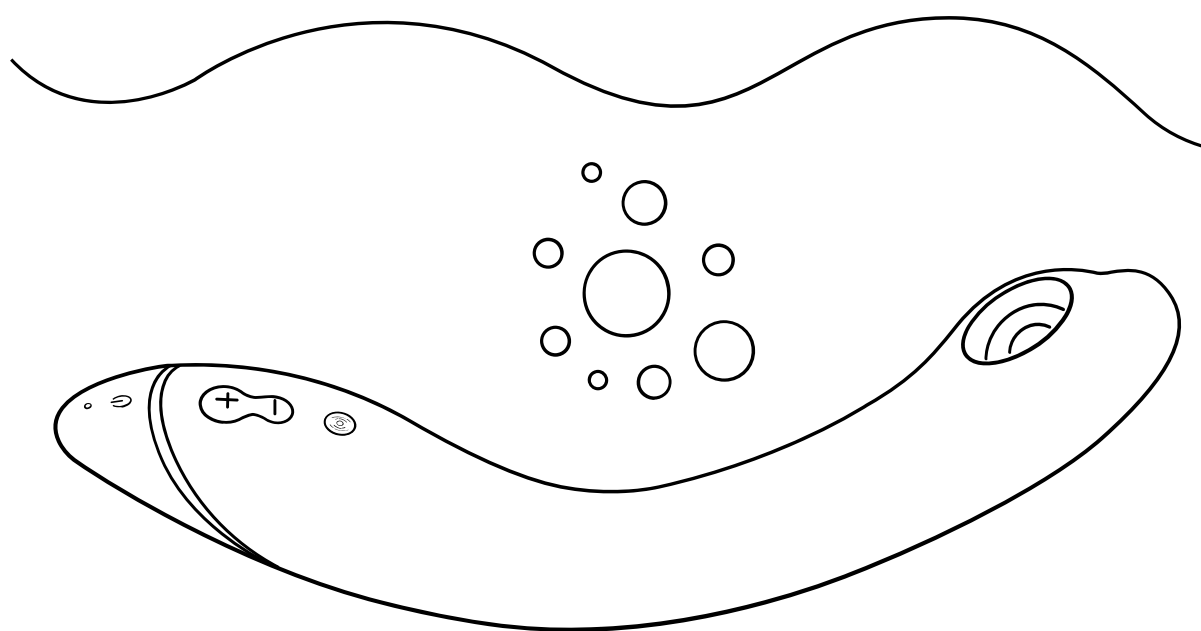

塗抹玩具清潔劑。

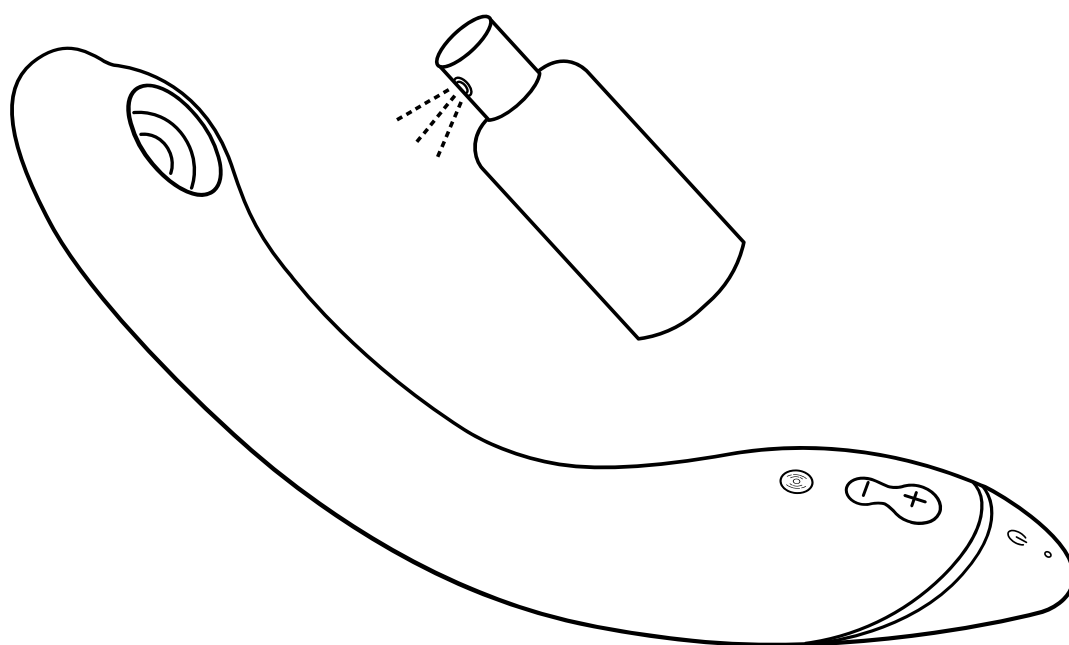

小心弄乾,切勿對薄膜過度施力。

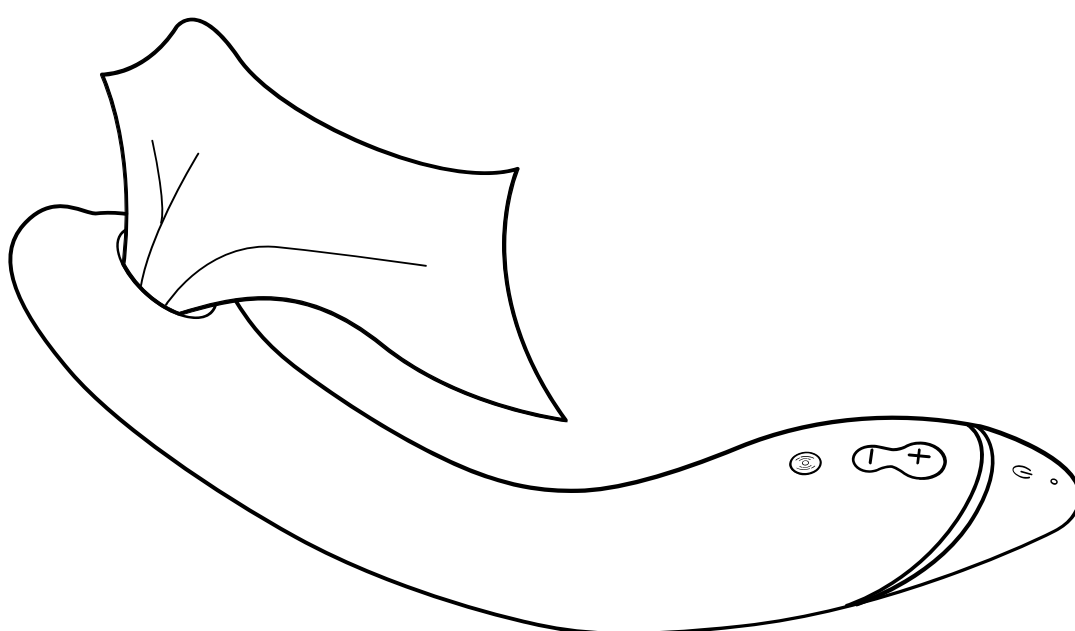

防水 (IPX7)

# 充電

請於初次使用前為 **OG** 充電。同時，請謹記定期為 **OG** 充電，以確保較長的電池壽命。

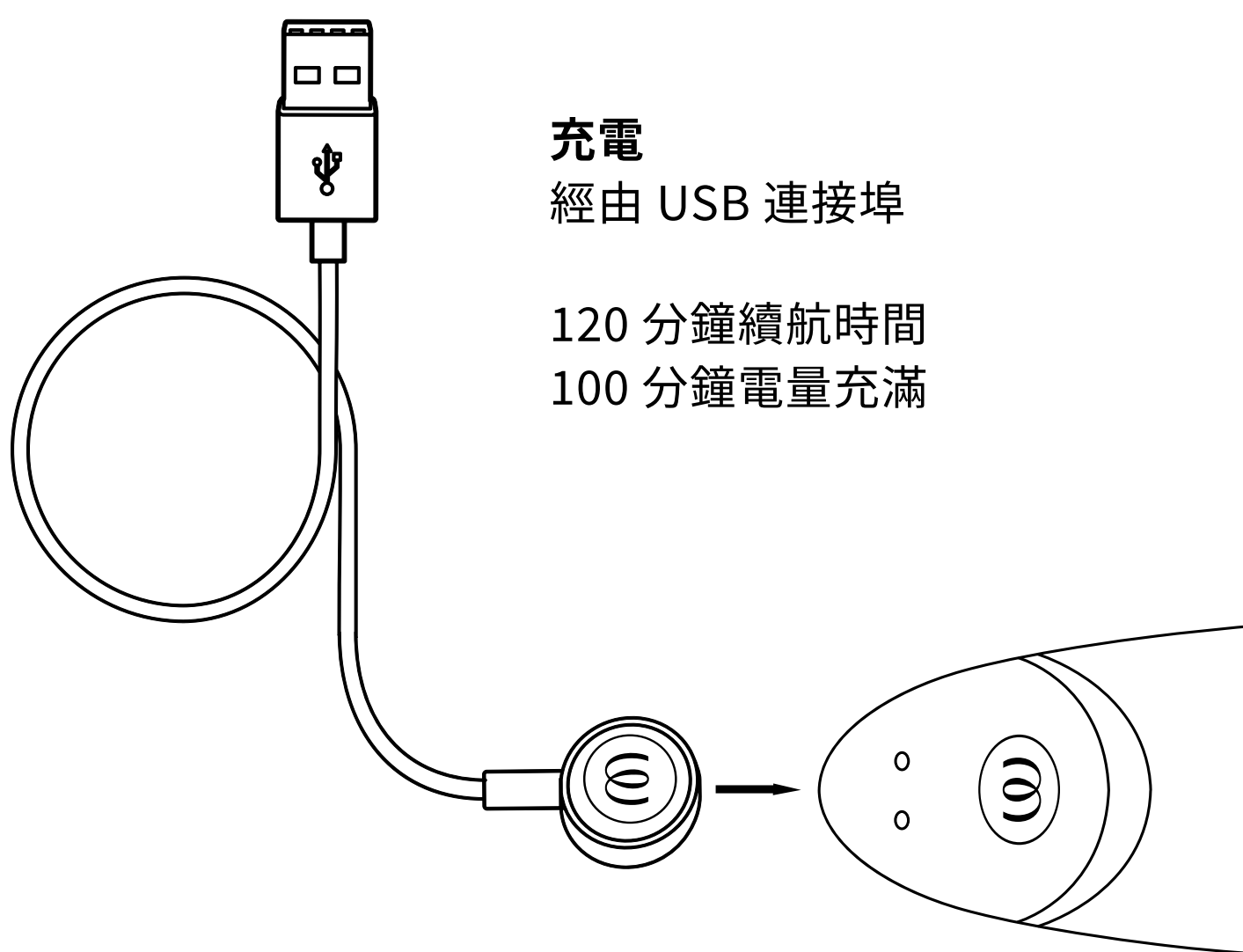

**充電**  
經由 USB 連接埠

120 分鐘續航時間  
100 分鐘電量充滿

---

**LED**  
開/關/充電

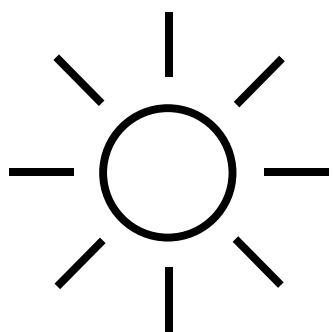

**充電完成**  
LED 會持續亮起

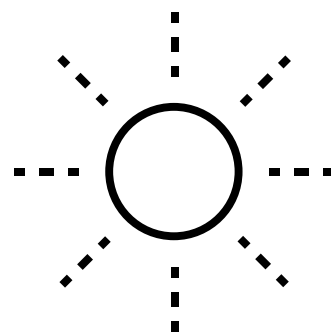

**充電**  
LED 閃爍

# 如何使用 WOMANIZER OG

縱享歡愉的一些秘訣



G 點中的「G」是以醫師 Ernst Gräfenberg 的名字命名的。儘管這一名稱廣為流傳，但據目前所知 G 點並非是一個「點」，而是更大的內陰蒂區域，它可以從陰道內部受到刺激。

這意味著 G 點區被陰道前壁覆蓋，不如暴露的外陰蒂敏感。

由於 G 點被覆蓋，因此需要更多時間才能興奮起來。它會變大，愈發敏感，更容易受到刺激而喚醒性慾。

G 點高潮是一種獨特的體驗。這需要一些時間和耐心，但隨之而來的高潮令人尤為滿足，給予您前所未有的全新感受。

# 經驗

放鬆享受, 勇於探索。

將水基潤滑劑塗抹至 **OG** 機身。



讓自己漸入佳境, 從外部  
Pleasure Air 刺激開始。

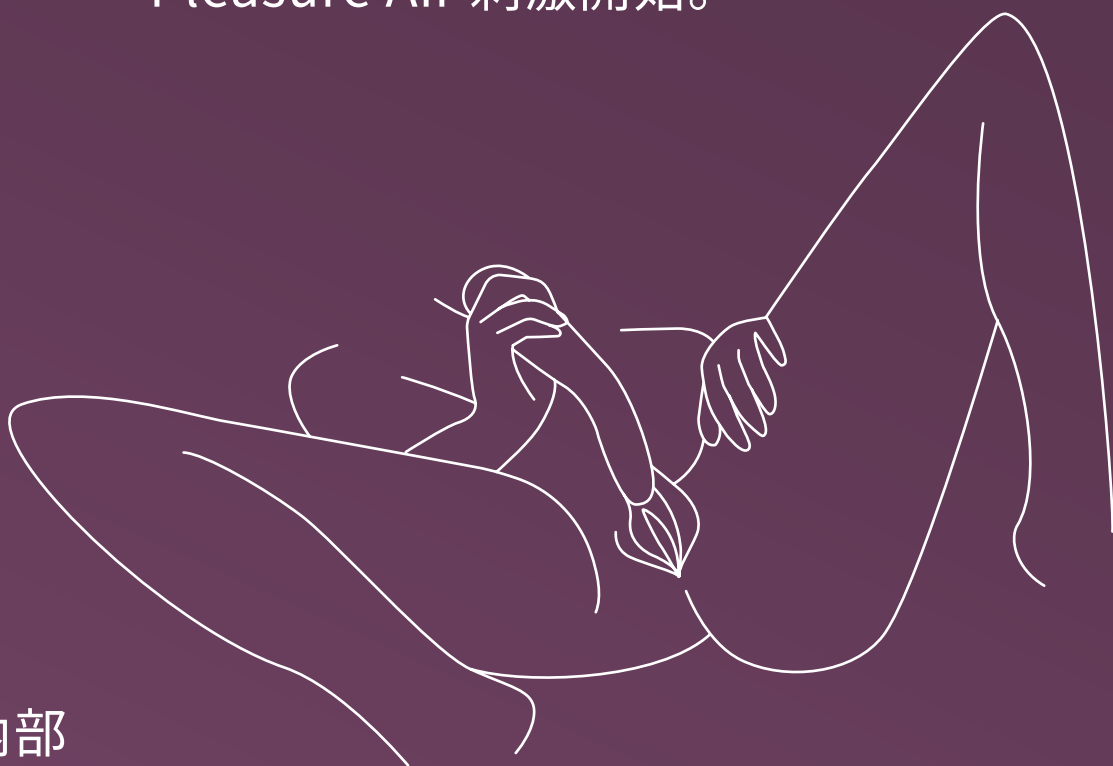
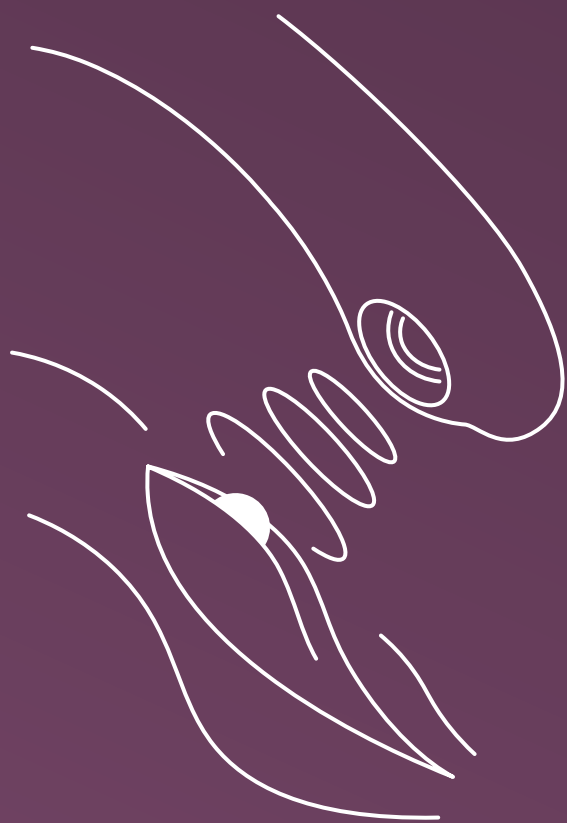

然後再結合振動, 享受內部  
Pleasure Air 刺激。



**OG** 將 Pleasure Air 刺激與強有  
力的振動相結合——嘗試不同的  
強度和振動模式, 為您帶來獨特  
的高潮之旅。

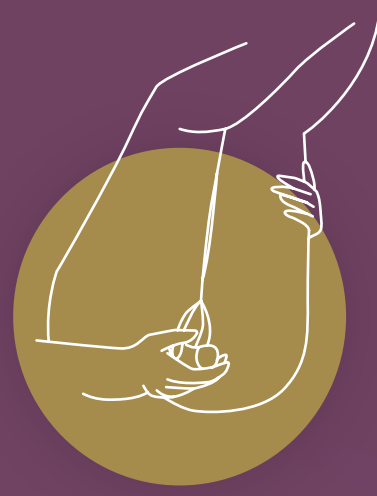
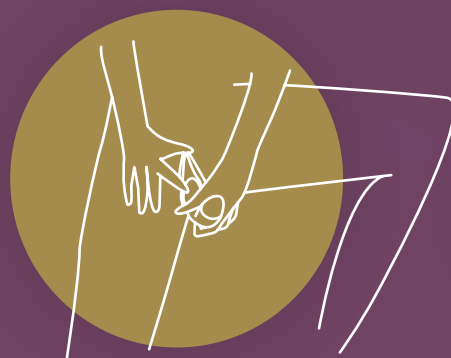
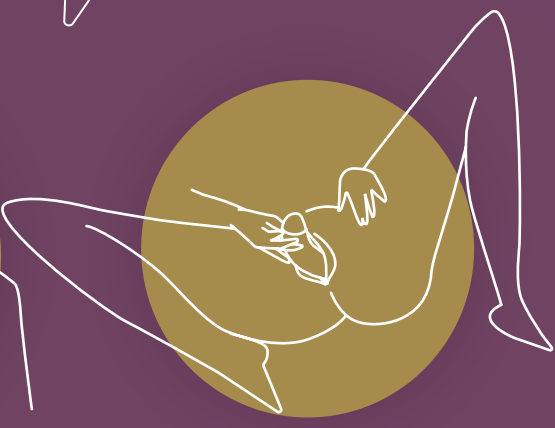
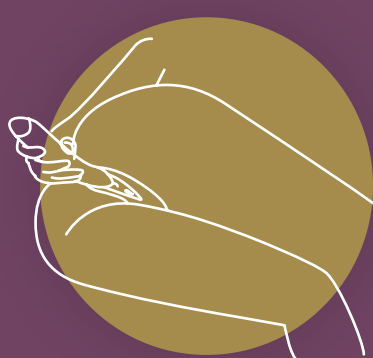



# SAFETY INFORMATION

## 警告

僅以新品出售。僅將本產品用於預定用途。請勿讓兒童接觸產品。不適合用於醫療目的。如果您正接受醫生照護及／或存在需要使用任何醫療裝置的狀況，請在使用本產品之前諮詢您的醫生。如果您感到任何皮膚刺激、疼痛或不適，請立即停止使用本產品，並諮詢醫生。

本裝置僅供成年人使用。生理、感官或心智受限人士，或者經驗及／或知識不足者，在有人監督，或者經過裝置安全使用方法指導並了解相關危險後，亦允許使用。兒童不得玩耍本產品。清潔和用戶維護不應由兒童進行。請勿用於皮膚腫脹或發炎區域。

- 使用前，請去除生殖器部位的珠寶穿孔。
- 在使用前後，請務必按照手冊中的說明清潔產品。
- 為避免產品損壞，請勿將產品及其電池暴露在溫度高於45°C的環境、對其進行拆卸，或使其受到機械或電氣損壞。
- 共享性愛玩具可能會傳染性疾病。除伴侶之外，請勿與其他用戶分享您的性愛玩具。與您的伴侶共用時，如有需要，請使用防護措施。如果發現包覆材料有裂紋或剝落跡象，請勿使用玩具。”
- 本產品不適用於肛門內。請勿插入肛門！
- 請勿將產品柔軟的一邊置於吸水表面之上，以避免造成污漬。
- 定期檢查充電裝置和產品是否損壞，如果任何零件出現損壞，請勿使用裝置。
- 磁場會影響機械和電子零件，例如心律調節器。請勿在心律調節器上方直接使用本產品。如需更多資訊，請與您的醫生聯絡。請勿將帶有磁條的卡（例如信用卡）放在產品附近，因為產品上的磁鐵可能會損壞這些卡片。
- 如果您懷疑玩具出現功能異常，請關閉電源並諮詢我們網站上的技術支援。

## 電池

- 第一次使用充電裝置之前，請檢查當地電壓，因為當地電源電壓不得超過本充電裝置規定的最大電源電壓。
- 本產品只能以產品上標記使用的安全特低電壓供電。
- 電池充電時請勿使用或清潔產品。
- 切勿將充電裝置或充電線浸入水或其他液體中，或用水或其他液體沖洗。
- 本裝置隨附不可更換電池。
- 本產品附一個可充電的鋰離子電池。
- 每次充電後，請切斷充電線與電路的連接。

## 為確保最佳使用產品，請遵循以下準則：

- 為延長電池壽命，即使不使用裝置，也請定期為裝置充電。
- 存放在安全、乾燥的地點，避免陽光直射。
- 我們建議您在使用玩具時搭配水性潤滑劑。請勿使用含香精、矽性或含酒精的潤滑油、凝膠或按摩精油，以免造成損壞。

# GENERAL INFORMATION

## ELECTRICAL RATING

**Model:** OG

**Model No.:** TES10A

**Power Input:**

3,7 V=0,62 A: Built-in Li-Polymer rechargeable battery.

5 V=0,5 A: When charged using USB.

Use USB AC adaptor (not included) with power output corresponding to product rating. Use original provided cable only."

## CONTENT OF DELIVERY

Womanizer OG G-Spot vibrator, USB charging cable (AC adapter not included), cotton storage pouch, quick start guide, safety instructions

## ENVIRONMENTAL PROTECTION

As a distributor of electronic devices, we are legally obliged to accept the return of waste electrical and electronic devices free of charge. We expressly state that you as the user are legally obliged to return used batteries.

Never throw away electronic devices or batteries in the household waste. The symbol shown below (crossed-out wheeled bin) is intended to expressly remind you of this.

## MANUFACTURED AND DISTRIBUTED BY

**WOW Tech Europe GmbH**

Hermann-Blankenstein-Strasse 5

10249 Berlin

[www.wowtech.com](http://www.wowtech.com)

WOW Tech Europe GmbH reserves the right to make technical changes and changes to the design that serve to improve the device.

For information regarding patents see [womanizer.com/patents](http://womanizer.com/patents).

## CUSTOMER CARE

[care@womanizer.com](mailto:care@womanizer.com)

[womanizer.com](http://womanizer.com)

Designed in Germany. Made in China.

Date of issue: 10/2022.



還想要更多？

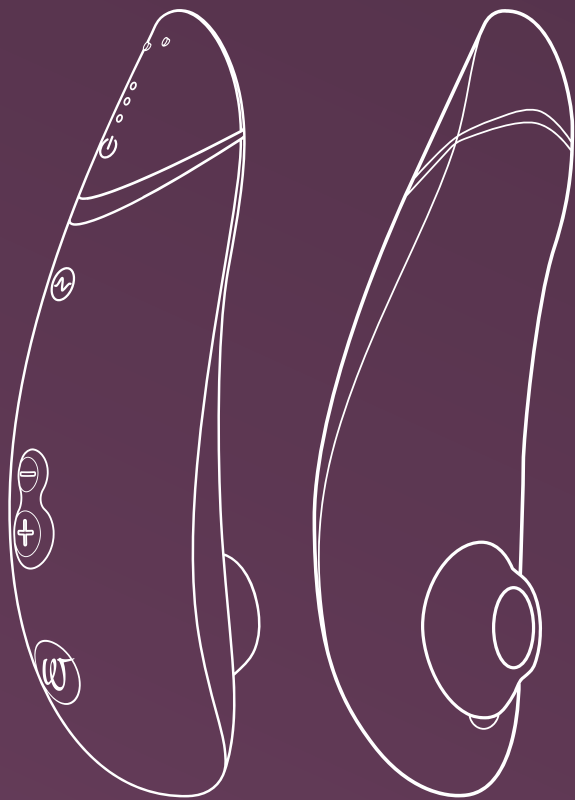

Pleasure Air  
Technology

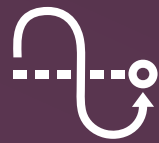

Autopilot



Smart Silence

**Premium 2**  
Define your luxury

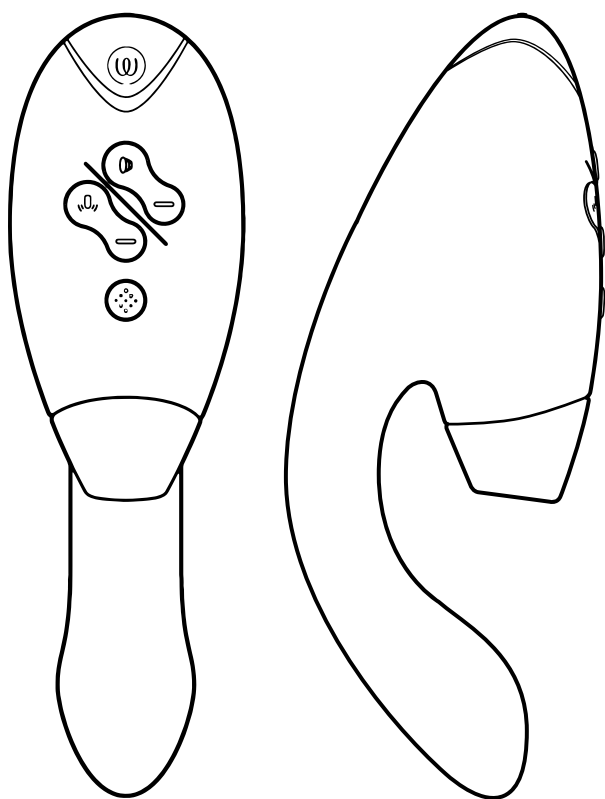

Pleasure Air  
Technology



Double Stimulation



Smart Silence

**DUO 2**  
Indulge in whole-body orgasms



#IMASTURBATE

# Hi!

**WOMANIZER**をお選びいただき、ありがとうございます。

あなたの人生を豊かにする官能的な体験に満ちた世界へようこそ。**WOMANIZER**は比類のないオーガズムだけでなく、まったく新しい快感をお届けします。

次々にオーガズムが訪れる**WOMANIZER**をお楽しみください。

耽美な世界へ!



説明

使用方法

SMART SILENCE

お手入れ

充電

WOMANIZER OGで快楽を心ゆく  
までお楽しみいただくためのヒント

SAFETY INSTRUCTIONS

一般情報

Please read the safety instructions in the  
Compliance & Safety Information before first use.

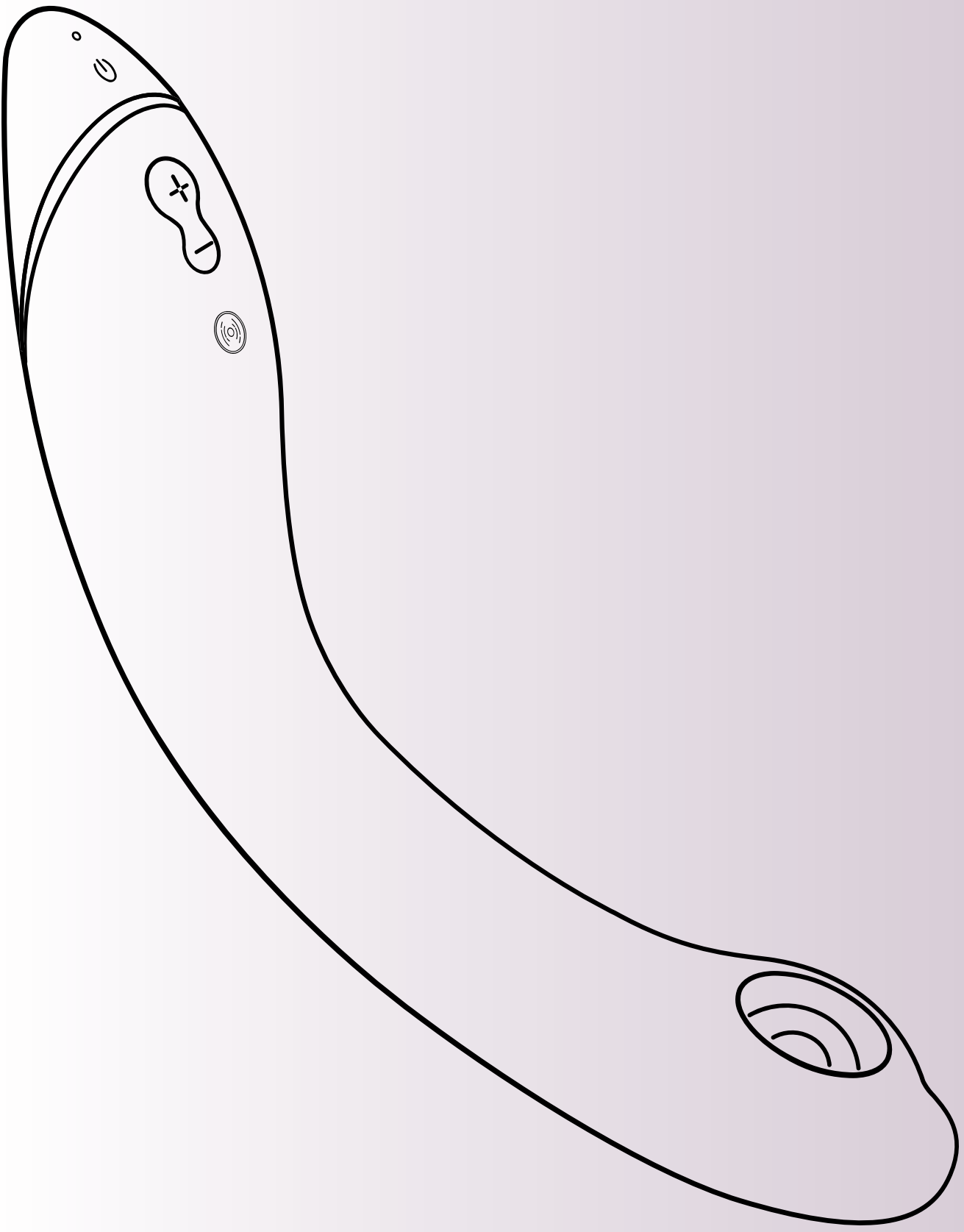

# 説明

**LED表示**  
オン/充電中

**Smart Silence**  
オン/オフ  
2秒押します

**バイブレーション**  
短押しすると、強度を  
作動・上げることができます

**Pleasure Air Technology**  
12段階の強度レベル

**オン/オフ**  
2秒間押します。

**強度を上げる**  
(+)を短押しします

**強度を落とす**  
(-)を短押しします

**余韻**  
(-)を1秒押します





# 使用方法

## 1. 使用方法

2秒押します

LEDは、製品の電源が入っていることを示します。

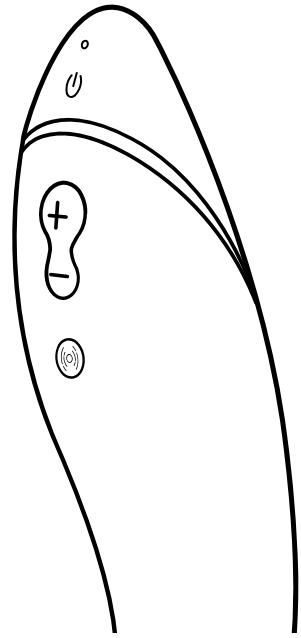

## 2. 使用方法

ムードを盛り上げるために、まずクリトリスに**OG**を使用します。

**OG**の本体に水性潤滑ジェルを塗ります。

感覚が高まった後に、**OG**を挿入してGスポットを探してみましょう！

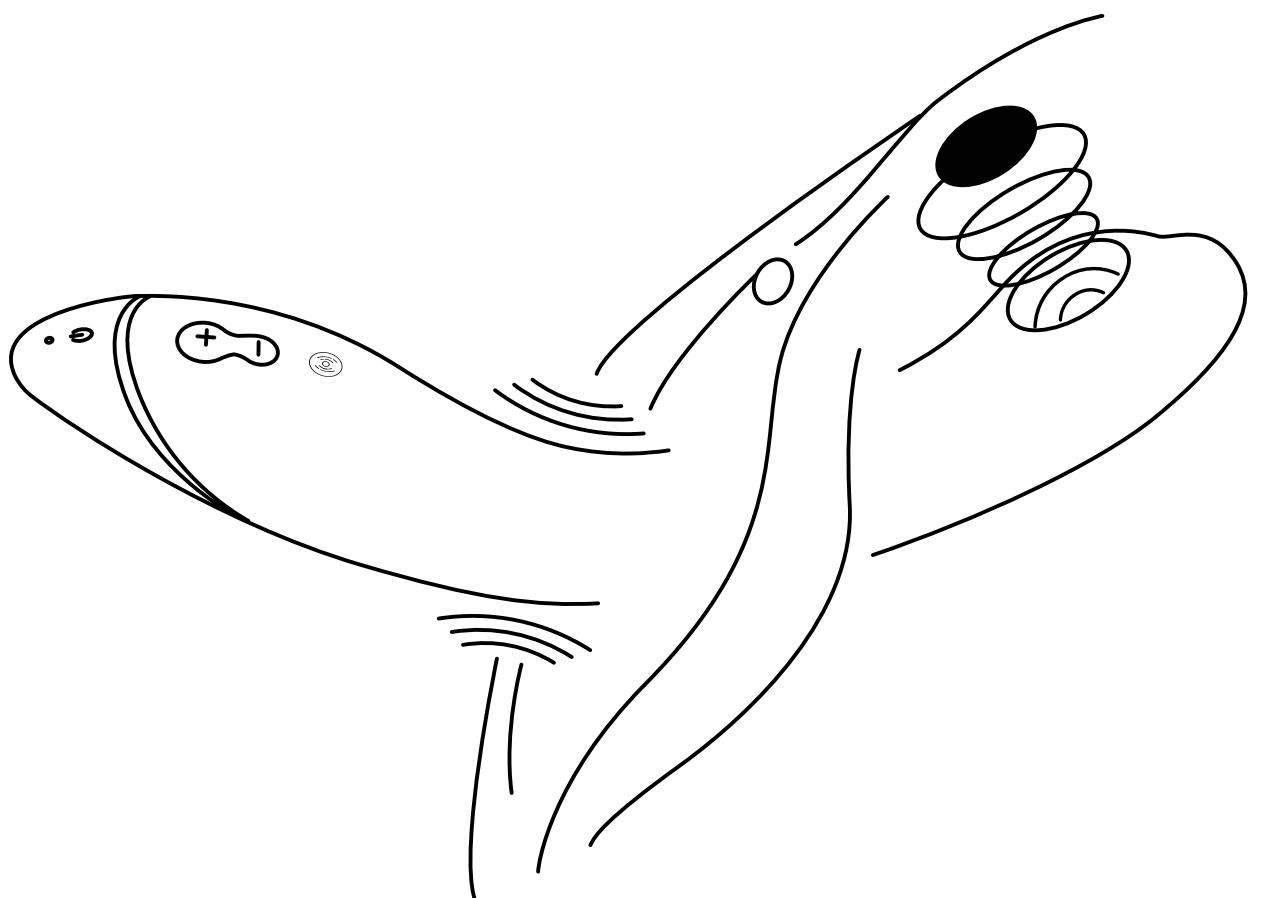
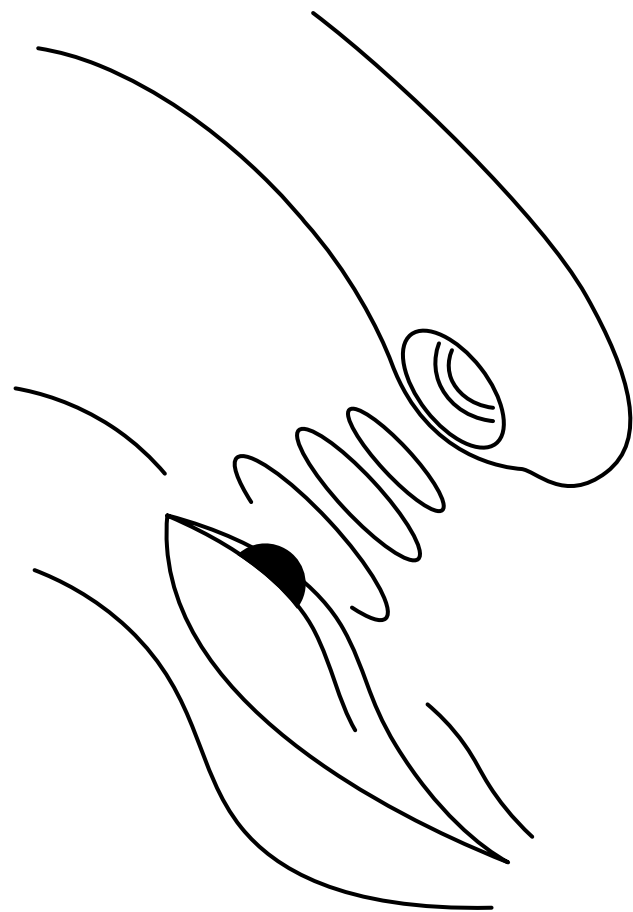

# 使用方法

## 3. 強度の変更

増加 ●  
短押しします  
12段階の強度レベル

増加 ●  
短押しします  
3段階の振動レベル

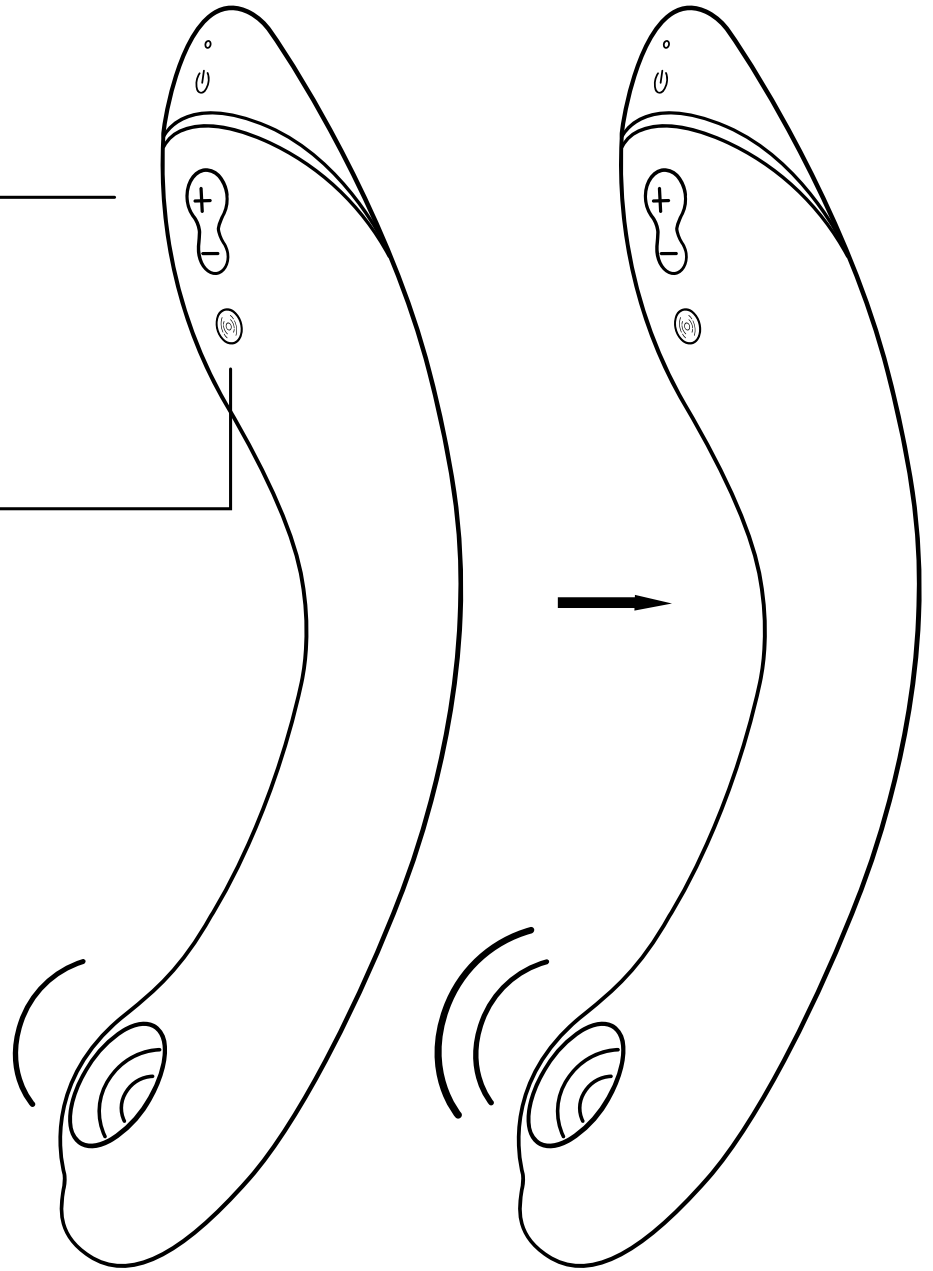

減少 ●  
短押しします

余韻  
「-(マイナス)」を1秒間  
押すと強度レベル1に戻  
ります

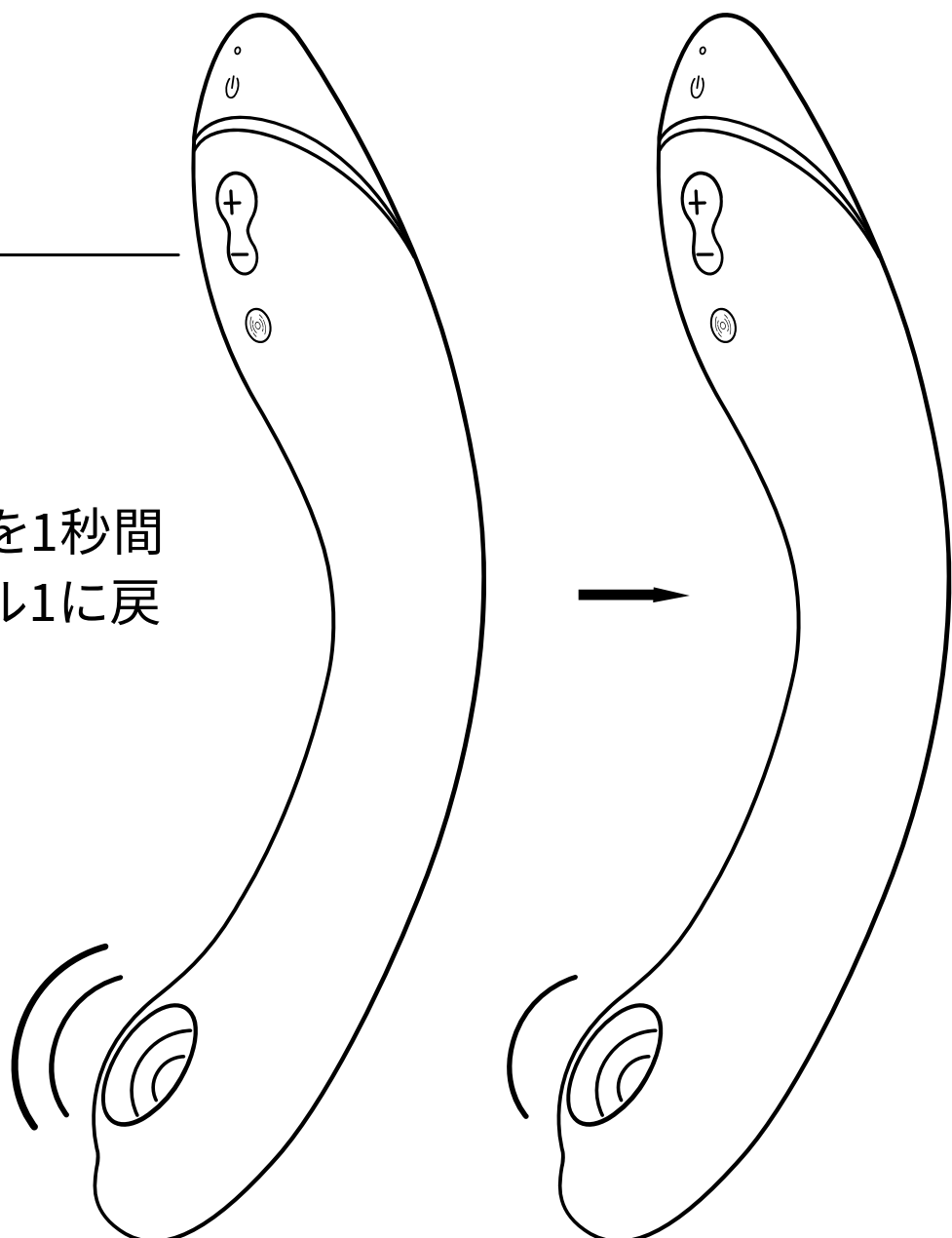

# 使用方法

4. **電源を切る** 2秒押しします

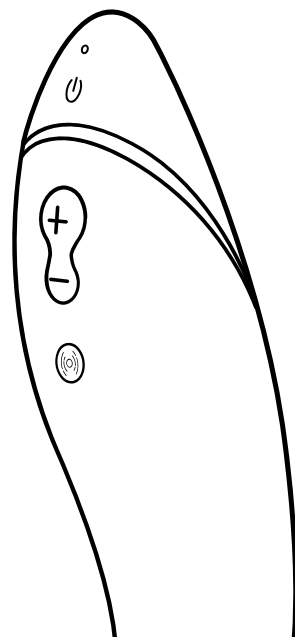

## SMART SILENCE

0が肌に触れそうになったときにのみ電源が入ります。Smart Silenceはデフォルトでは電源が入りません。Smart Silenceの電源を入れる/切るには、プラスとマイナスのボタンを2秒長押しします。



**Smart Silence オン/オフ**  
2秒押しします

スティミュレーションヘッドが濡れていると、Smart Silenceが機能しない場合があります。そのため、Pleasure Airに潤滑ジェルを塗らないでください。

# お手入れ

水洗いします。

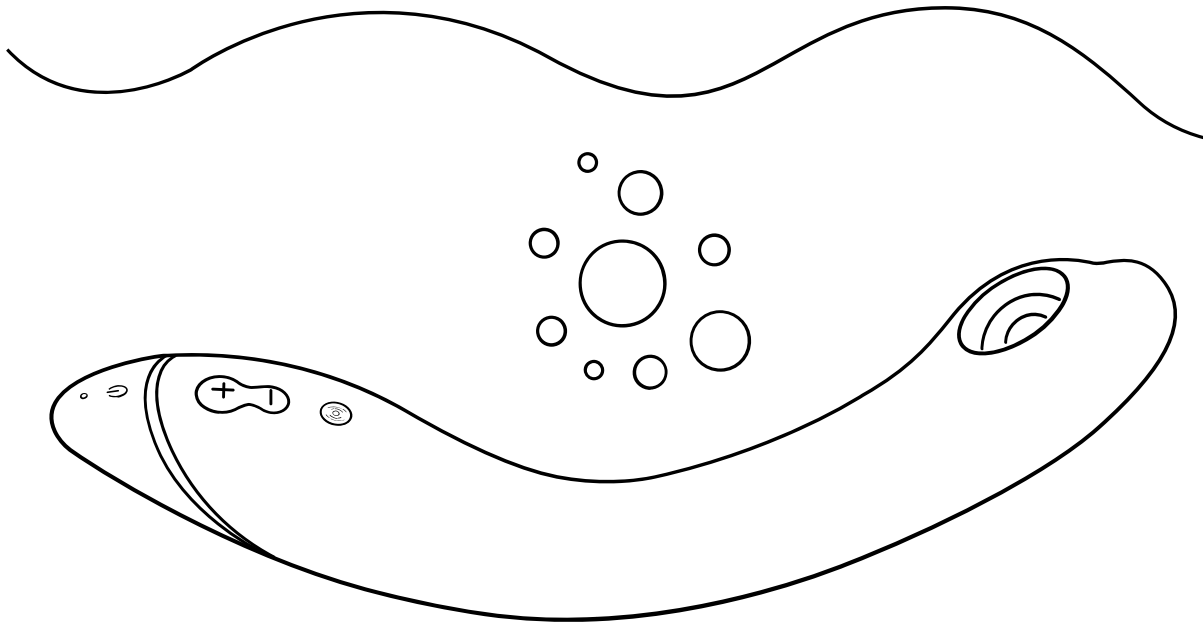

トイクリーナーを塗布します。

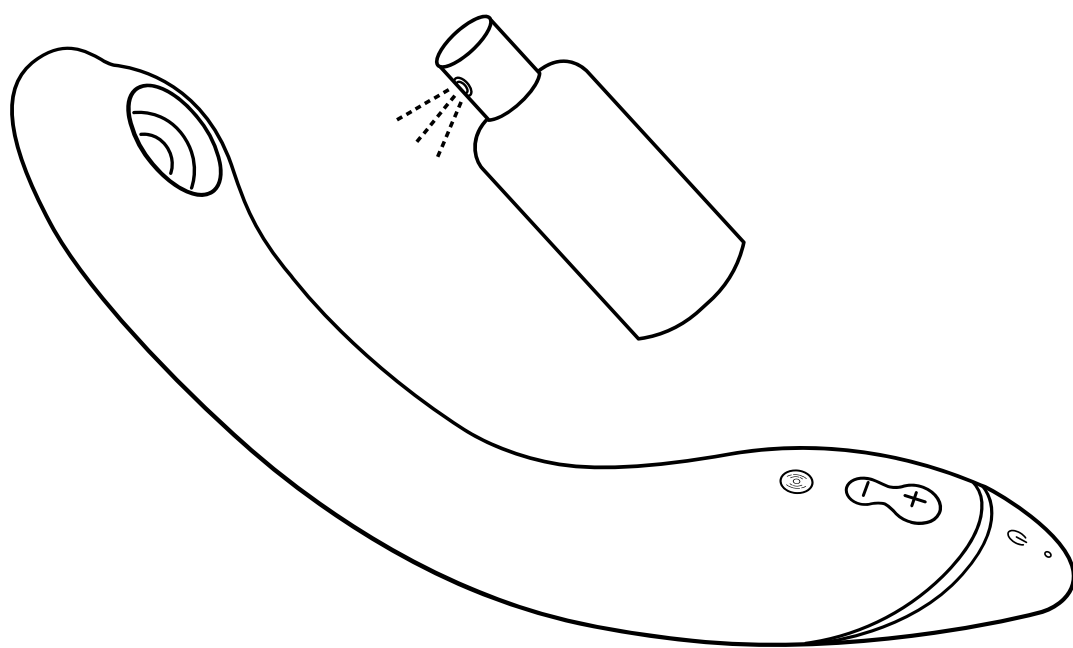

メンブレンに圧力をかけすぎないように注意して乾かします。

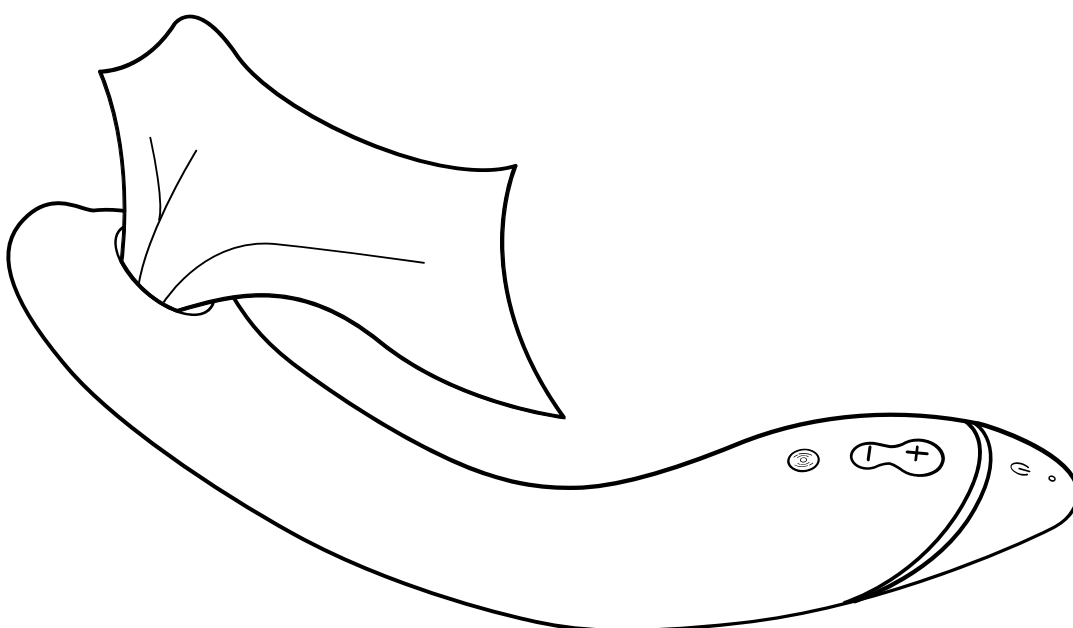

防水加工 (IPX7)

# 充電

初めてお使いになる前に、**OG**を充電してください。バッテリーの寿命を延ばすために、**OG**を定期的に充電してください。

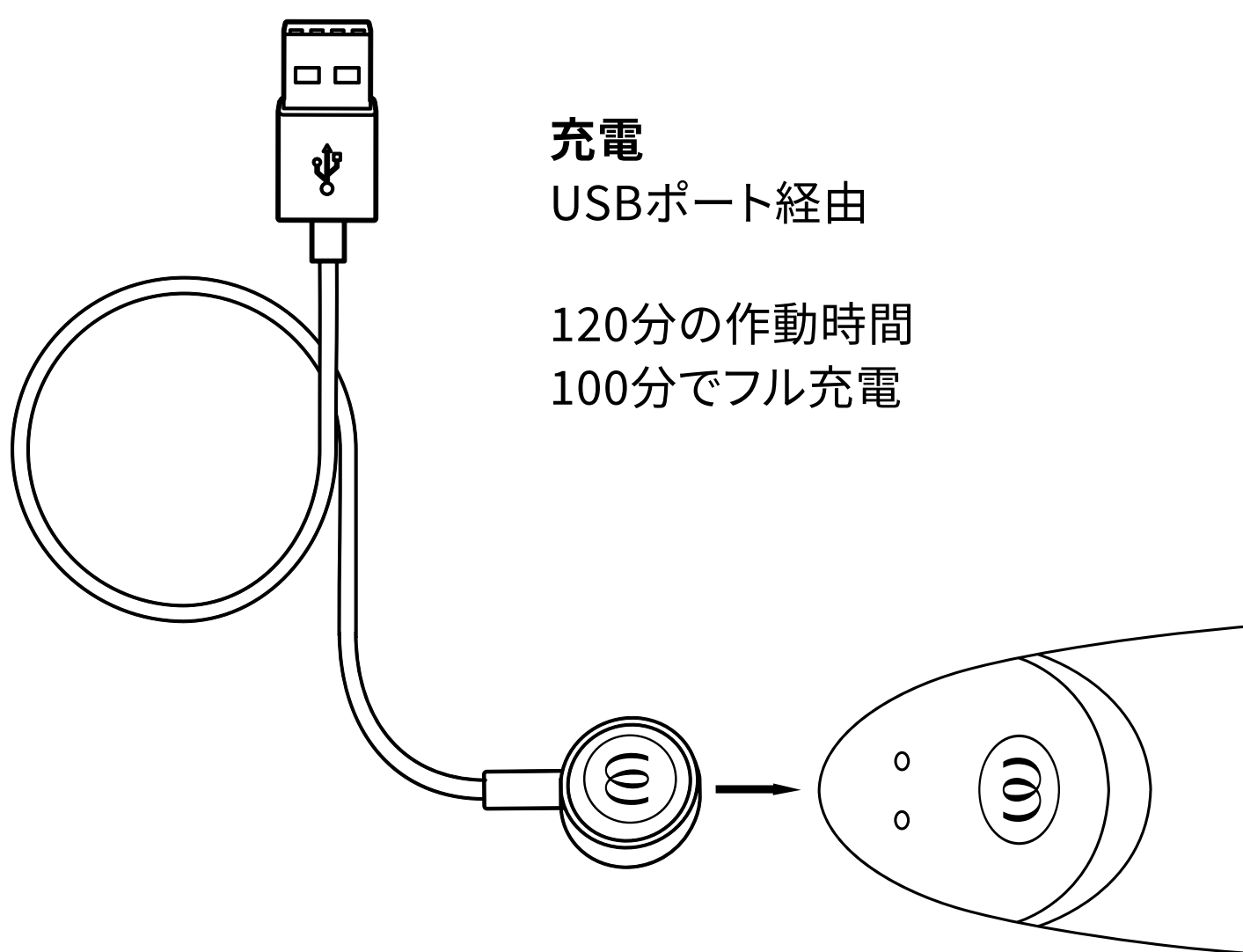

## 充電

USBポート経由

120分の作動時間

100分でフル充電

---

## LED

オン/オフ/充電中

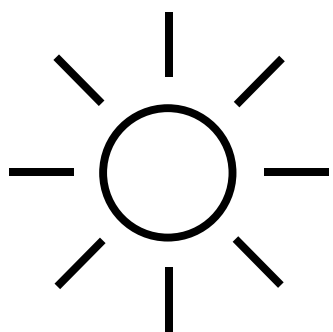

**フル充電**  
LEDが連続点灯

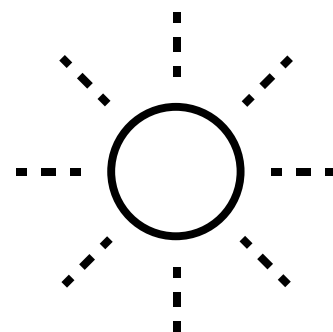

**充電**  
LEDが点滅

# WOMANIZER OGで快楽を心ゆくまでお楽しみいただくためのヒント



Gスポットの「G」は、医師のエルンスト・グレーフェンバーグにちなんで名付けられました。名前は定着していますが、Gスポットはスポットではありません。膣の内側から刺激できる、クリトリス内の大きな空間であることがわかっています。

つまり、Gスポットは膣の前壁で覆われているため、露出している外側のクリトリスよりも敏感ではないことがわかっています。

Gスポットは覆われているため、性感を高めるまでに多少時間がかかります。ただ、高まるにつれより大きくなり、より敏感になり、刺激をより感じられるようになります。

Gスポットは覆われているため、性感を高めるまでに多少時間がかかります。ただ、高まるにつれより大きくなり、より敏感になり、刺激をより感じられるようになります。

# 経験

ですから、好奇心を持ちつづけながら、時間をじっくりかけましょう。

**OG**の本体に水性潤滑ジェルを塗ります。



ムードを上げて、Pleasure Airの外部刺激機能で刺激します。



次に、バイブレーションを組み合わせたPleasure Airの内部刺激機能を使用します。



**OG**で、Pleasure Airの刺激機能と強力な振動をお楽しみいただけます。さまざまな強度と振動ムードを試して、オーガズムを味わえるように試行錯誤してみてください。

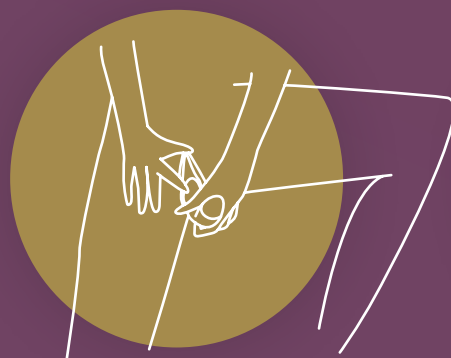
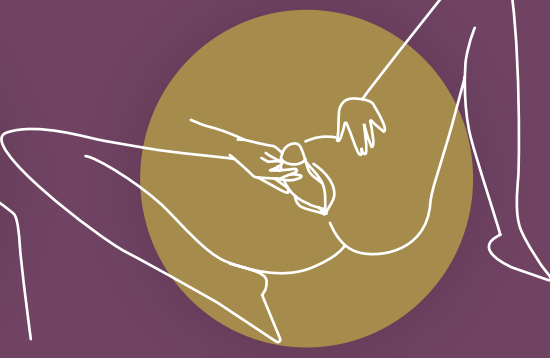
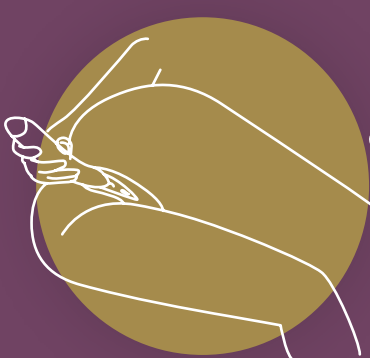



# SAFETY INFORMATION

## 警告

ノベルティ商品としてのみ販売。使用目的に準拠して、製品を使用してください。本製品はお子さまの手の届かないところに保管してください。医療用には適していません。現在医師による治療を受けている方や、医療機器の使用を必要とする疾患がある方は、本製品のご使用前に、担当医にご相談ください。皮膚の刺激、痛み、または不快感を感じた場合は、本製品の使用を直ちに中止し、担当医にご相談ください。

この器具は、成人のみを対象としています。また、身体的、感覚的、精神的能力に制限があったり、経験や知識が不十分な人物の場合、安全に器具を使用し、危険を理解するための監視および指導のもと、使用するようにしてください。この器具は、お子様の手の届かない場所に保管してください。洗浄およびユーザーメンテナンスは、必ず成人が行ってください。炎症やむくみのある肌には使用しないでください。

- 使用中にはピアスや装飾品を外してください。
- ご使用の前後には必ず、マニュアルに記載されている指示に従って、本製品のお手入れをしてください。
- 製品へのダメージを防ぐため、製品とその電池が45°Cを超える熱にさらされないようにしてください。また分解したり、機械的あるいは電気的な損傷を与えたりしないようにしてください。
- 性具を共有することにより、性感染症に感染する危険があります。性具は、パートナー以外の人物と、共有しないでください。パートナーと共に使用する際も、必要に応じて、保護措置を講じてください。性具のカバー素材にヒビや劣化がある場合は、性具を使用しないでください。
- 当製品は、アナルへの使用を想定して設計されていません。アナルには、使用しないでください。
- シミの付着を避けるため、製品の柔らかい部分を、吸収性のある表面に設置しないでください。
- 充電器と本製品にダメージがないか定期的にチェックし、何らかの損傷が構成部品にみられる場合は、機器の使用を停止してください。
- 磁場は、ペースメーカーなどの機械的および電子的コンポーネントに影響を与える可能性があります。ペースメーカーの真上でデバイスを使用しないでください。詳細については、かかりつけの医師にお問い合わせください。磁気ストライプのあるカード(クレジットカードなど)をデバイスの近くに持ち込まないでください。製品の磁石によって損傷する可能性があります。
- 本品に機能上の不具合がみられる場合は、電源を切って、当ウェブサイトのサポート部にお問い合わせください。

## 性具の充電

- 充電器を初めて使用する前に、地域の電圧レベルを確認してください。地域の電源電圧が、充電器の最大電源電圧を超えないようにしてください。
- 器具のマーキングに準拠した安全な低電圧で、器具に電力を供給してください。
- バッテリーの充電中は、製品を使用または清掃しないでください。
- 充電器や充電ケーブルを、水や他の液体に浸さないでください。
- この器具には、充電不可能なバッテリーが含まれています。
- 当製品には、充電可能なリチウムイオン電池が含まれています。
- 各充電プロセスの後に、回路から充電ケーブルを外します。

## 本製品を最適にお使いいただくため、以下のガイドラインを守ってください：

- 電池の寿命を長く保証するため、ご使用にならない場合でも、定期的に機器に充電してください。
- 安全で乾燥した、直射日光の当たらない場所に保管してください。
- 本製品を使用する場合は、水溶性の潤滑剤をご利用ください。ダメージを防ぐため、香料が使用されている、シリコン系またはアルコール系の潤滑剤、ジェル、またはマッサージオイルは、使用しないでください。



# GENERAL INFORMATION

## ELECTRICAL RATING

**Model:** OG

**Model No.:** TES10A

**Power Input:**

3,7 V=0,62 A: Built-in Li-Polymer rechargeable battery.

5 V=0,5 A: When charged using USB.

Use USB AC adaptor (not included) with power output corresponding to product rating. Use original provided cable only."

## CONTENT OF DELIVERY

Womanizer OG G-Spot vibrator, USB charging cable (AC adapter not included), cotton storage pouch, quick start guide, safety instructions

## ENVIRONMENTAL PROTECTION

As a distributor of electronic devices, we are legally obliged to accept the return of waste electrical and electronic devices free of charge. We expressly state that you as the user are legally obliged to return used batteries.

Never throw away electronic devices or batteries in the household waste. The symbol shown below (crossed-out wheeled bin) is intended to expressly remind you of this.

## MANUFACTURED AND DISTRIBUTED BY

**WOW Tech Europe GmbH**

Hermann-Blankenstein-Strasse 5

10249 Berlin

[www.wowtech.com](http://www.wowtech.com)

WOW Tech Europe GmbH reserves the right to make technical changes and changes to the design that serve to improve the device.

For information regarding patents see [womanizer.com/patents](http://womanizer.com/patents).

## CUSTOMER CARE

[care@womanizer.com](mailto:care@womanizer.com)

[womanizer.com](http://womanizer.com)

Designed in Germany. Made in China.

Date of issue: 10/2022.



# STILL WANT MORE?

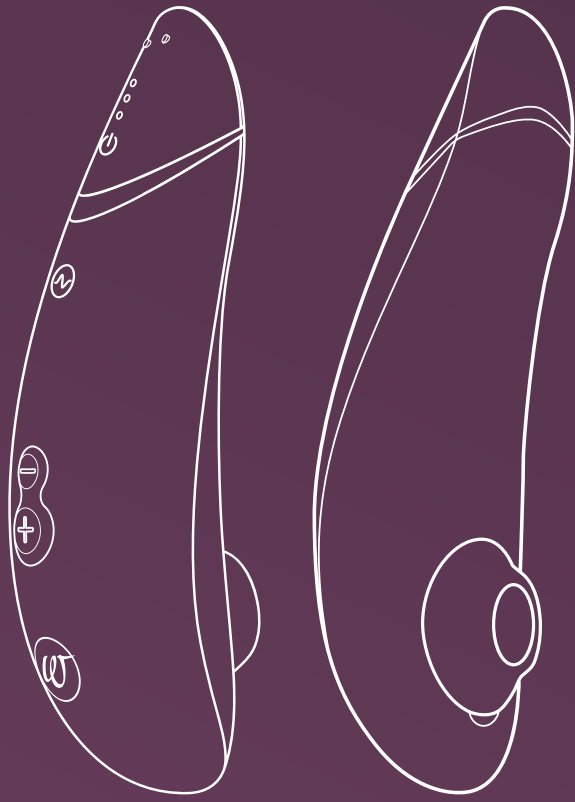

Pleasure Air  
Technology

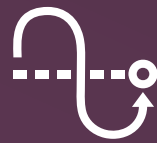

Autopilot



Smart Silence

**Premium 2**  
Define your luxury

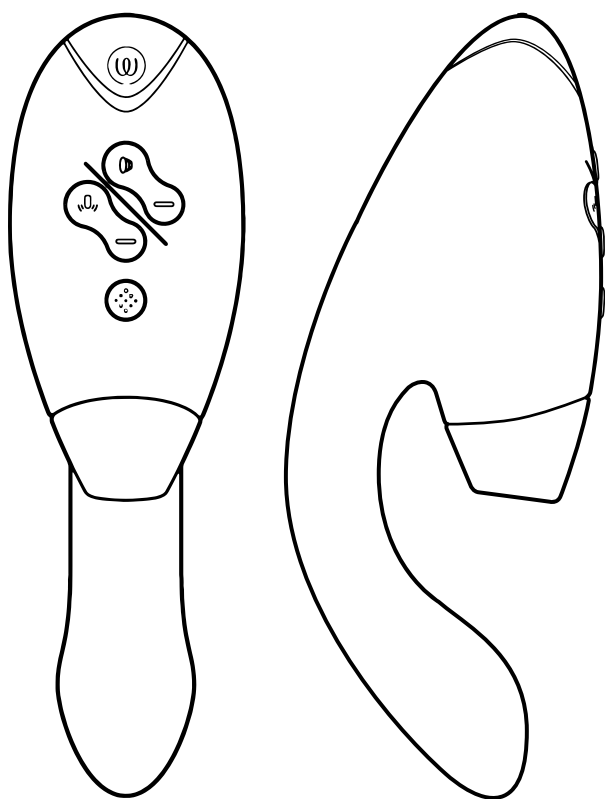

Pleasure Air  
Technology



Double Stimulation



Smart Silence

**DUO 2**  
Indulge in whole-body orgasms



#IMASTURBATE

# Hi!

Faleminderit që zgjodhët **WOMANIZER OG**.

Mirë se vini në një botë të mbushur me përvoja sensuale që do të përmirësojnë jetën tuaj. Duke zgjedhur **WOMANIZER**, jo vetëm që ju garantohen orgazma të pakrahasueshme – por edhe një epsh krejtësisht i ri për kënaqësi.

Shijoni pajisjen tuaj **WOMANIZER OG** - orgazma njëra pas tjetrës.

Duajeni veten tuaj!



**PËRSHKRIMI**

**MËNYRA E PËRDORIMIT**

**SMART SILENCE**

**PASTRIMI**

**KARIKIMI**

**SAFETY INSTRUCTIONS**

**INFORMACION I PËRSGJITHSHËM**

Please read the safety instructions in the  
Compliance & Safety Information before first use.

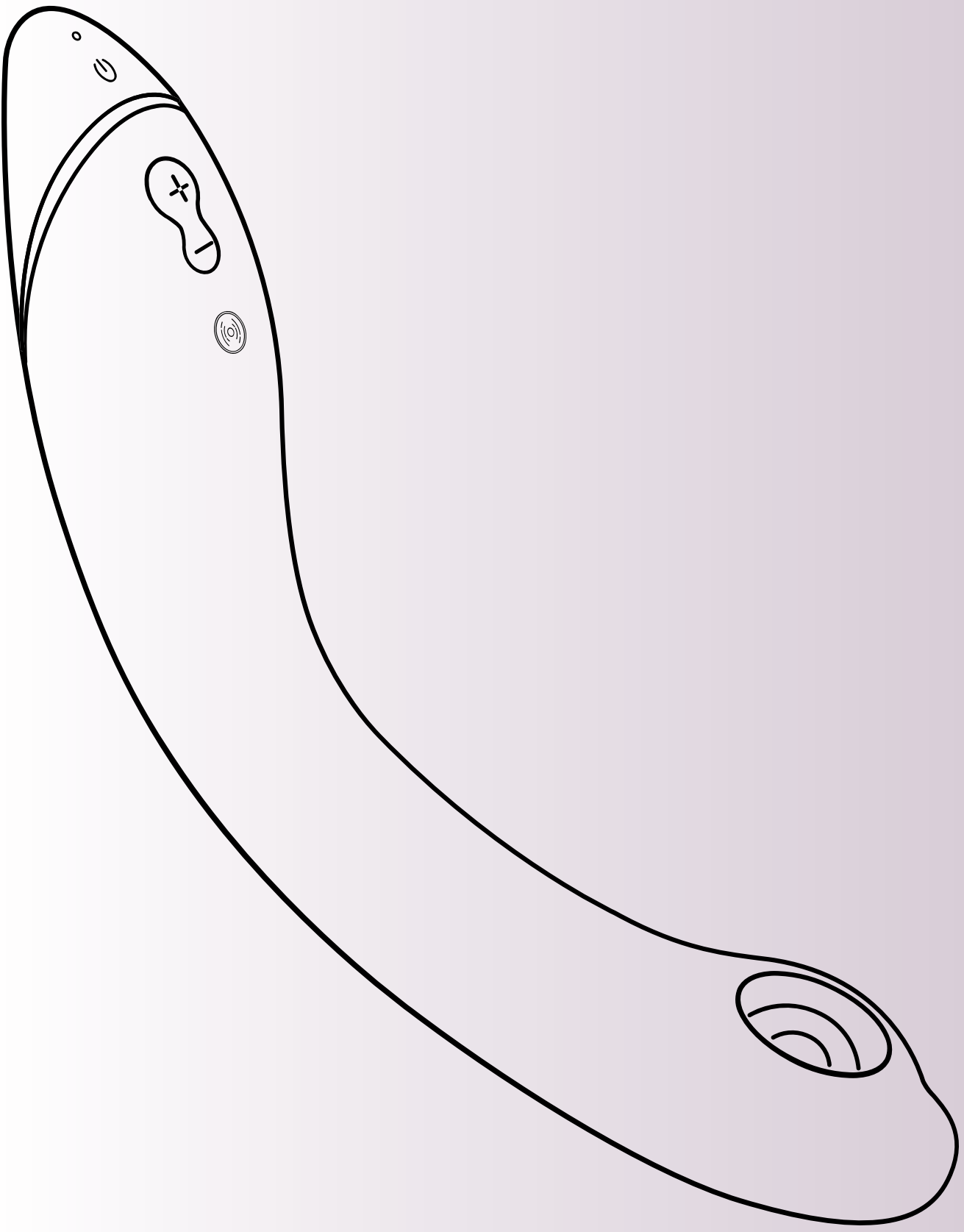

# PËRSHKRIMI

**Ekрани LED**  
Ndezja/Karikimi

**Aktivizimi/çaktivizimi  
i "Smart Silence"**  
Shtype për 2 sekonda

**Dridhja**  
Shtyp shkurtimisht  
për të aktivizuar  
dhe rritur intensitetin  
(3 nivele)

**Pleasure Air Technology**  
(12 nivele)

**Ndezja/Fikja**  
Shtype për 2 sekonda

**Rritja e intensitetit**  
Shtyp (+) për pak çaste

**Ulja e intensitetit**  
Shtyp (-) për pak çaste

**Afterglow**  
Shtyp (-) për 1 sekondë



# MËNYRA E PËRDORIMIT

## 1. Ndezja

Shtype për 2 sekonda.  
Drita LED tregon se  
produkti është i ndezur.

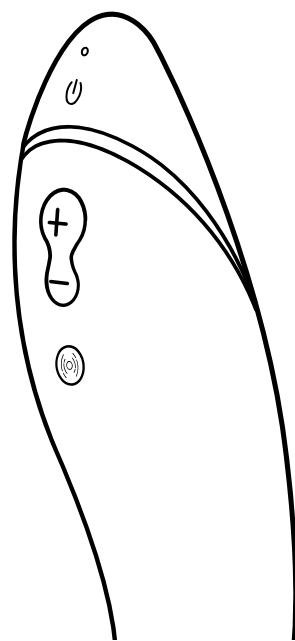

## 2. Përdorimi

Për të ardhur në humor,  
fillimisht përdoreni **OG**  
në klitorisin tuaj.

Shtoni lubrifikues me bazë  
uji në trupin e **OG**.

Kur të keni ardhur në qejf,  
futni **OG** dhe eksploroni pikën  
tuaj G!

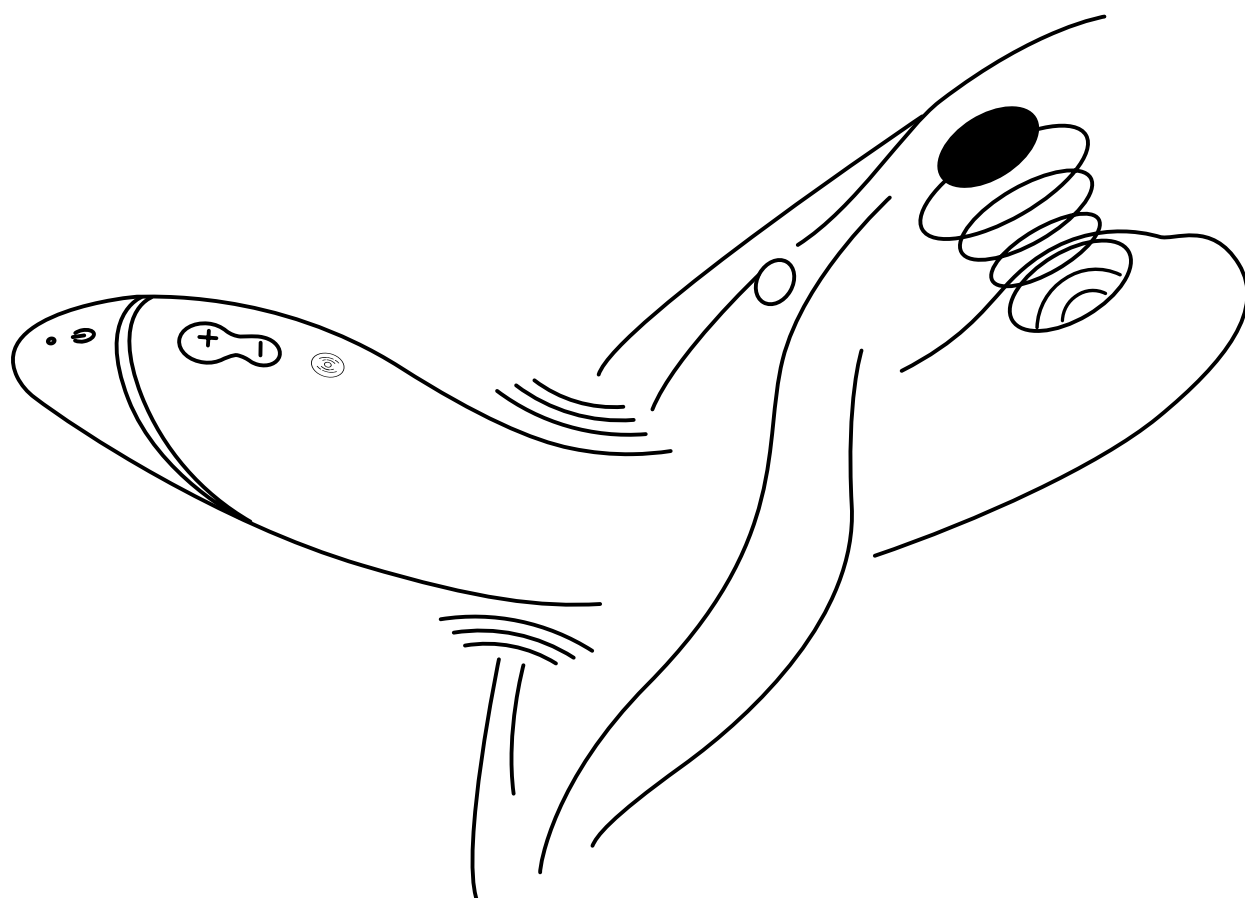
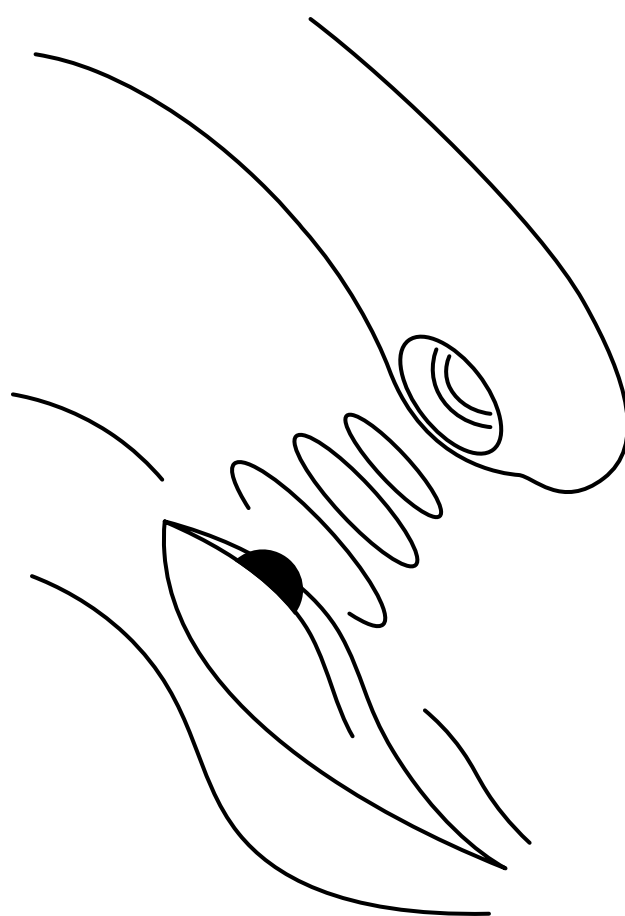



# MËNYRA E PËRDORIMIT

## 3. Ndryshimi i intensitetit

### Rritja

Shtyp shkurtimisht  
**12 nivele intensiteti**

### Rritja

Shtyp shkurtimisht  
**3 nivele dridhjeje**

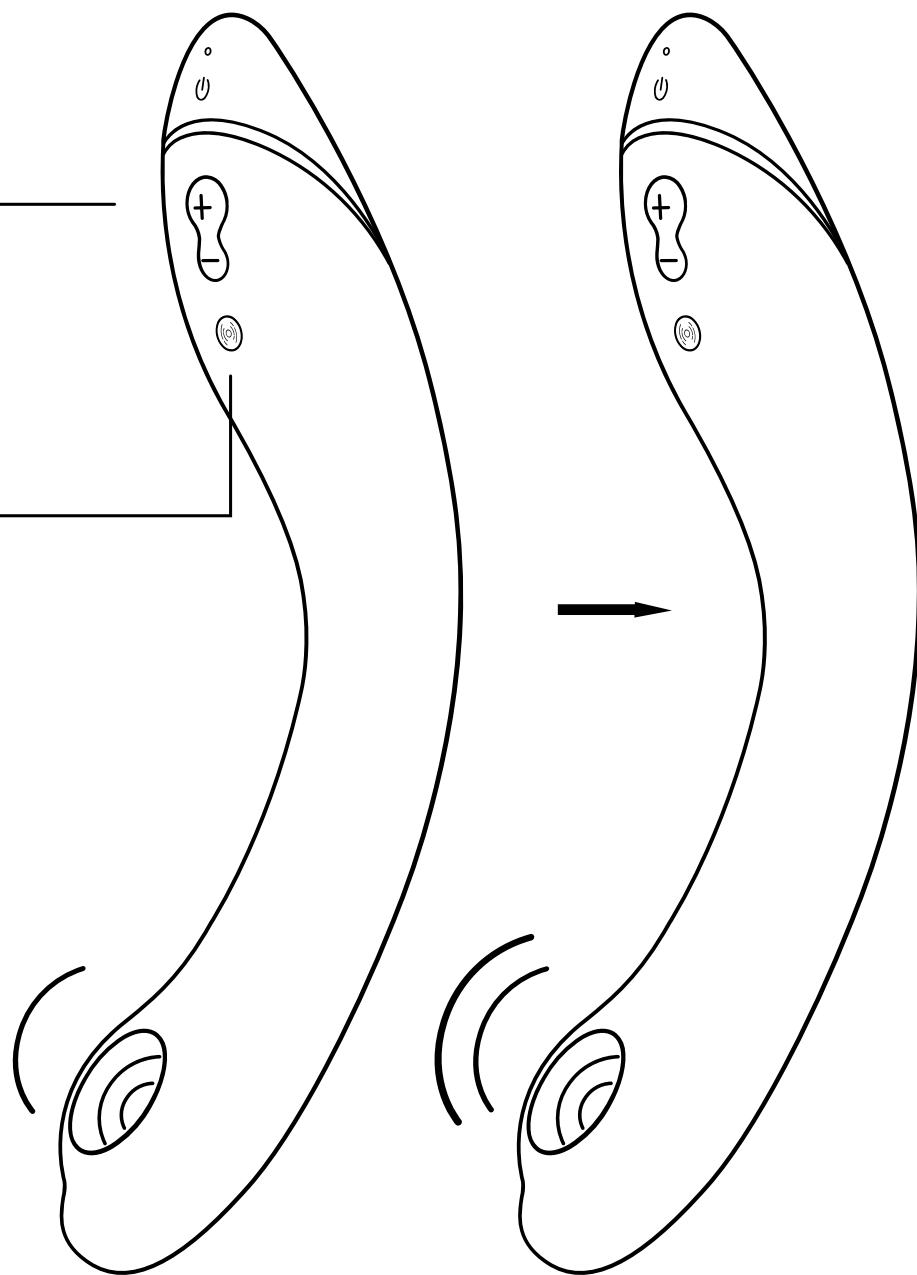

### Ulja

Shtyp shkurtimisht

### Afterglow

Shtyp (-) për 1 sekondë  
për t'u kthyer në nivelin  
1 të intensitetit.

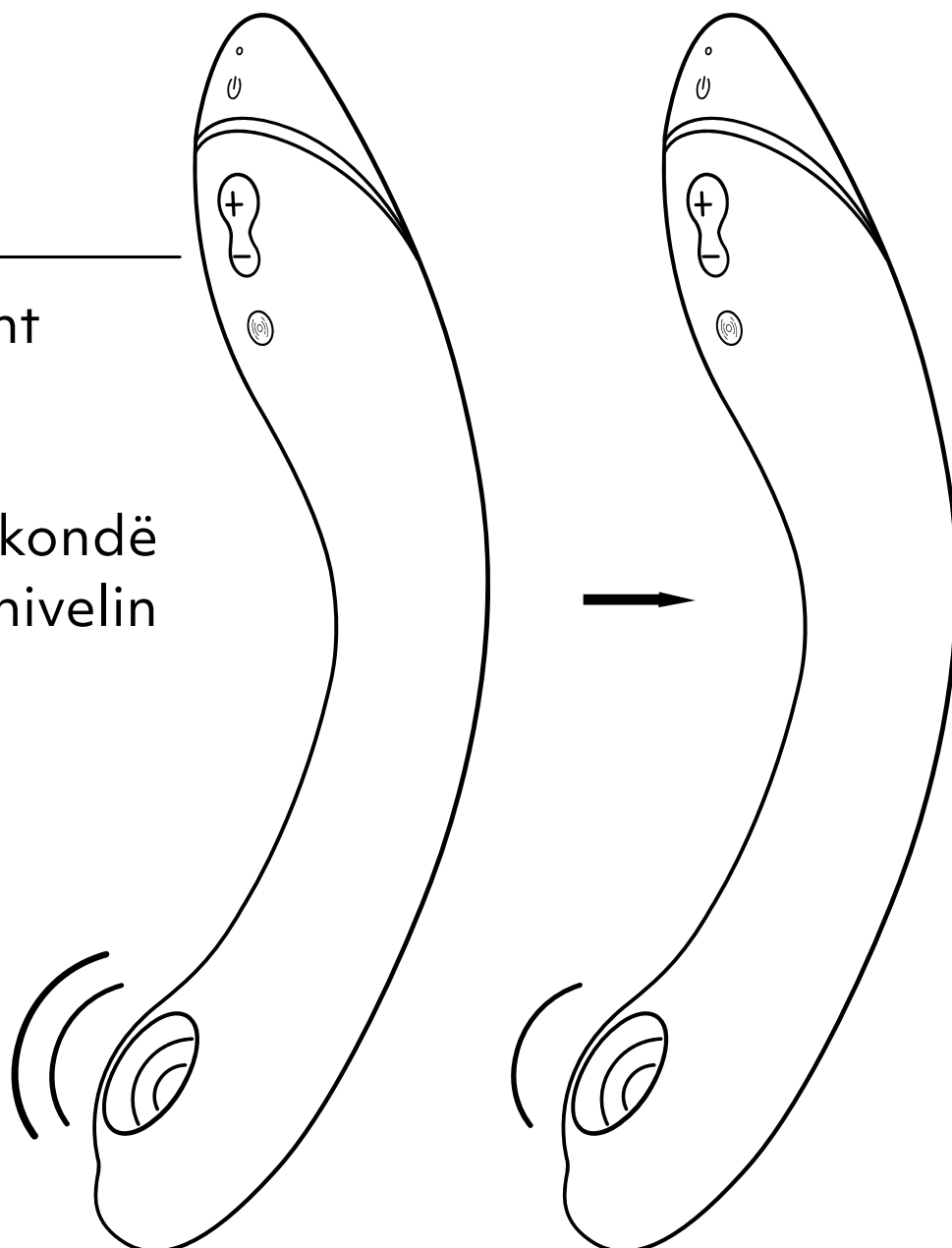

# MËNYRA E PËRDORIMIT

4. **Fikja** —————  
Shtype për 2 sekonda

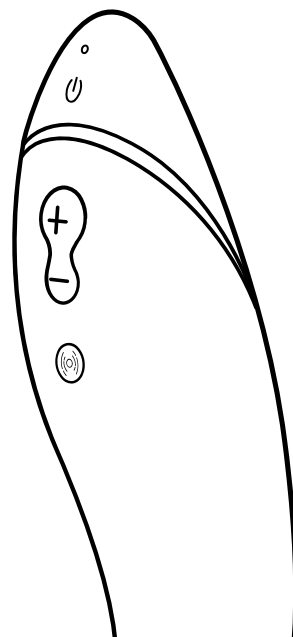

## SMART SILENCE

**OG** ndizet vetëm kur është gati duke prekur lëkurën tuaj. “Smart Silence” aktivizohet si parazgjedhje. Shtypni dhe mbani shtypur butonat plus dhe minus për 2 sekonda për të aktivizuar ose çaktivizuar “Smart Silence”.

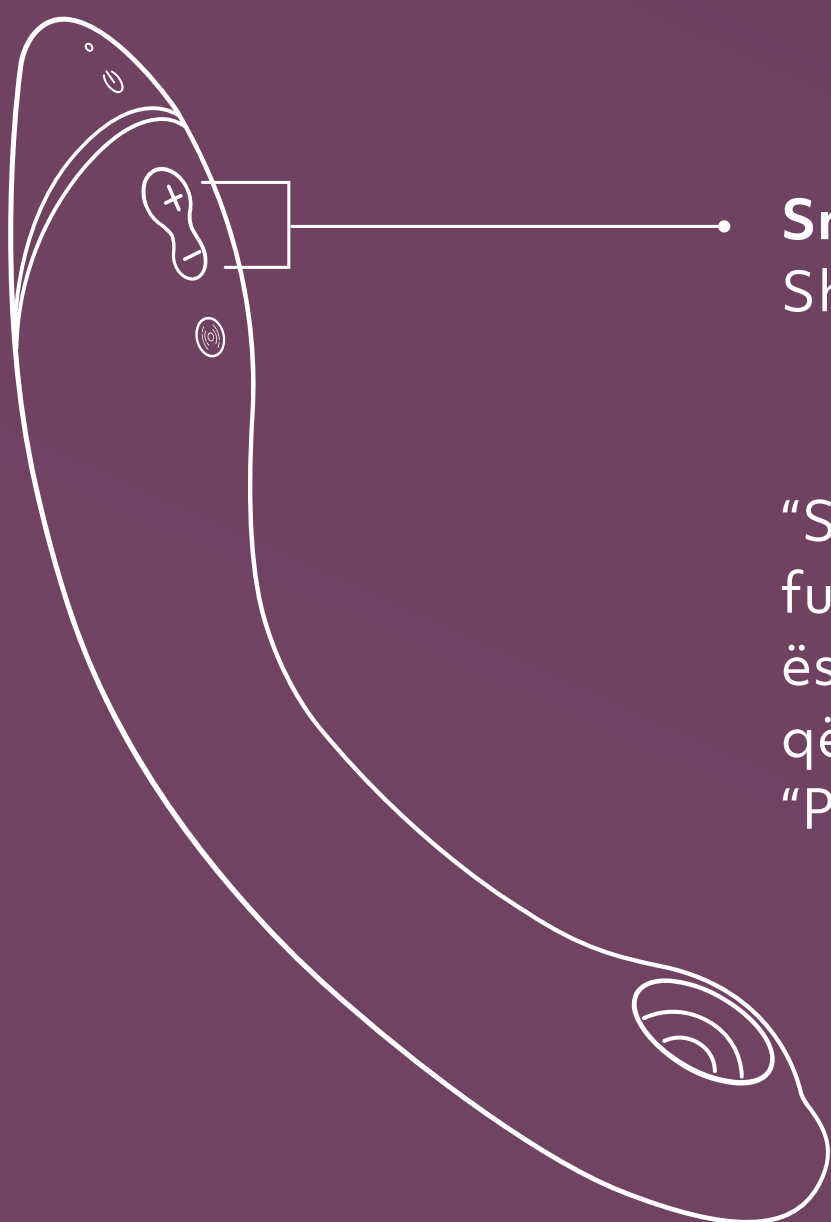

**Smart Silence Ndezja/Fikja**  
Shtype për 2 sekonda

“Smart Silence” mund të mos funksionojë kur koka e stimulimit është e lagur. Prandaj, sigurohuni që të mos aplikoni vaj në kokën e “Pleasure Air”.

# PASTRIMI

Lajeni me ujë.

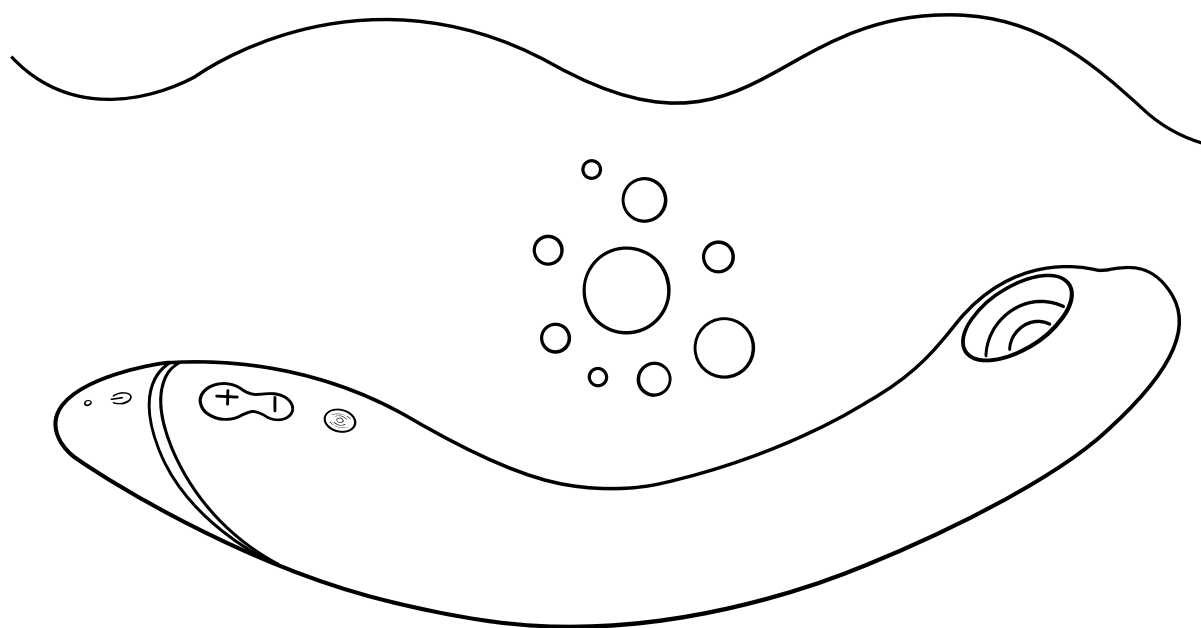

Aplikoni pastrues për lodrat e seksit.

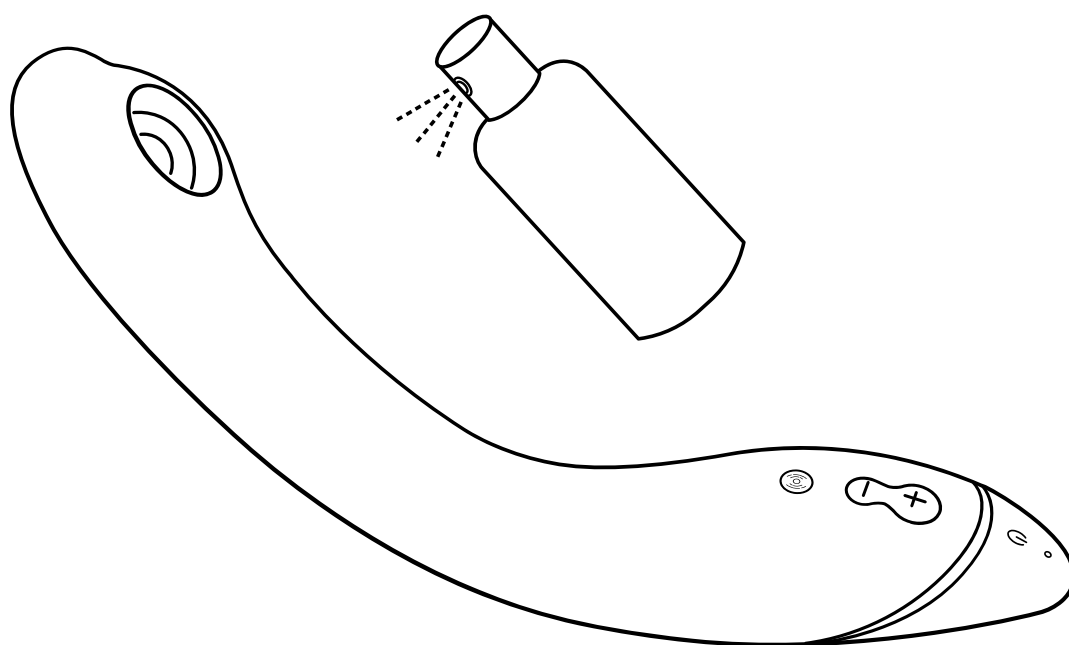

Thajeni me kujdes pa ushtruar tepër presion në membranë.

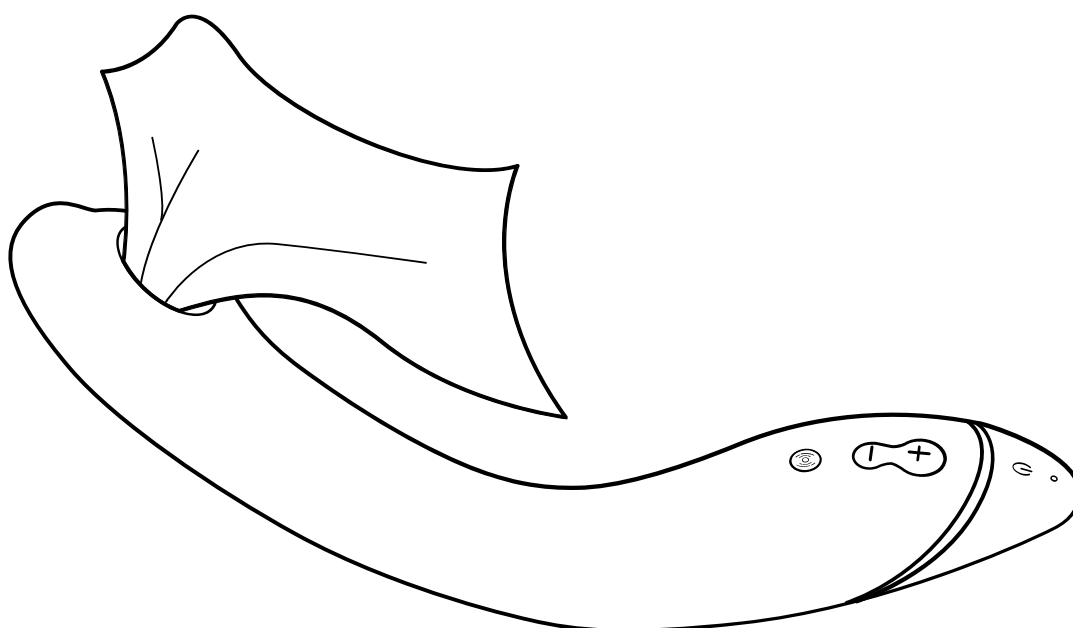

Rezistent ndaj ujit  
(IPX7)

# KARIKIMI

Karikojeni **OG**-në përpara përdorimit të parë. Gjithashtu mos harroni ta rikarikoni **OG**-në rregullisht, për të siguruar jetëgjatësi të baterisë.

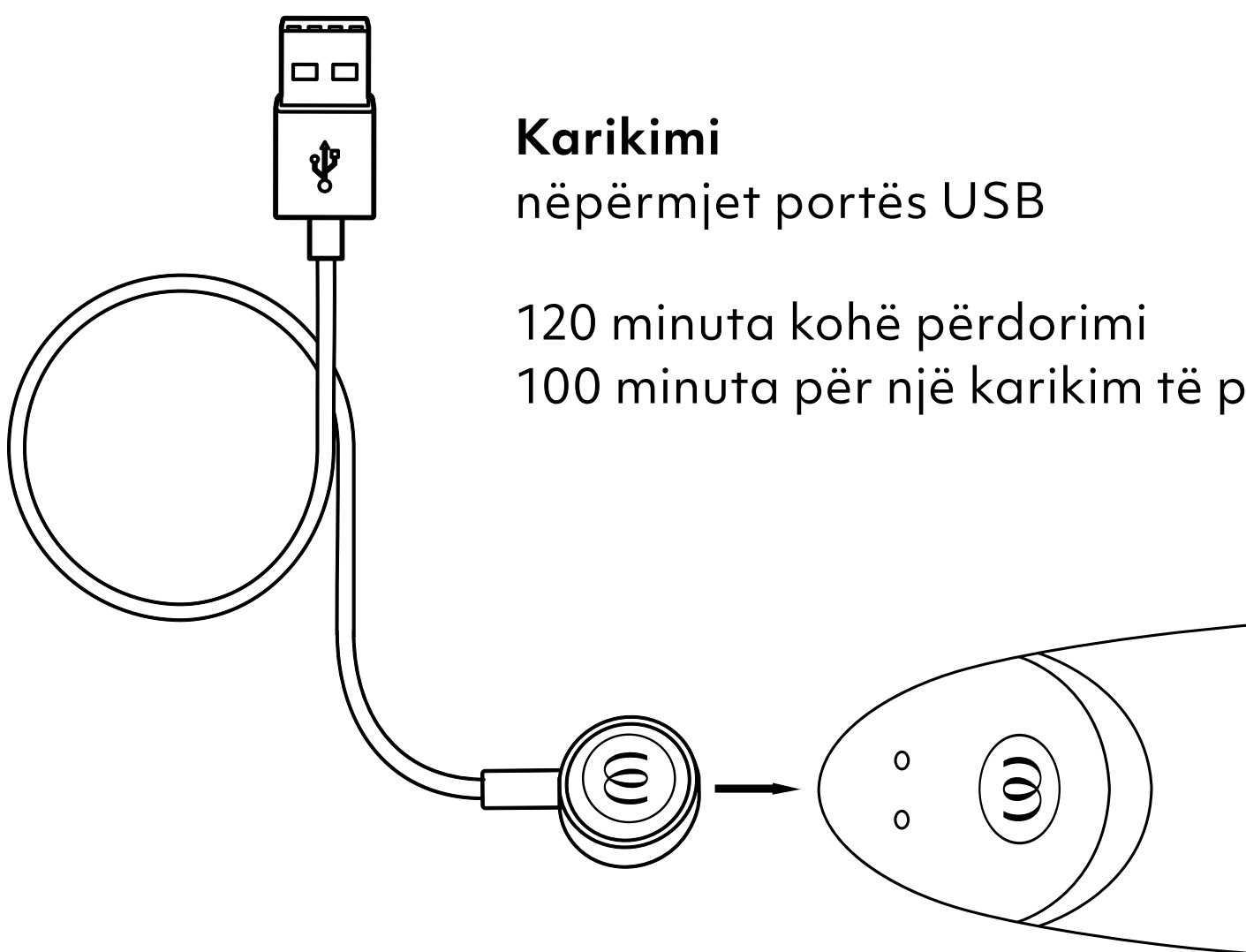

## Karikimi

nëpërmjet portës USB

120 minuta kohë përdorimi

100 minuta për një karikim të plotë

## LED

Ndezur/Fikur/duke u karikuar

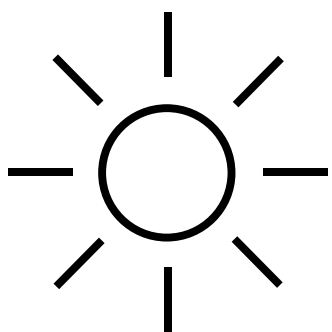

### Plotësisht i karikuar

Drita LED ndizet vazhdimisht

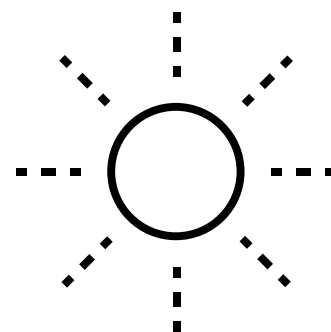

### Karikimi

Drita LED pulson

# SAFETY INSTRUCTIONS

## PARALAJMËRIM

Shitet vetëm si produkt novator. Përdoreni produktin vetëm për qëllimin e synuar. Mbajeni produktin larg fëmijëve. Nuk është i përshtatshëm për qëllime mjekësore. Nëse jeni nën kujdesin e një mjeku dhe/ose keni një gjendje mjekësore që kërkon përdorimin e ndonjë pajisjeje mjekësore, ju lutemi këshillohuni me mjekun përpara se ta përdorni këtë produkt. Ndalonni menjëherë përdorimin e produktit nëse keni irritime të lëkurës, dhimbje ose shqetësim dhe këshillohuni me mjekun.

Ky produkt mund të përdoret vetëm nga të rritur dhe nga persona me aftësi të reduktuara fizike, ndijore ose mendore ose me mungesë përvojë dhe njohurie nëse mbikëqyren ose udhëzohen lidhur me përdorimin e produktit në mënyrë të sigurt dhe nëse i kuptojnë rreziqet e përfshira. Nuk lejohet që fëmijët të luajnë me produktin. Pastrimi dhe mirëmbajtja nuk duhet të kryhen nga fëmijët. Mos e përdorni në pjesë të ënjtura ose të pezmatuara të lëkurës.

- Hiqni piercing ose stolitë në zonën gjenitale para përdorimit.
- Pastrojeni gjithmonë produktin përpara dhe pas përdorimit sipas udhëzimeve të dhëna në manual.
- Për të shmangur dëmtimin e produktit, produkti dhe bateria e tij nuk duhet të ekspozohen në temperatura mbi 45°C, të çmontohen apo të dëmtohen mekanikisht ose elektrikisht.
- Ndarja e lodrave seksuale me persona të tjerë mund të çojë në transmetimin e sëmundjeve seksuale. Mos i ndani lodrat seksuale me persona të tjerë përveç partnerit tuaj. Përdorni masa mbrojtëse me partnerin nëse është e nevojshme. Mos e përdorni lodrën nëse vëreni ndonjë plasaritje apo shenjë degradimi në materialin mbulues.
- Ky produkt nuk është menduar për përdorim anal. Mos e përdorni në rrugë anale!
- Për të shmangur njollat, mos e vendosni anën e butë të produktit mbi një sipërfaqe përthithëse.
- Kontrolloni rregullisht pajisjen e karikimit dhe produktin për dëmtim dhe mos e përdorni pajisjen nëse është dëmtuar ndonjë komponent.
- Fushat magnetike mund të ndikojnë komponentët mekanikë dhe elektronikë, si p.sh. stimuluesit kardiakë. Mos e përdorni pajisjen direkt mbi një stimulues kardiak. Për më shumë informacion, kontaktoni mjekun. Mbajini larg produktit kartat me vija magnetike (p.sh. kartat e kreditit), pasi ato mund të dëmtohen nga magneti i produktit.
- Nëse produkti shfaq shenja funksionimi jonormal, fikenit dhe këshillohuni me seksionin e mbështetjes në faqen tonë të internetit.

## KARIKIMI

- Para se ta përdorni pajisjen e karikimit për herë të parë, kontrolloni nivelin e tensionit lokal, pasi tensioni i rrjetit nuk duhet të jetë më i lartë se tensioni maksimal elektrik që tregohet në pajisjen e karikimit.
- Produkti duhet të furnizohet me vetëm tension të sigurt tejet të ulët sipas shënimit në produkt.
- Mos e përdorni ose pastroni produktin gjatë karikimit të baterisë.
- Mos e zhytni kurrë pajisjen e karikimit ose kabllon e karikimit në ujë apo në lëngje të tjera.
- Ky produkt ka bateri që nuk mund të ndërrohen.
- Ky produkt ka një bateri të karikueshme me jone litiumi.
- Shkëputni kabllon e karikimit nga rrjeti elektrik pas çdo karikimi.

## PËR PËRDORIM OPTIMAL TË PRODUKTIT, JU LUTEMI NDIQNI UDHËZIMET E MËPOSHTME:

- Për të garantuar jetëgjatësinë e baterisë, ju lutemi karikojeni produktin rregullisht, edhe nëse nuk përdoret.
- Ruajeni në një vend të sigurt e të thatë, pa e ekspozuar në dritën e drejtpërdrejtë të diellit.
- Rekomandojmë që me produktin të përdorni lubrifikues me bazë uji. Për të parandaluar dëmtimin e produktit, mos përdorni lubrifikues të parfumuar, me bazë silikonit ose alkooli, xhel apo vajra masazhi.

# GENERAL INFORMATION

## ELECTRICAL RATING

**Model:** OG

**Model No.:** TES10A

**Power Input:**

3,7 V=0,62 A: Built-in Li-Polymer rechargeable battery.

5 V=0,5 A: When charged using USB.

Use USB AC adaptor (not included) with power output corresponding to product rating. Use original provided cable only."

## CONTENT OF DELIVERY

Womanizer OG G-Spot vibrator, USB charging cable (AC adapter not included), cotton storage pouch, quick start guide, safety instructions

## ENVIRONMENTAL PROTECTION

As a distributor of electronic devices, we are legally obliged to accept the return of waste electrical and electronic devices free of charge. We expressly state that you as the user are legally obliged to return used batteries.

Never throw away electronic devices or batteries in the household waste. The symbol shown below (crossed-out wheeled bin) is intended to expressly remind you of this.

## MANUFACTURED AND DISTRIBUTED BY

**WOW Tech Europe GmbH**

Hermann-Blankenstein-Strasse 5

10249 Berlin

[www.wowtech.com](http://www.wowtech.com)

WOW Tech Europe GmbH reserves the right to make technical changes and changes to the design that serve to improve the device.

For information regarding patents see [womanizer.com/patents](http://womanizer.com/patents).

## CUSTOMER CARE

[care@womanizer.com](mailto:care@womanizer.com)

[womanizer.com](http://womanizer.com)

Designed in Germany. Made in China.

Date of issue: 10/2022.



# STILL WANT MORE?

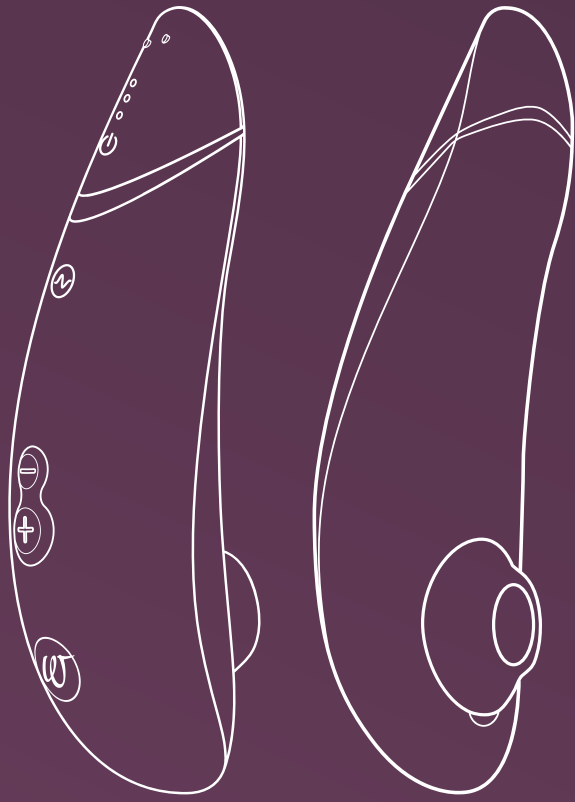

Pleasure Air  
Technology

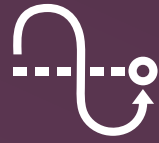

Autopilot



Smart Silence

**Premium 2**  
Define your luxury

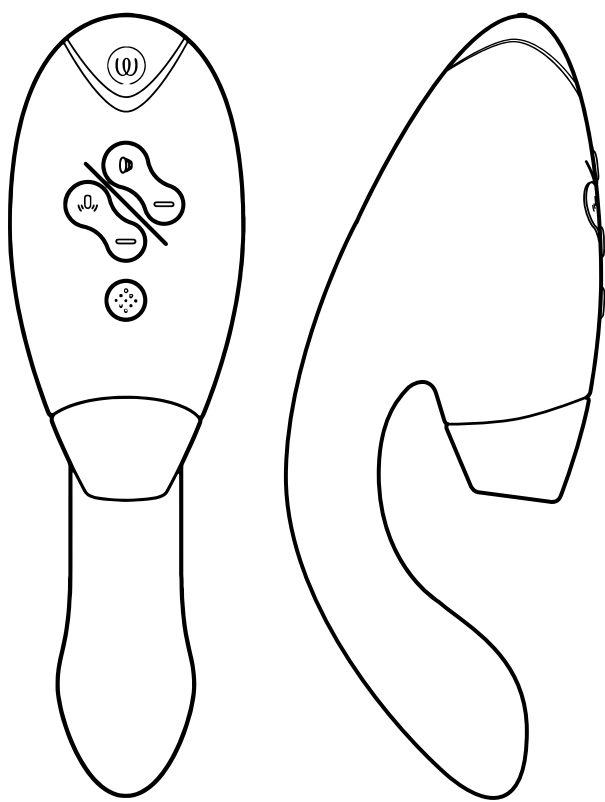

Pleasure Air  
Technology



Double Stimulation



Smart Silence

**DUO 2**  
Indulge in whole-body orgasms



#IMASTURBATE



# Hi!

Благодарим ви, че избрахте **WOMANIZER**

Добре дошли в свят, изпълнен с чувствени преживявания, които ще обогатят живота ви. Избирайки **WOMANIZER**, вие си гарантирате не само несравними оргазми, но и изцяло нова жажда за удоволствие.

Насладете се на своя **WOMANIZER** – оргазми един след друг.

Давайте, обичайте себе си!



ОПИСАНИЕ

НАЧИН НА УПОТРЕБА

СМАРТ ТИШИНА

ПОЧИСТВАНЕ

ЗАРЕЖДАНЕ

SAFETY INSTRUCTIONS

ОБЩА ИНФОРМАЦИЯ

Please read the safety instructions in the  
Compliance & Safety Information before first use.

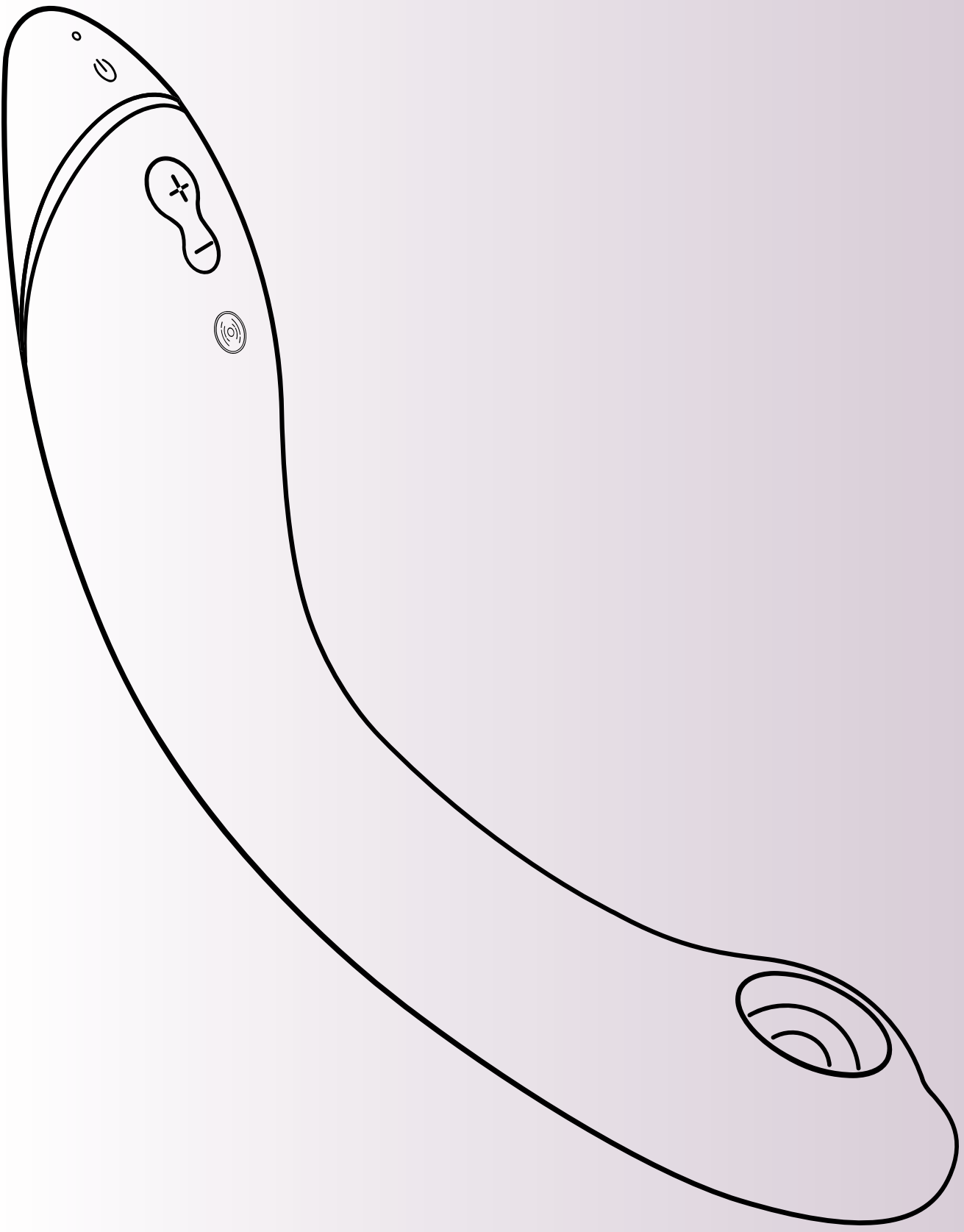

# ОПИСАНИЕ

**Светодиоден дисплей**  
Включено/Зареждане

**Включване/  
изключване на  
смарт тишинаумна  
тишина**  
Натиснете за 2  
секунди

**Вибрация**  
Натиснете леко,  
за да активирате  
и да увеличите  
интензитета

**Pleasure Air Technology**  
(12 нива на интензитет)

**Включване/  
Изключване**  
Натиснете за 2  
секунди

**Увеличаване на  
интензитета**  
Натиснете за кратко (+)

**Намаляване на  
интензитета**  
Натиснете за кратко (-)

**Остатъчно удоволствие**  
Натиснете (-) за 1  
секунда

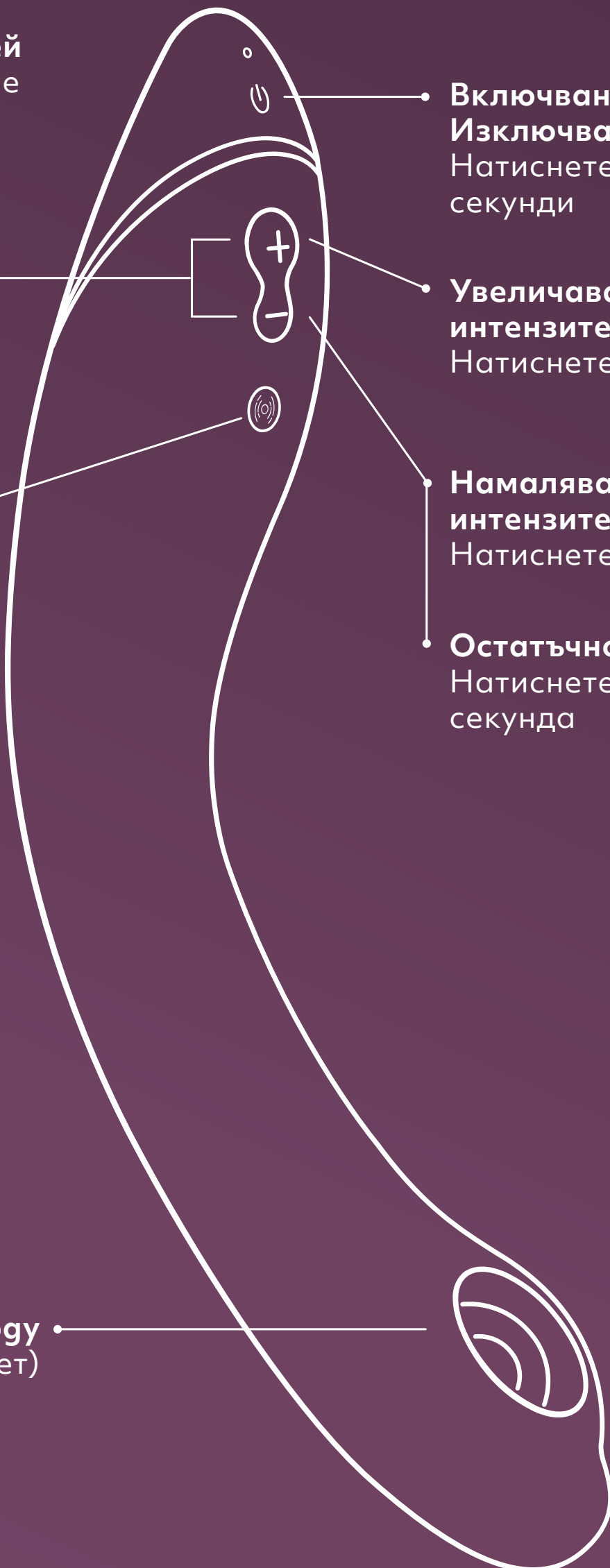

# НАЧИН НА УПОТРЕБА

## 1. Включване

Натиснете за 2 секунди  
Светодиодът ще укаже, че  
продуктът е включен.

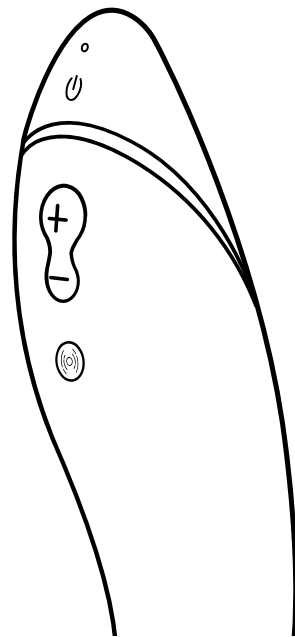

## 2. Употреба

За да си създадете  
настроение, използвайте  
**OG** първо върху клитора си.

Добавете лубрикант на водна  
основа към тялото на **OG**.

След като сте се разгрели,  
вкарайте **OG** и опознайте  
Г-точката си!

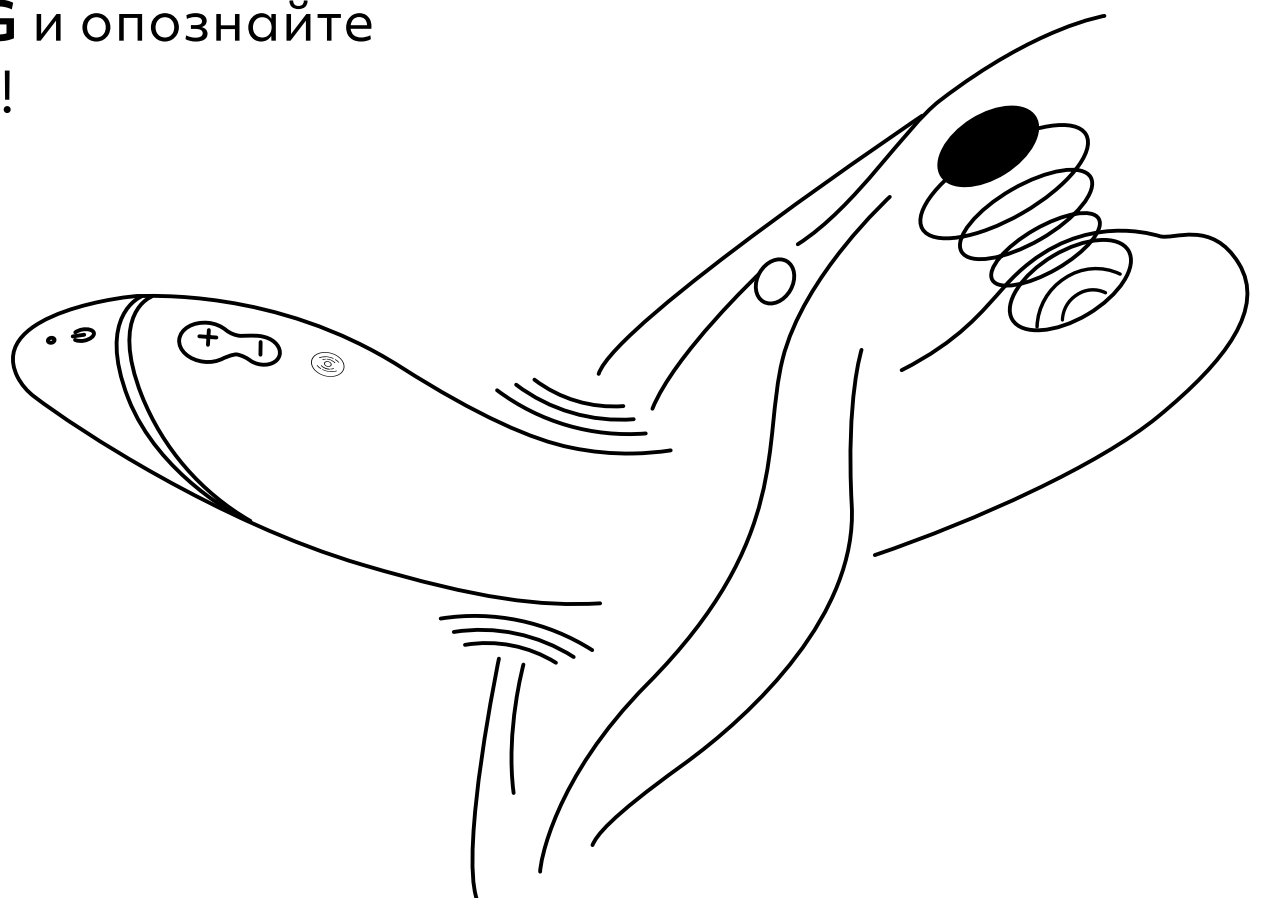
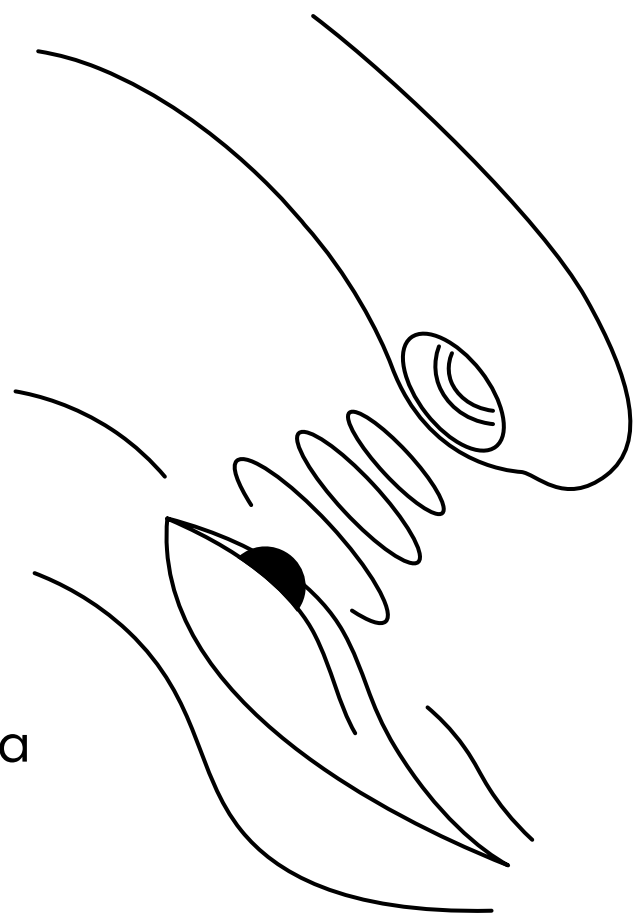

# НАЧИН НА УПОТРЕБА

## 3. Промяна на интензитета

**Увеличаване** —  
Натиснете за кратко  
**12 нива на интензитет**

**Увеличаване** —  
Натиснете за кратко  
**3 нива на вибрация**

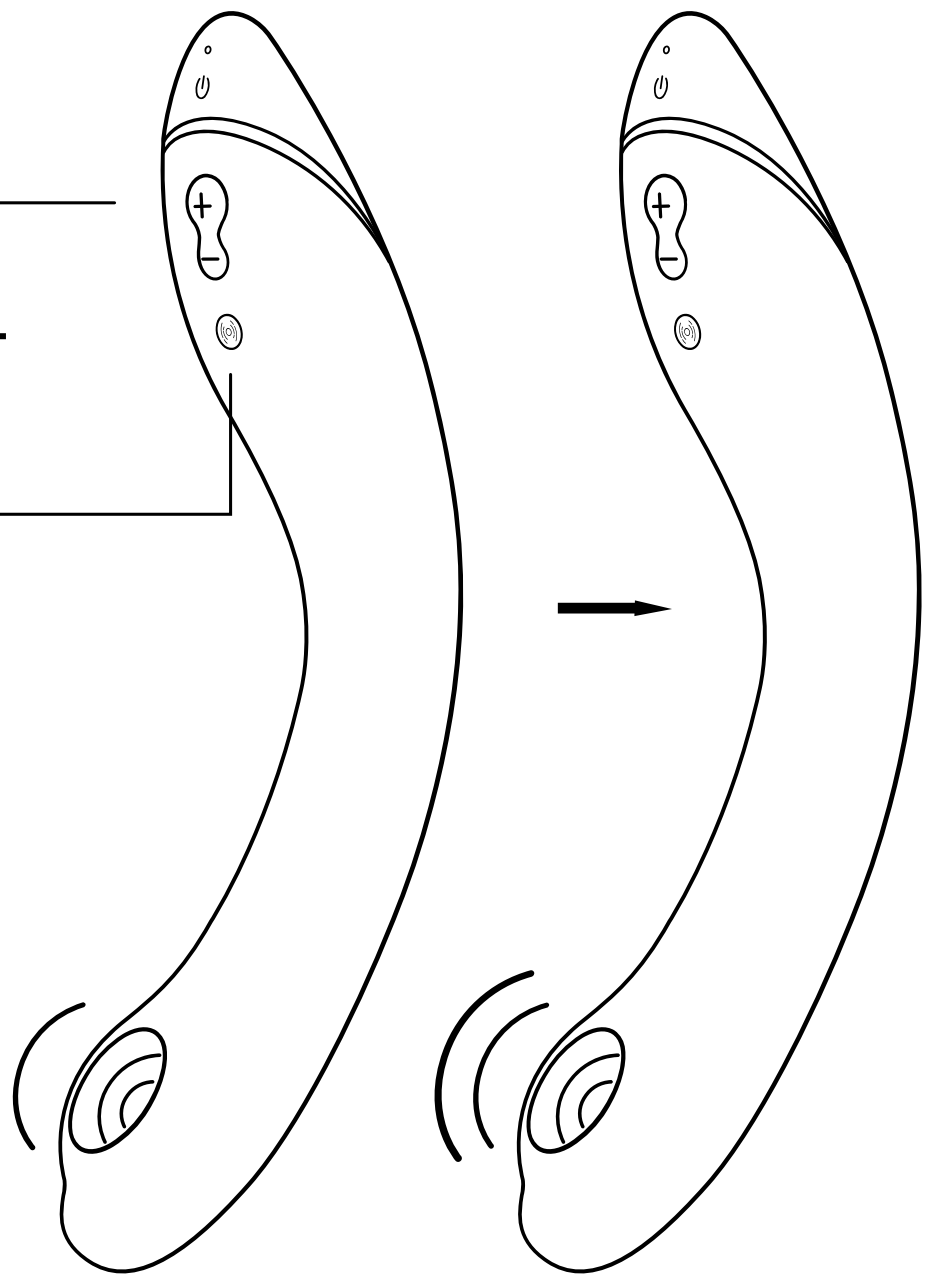

**Намаляване** —  
Натиснете за кратко

**Остатъчно  
удоволствие**  
Натиснете (-) за 1  
секунда, за да се  
върнете към ниво на  
интензитет 1

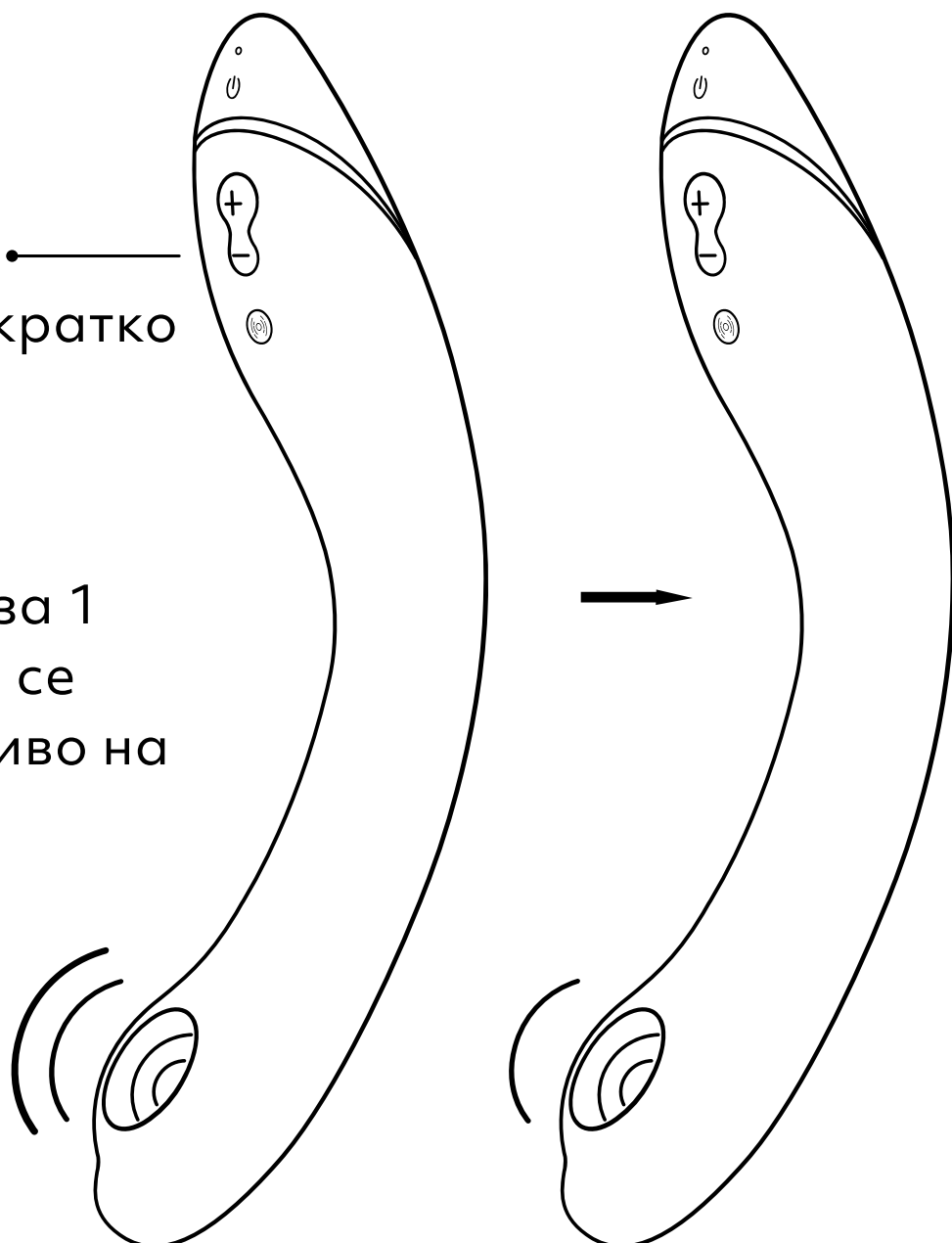

# НАЧИН НА УПОТРЕБА

## 4. Изключване

Натиснете за 2 секунди

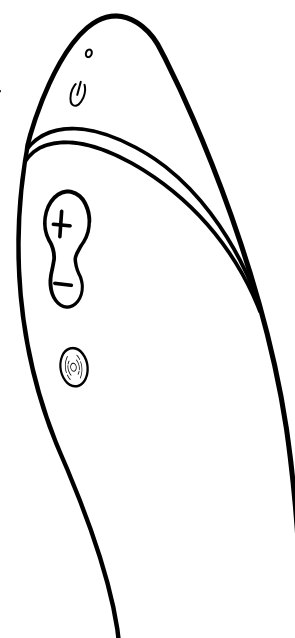

## СМАРТ ТИШИНА

**OG** се включва, когато почти докосва кожата ви. Смарт тишината е включена по подразбиране. Натиснете и задръжте бутоните с плюс и минус за 2 секунди, за да включите/изключите Смарт тишината.

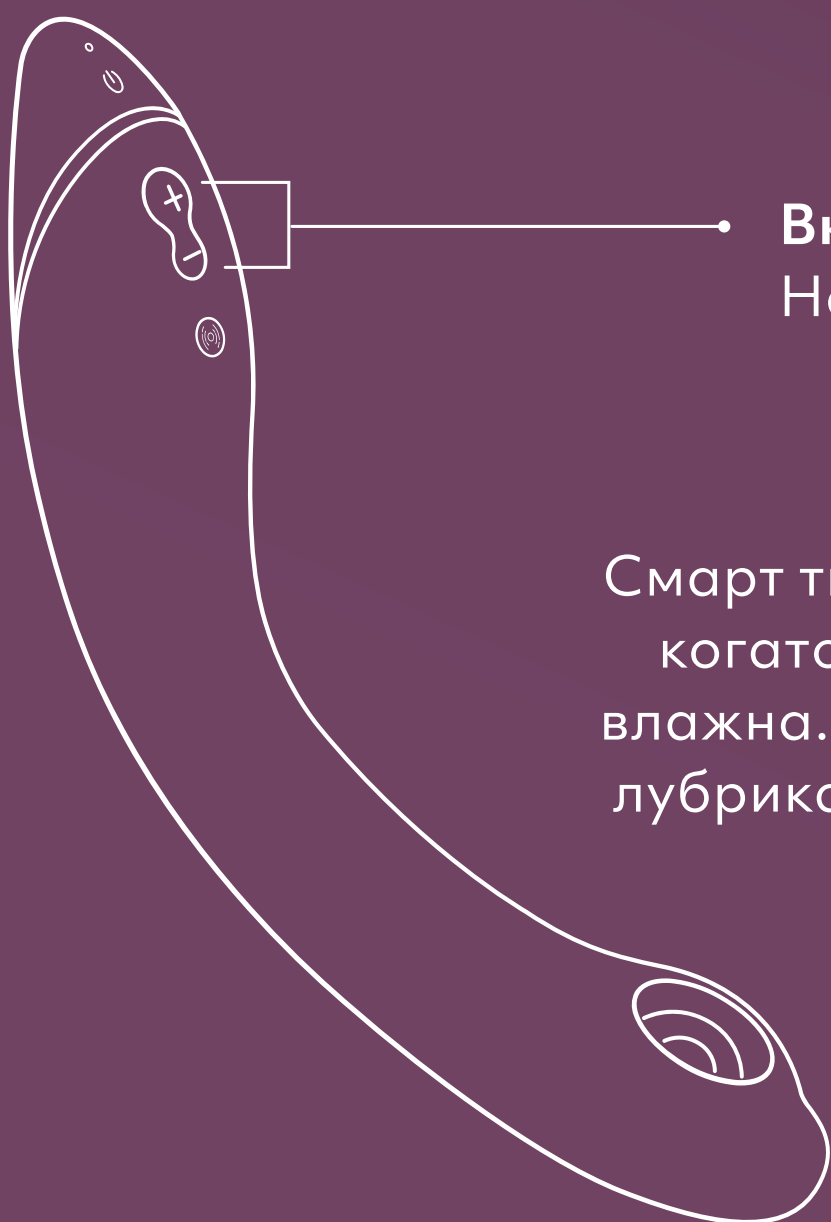

**Включване/Изключване**  
Натиснете за 2 секунди

Смарт тишината може да не работи, когато стимулационната глава е влажна. Следователно не нанасяйте лубрикант в главата на Pleasure Air.

# ПОЧИСТВАНЕ

Измивайте под вода.

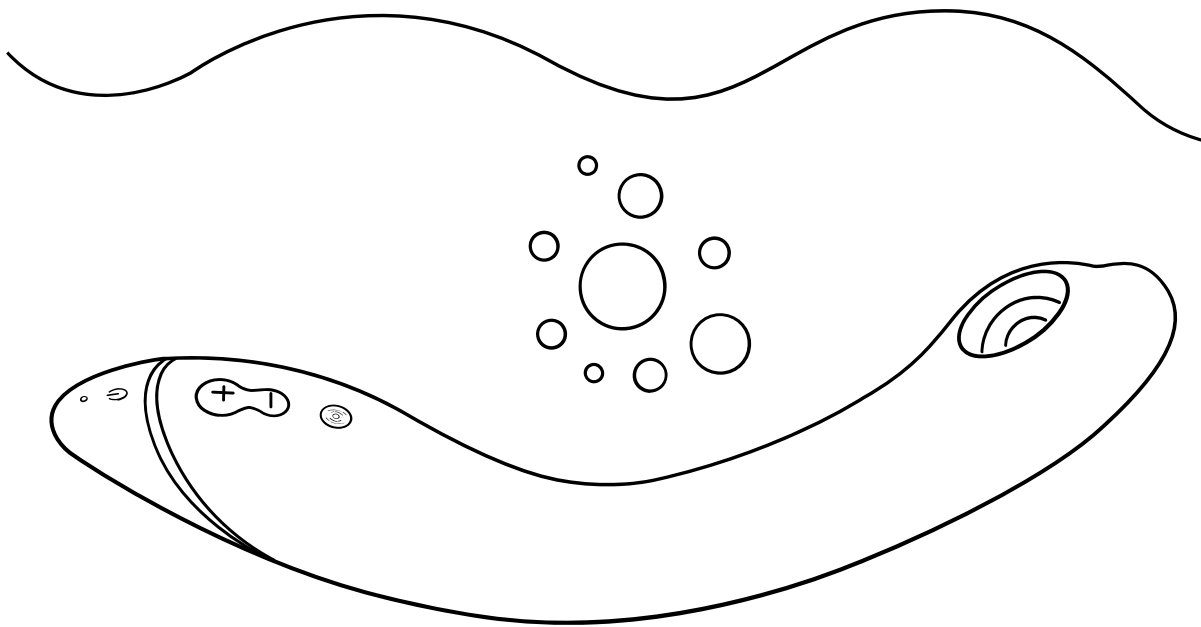

Прилагайте очистител за играчки.

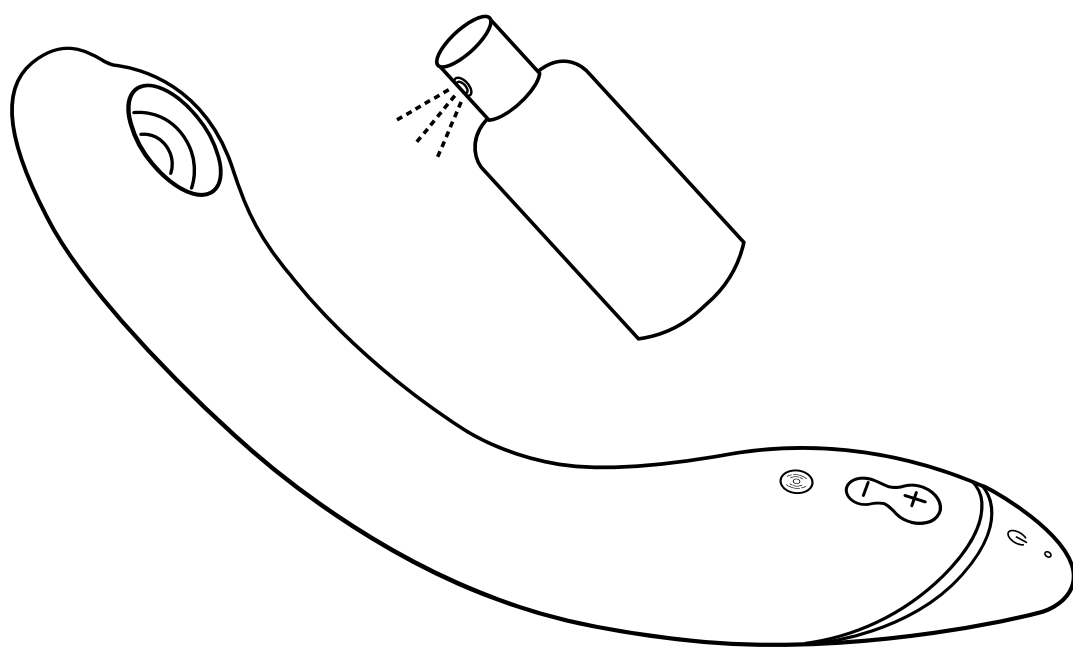

Сушете внимателно, без да прилагате твърде много натиск към мембраната.

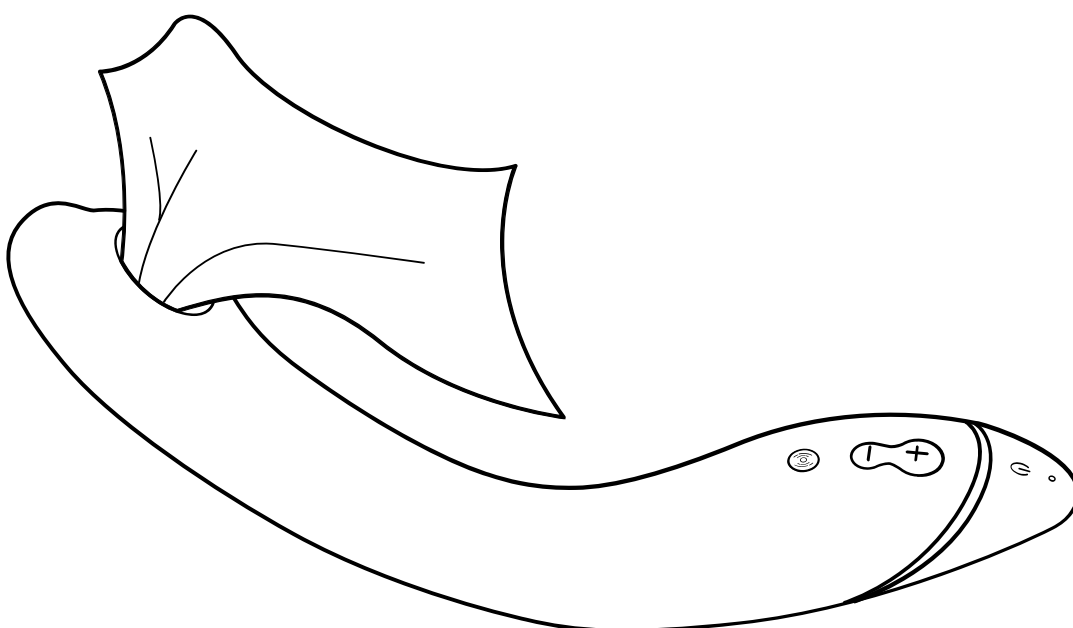

Водоустойчиво (IPX7)



# ЗАРЕЖДАНЕ

Заредете **OG** преди първата употреба. Също така не забравяйте да презареждате **OG** редовно, за да гарантирате дълъг живот на батерията.

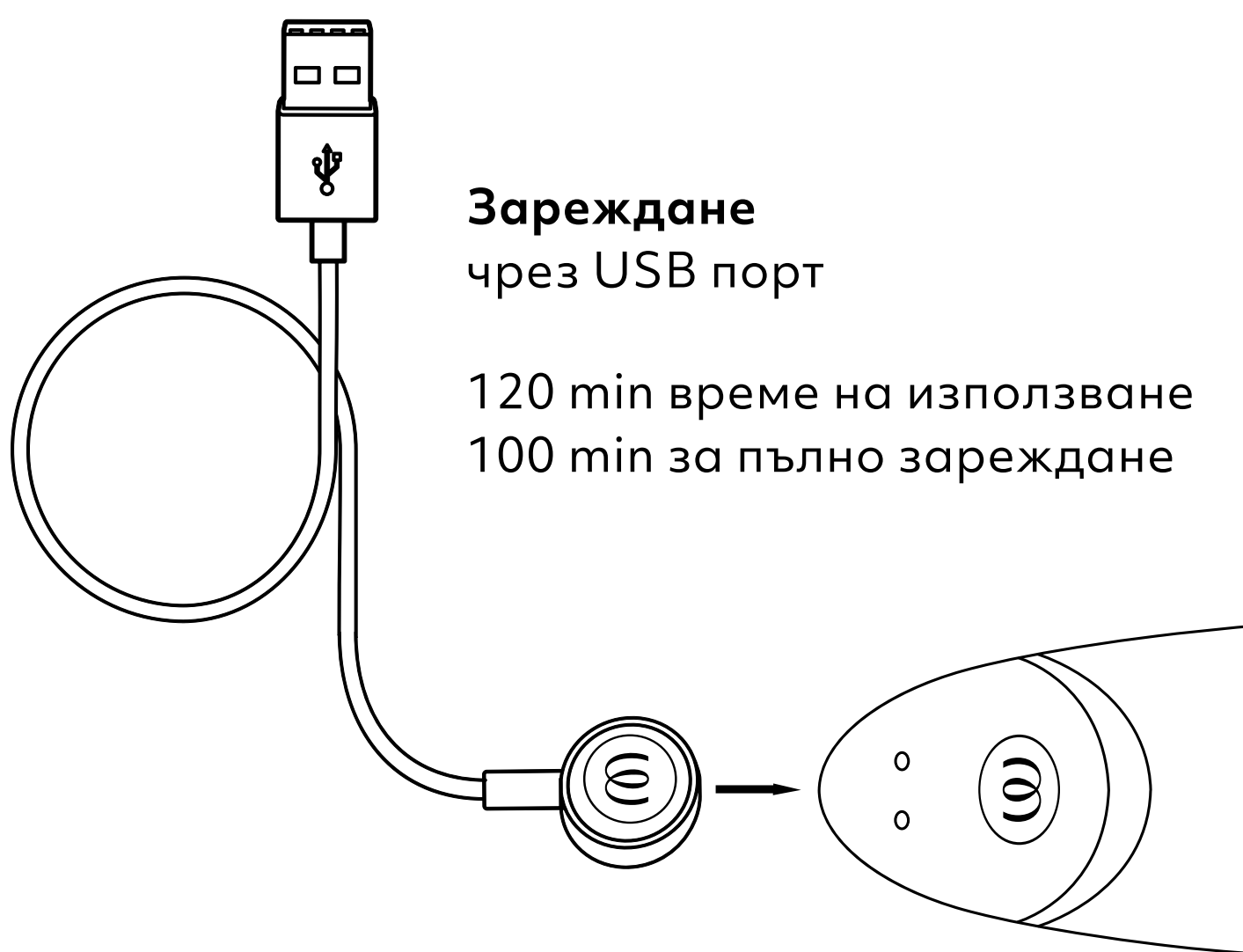

**Зареждане**  
чрез USB порт

120 min време на използване  
100 min за пълно зареждане

---

## Светодиод

Включено/Изключено/Зареждане

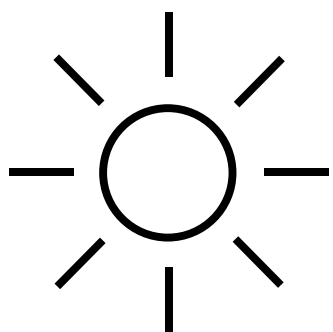

**Напълно заредено**  
Светодиодът свети  
непрекъснато

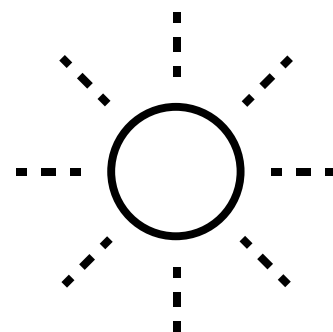

**Зареждане**  
Светодиодът мига

# ВНИМАНИЕ

## ПРЕДУПРЕЖДЕНИЕ

Продава се само като нов продукт. Продуктът следва да се използва само по предназначение. Дръжте продукта далеч от деца. Не е подходящ за медицински цели. Ако сте под грижите на лекар и/или имате заболяване, което изисква използването на някакво медицинско устройство, моля, консултирайте се с лекаря си преди да използвате този продукт. Прекратете незабавно използването на продукта, ако изпитате дразнене на кожата, болка или дискомфорт и се консултирайте с лекаря си.

Този уред може да бъде използван само от възрастни, както и от лица с намалени физически, сетивни или умствени способности или липса на опит и познания, ако са им били осигурени надзор или инструкции относно употребата на уреда по безопасен начин и те разбират свързаните с това опасности. Деца не следва да играят с уреда. Почистването и поддръжката от потребителя не следва да се извършват от деца. Да не се използва върху подути или възпалени области на кожата.

- Отстранете пиърсинга и бижутата в областта на гениталиите преди употреба.
- Винаги почиствайте продукта преди и след употреба съгласно инструкциите, дадени в това ръководство.
- За да се избегне повреждане на продукта, той и неговата батерия не трябва да се излагат на температури над 45°C, да се разглобяват и да се предпазват от механично и електронно повреждане.
- Съвместното използване на играчки може да доведе до предаване на болести по полов път. Не използвайте съвместно своите сексуални играчки с други потребители, освен партньора си. С партньора си използвайте защитни мерки, ако е необходимо. Не използвайте играчката, ако установите пропуквания или признаци на деградация на материала на покритието.
- Този продукт не е проектиран за анална употреба. Да не се използва анално!
- Не поставяйте меката страна на продукта си върху абсорбираща повърхност, за да се избегне появата на петна.
- Проверявайте зарядното устройство и продукта редовно за повреди и не използвайте устройството, ако някои от компонентите са повредени.
- Магнитните полета могат да повлияят на механични и електронни компоненти като пейсмейкъри. Не използвайте устройството директно над пейсмейкъра. За повече информация се свържете с Вашия лекар. Не носете карти с магнитни ленти (например кредитни карти) близо до устройството, тъй като те могат да бъдат повредени от магнитите на продукта.
- Ако играчката показва признаци, че не функционира правилно, изключете я и се консултирайте с раздела за поддръжка на нашия уебсайт.

## ЗАРЕЖДАНЕ

- Преди първата употреба на зарядното устройство, проверете напрежението на местната електрозахранваща мрежа, тъй като то не може да надвишава максималното входно напрежение от мрежата, посочено върху зарядното устройство.
- Към уреда трябва да се подава само безопасното много ниско напрежение, съответстващо на маркировката върху уреда.
- Не използвайте и не почиствайте продукта, докато батерията се зарежда.
- Никога не потапяйте зарядното устройство или кабела за зареждане във вода или други течности.
- Този уред съдържа батерии, които не се подменят.
- Този продукт съдържа акумулаторна литиево-йонна батерия.
- Изключвайте кабела за зареждане от веригата след всеки процес на зареждане.

## ЗА ОПТИМАЛНА УПОТРЕБА НА ПРОДУКТА, МОЛЯ, СЛЕДВАЙТЕ СЛЕДНИТЕ НАСОКИ:

- За да се гарантира дълъг експлоатационен живот на батерията, моля, зареждайте устройството редовно, дори и ако не се използва.
- Съхранявайте на сигурно, сухо място без излагане на пряка слънчева светлина.
- Препоръчваме да се използва лубрикантна водна основа с играчката. Не използвайте ароматизирани, лубриканти на силиконова или алкохолна основа, гелове или масажни масла, за да се избегне повреждане.

# GENERAL INFORMATION

## ELECTRICAL RATING

**Model:** OG

**Model No.:** TES10A

**Power Input:**

3,7 V=0,62 A: Built-in Li-Polymer rechargeable battery.

5 V=0,5 A: When charged using USB.

Use USB AC adaptor (not included) with power output corresponding to product rating. Use original provided cable only."

## CONTENT OF DELIVERY

Womanizer OG G-Spot vibrator, USB charging cable (AC adapter not included), cotton storage pouch, quick start guide, safety instructions

## ENVIRONMENTAL PROTECTION

As a distributor of electronic devices, we are legally obliged to accept the return of waste electrical and electronic devices free of charge. We expressly state that you as the user are legally obliged to return used batteries.

Never throw away electronic devices or batteries in the household waste. The symbol shown below (crossed-out wheeled bin) is intended to expressly remind you of this.

## MANUFACTURED AND DISTRIBUTED BY

**WOW Tech Europe GmbH**

Hermann-Blankenstein-Strasse 5

10249 Berlin

[www.wowtech.com](http://www.wowtech.com)

WOW Tech Europe GmbH reserves the right to make technical changes and changes to the design that serve to improve the device.

For information regarding patents see [womanizer.com/patents](http://womanizer.com/patents).

## CUSTOMER CARE

[care@womanizer.com](mailto:care@womanizer.com)

[womanizer.com](http://womanizer.com)

Designed in Germany. Made in China.

Date of issue: 10/2022.



# STILL WANT MORE?

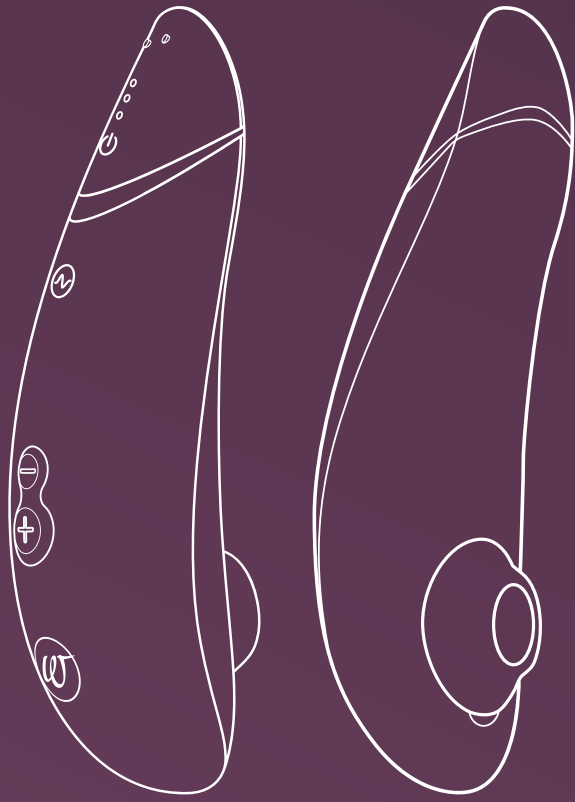

Pleasure Air  
Technology

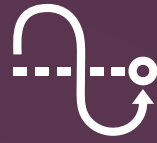

Autopilot



Smart Silence

**Premium 2**  
Define your luxury

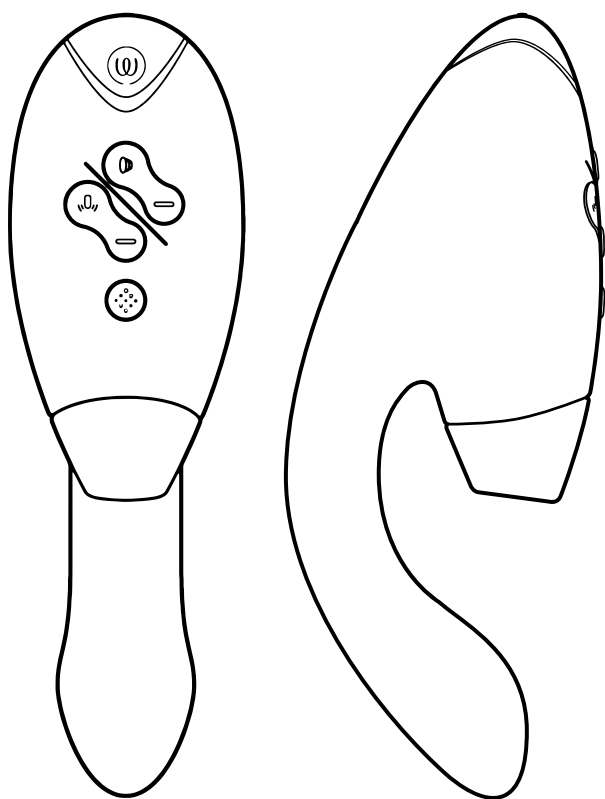

Pleasure Air  
Technology



Double Stimulation



Smart Silence

**Duo 2**  
Indulge in whole-body orgasms



#IMASTURBATE

# Hi!

Täname teid vibraatori **WOMANIZER OG** valimise eest.

Tere tulemast meeleliste elamuste maailma, mis rikastavad teie elu. Valides vibraatori **WOMANIZER**, pole teile tagatud mitte ainult võrreldamatud orgasmid, vaid ka täiesti uudne naudinguhimu.

Nautige oma vibraatorit **WOMANIZER OG** ja saage üks orgasm teise järel.

Armastage ennast!



KIRJELDUS

KASUTUSJUHEND

FUNKTSIOON SMART SILENCE

PUHASTAMINE

LAADIMINE

SAFETY INSTRUCTIONS

ÜLDTEAVE

Please read the safety instructions in the  
Compliance & Safety Information before first use.

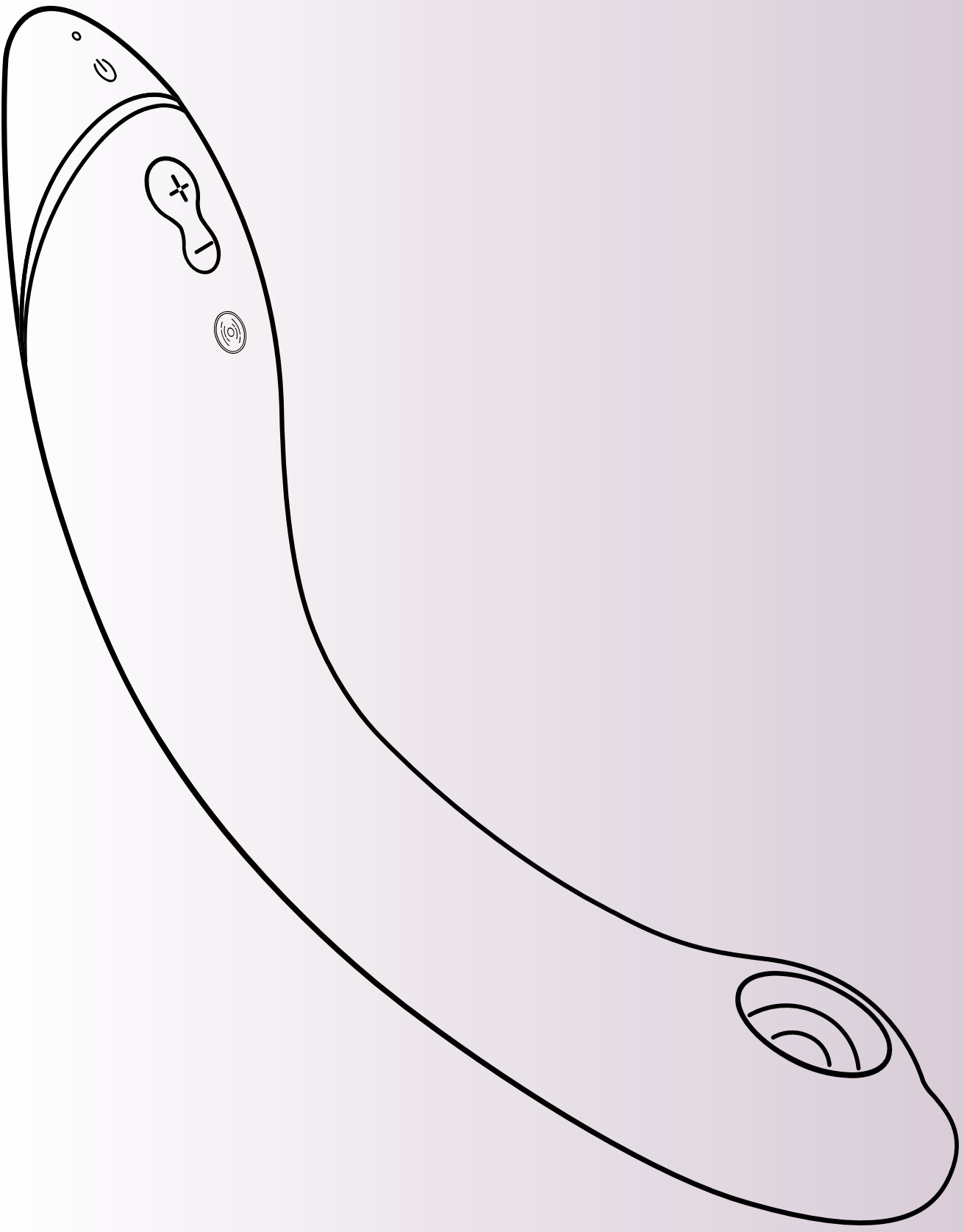



# KIRJELDUS

## LED-näidik

Sisselülitamine/laadimine

## Funktsiooni Smart Silence sisse-/ väljalülitamine

Hoidke all 2 sekundit

## Vibratsioon

Sisselülitamiseks  
ja intensiivsuse  
suurendamiseks  
vajutage korraks  
(3 astet)

## Pleasure Air Technology (12 astet)

## Sisse/välja

Hoidke all 2 sekundit

## Intensiivsuse suurendamine

Vajutage korraks nuppu (+)

## Intensiivsuse vähendamine

Vajutage korraks nuppu (-)

## Järelhelendumine

Hoidke nuppu (-) all 1 sekund

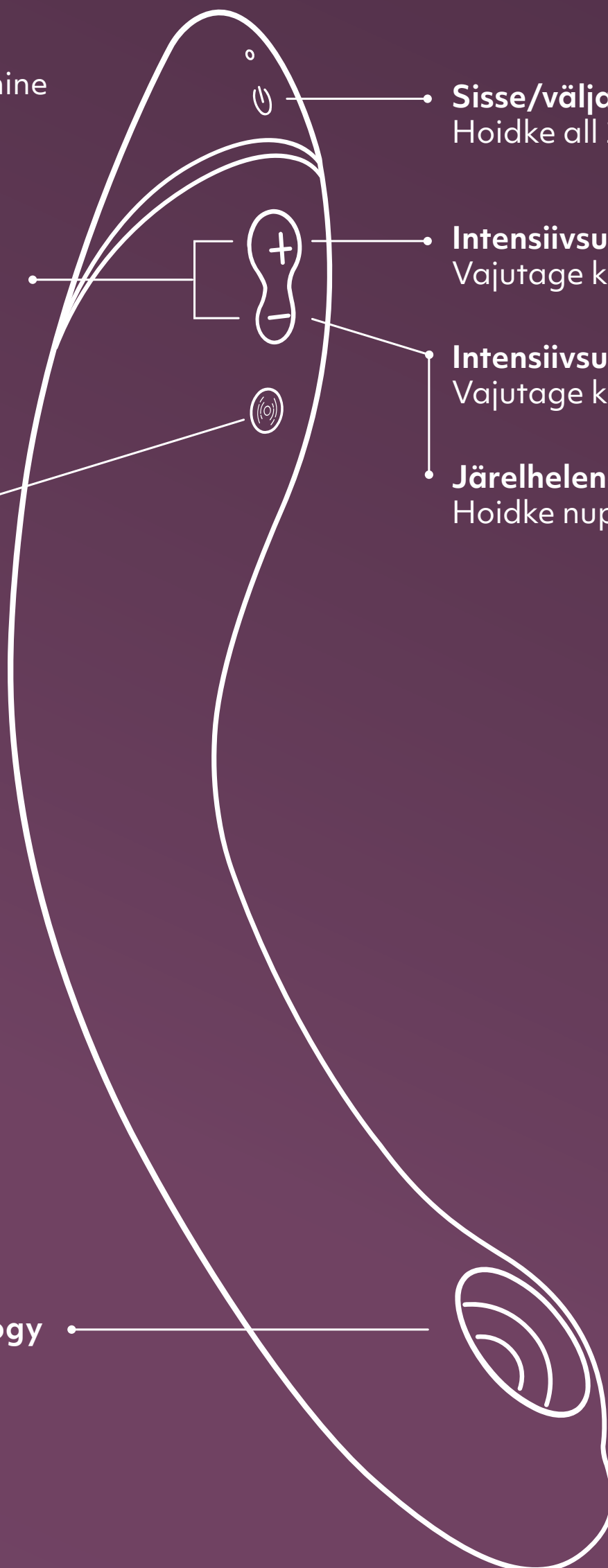

# KASUTUSJUHEND

## 1. Sisselülitamine

Hoidke all 2 sekundit. LED-märgutule süttimine näitab, et toode on sisse lülitatud.

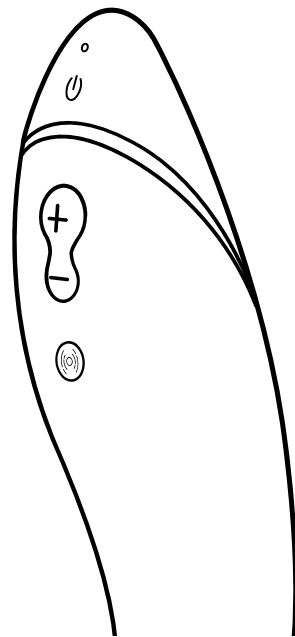

## 2. Kasutamine

Meeleolu loomiseks kasutage vibraatorit esmalt oma kliitoril.

Lisage vibraatori korpusele veepõhist määrdeainet.

Kui olete üles soojenenud, sisestage vibraator ja nautige oma G-punkti!

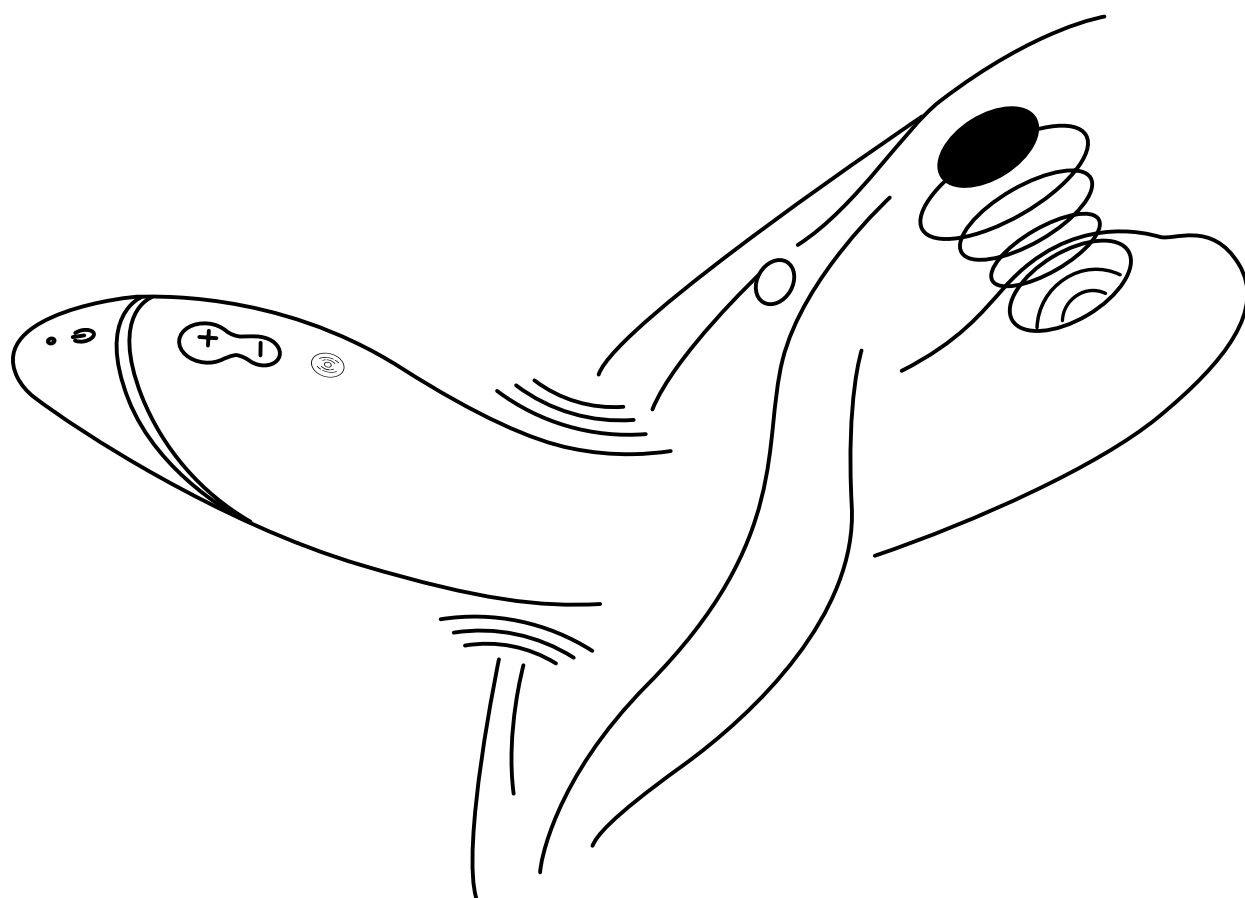
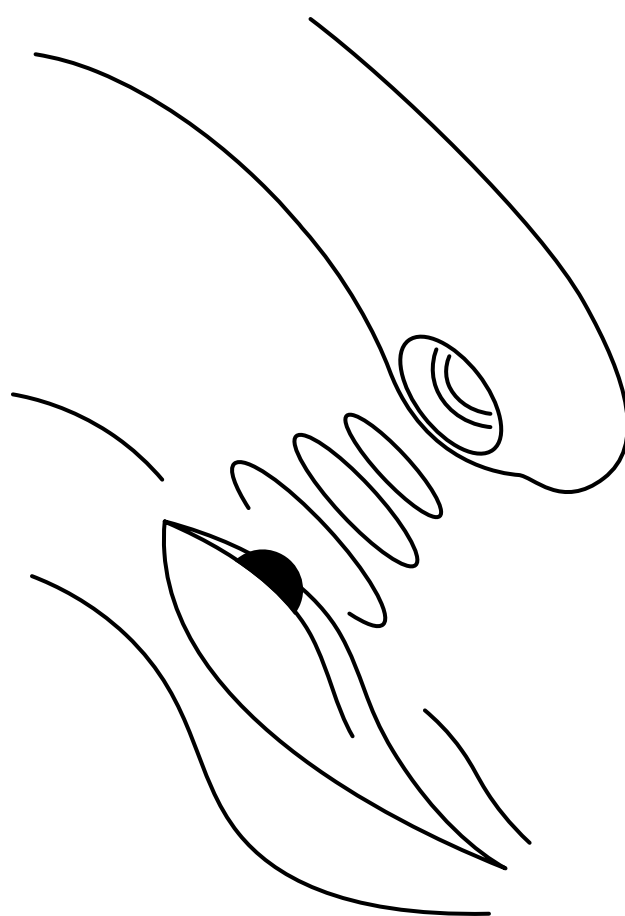

# KASUTUSJUHEND

## 3. Intensiivsuse muutmine

**Suurendamine** •  
Vajutage korraks  
**12 intensiivsustaset**

**Suurendamine** •  
Vajutage korraks  
**3 vibratsiooniastet**

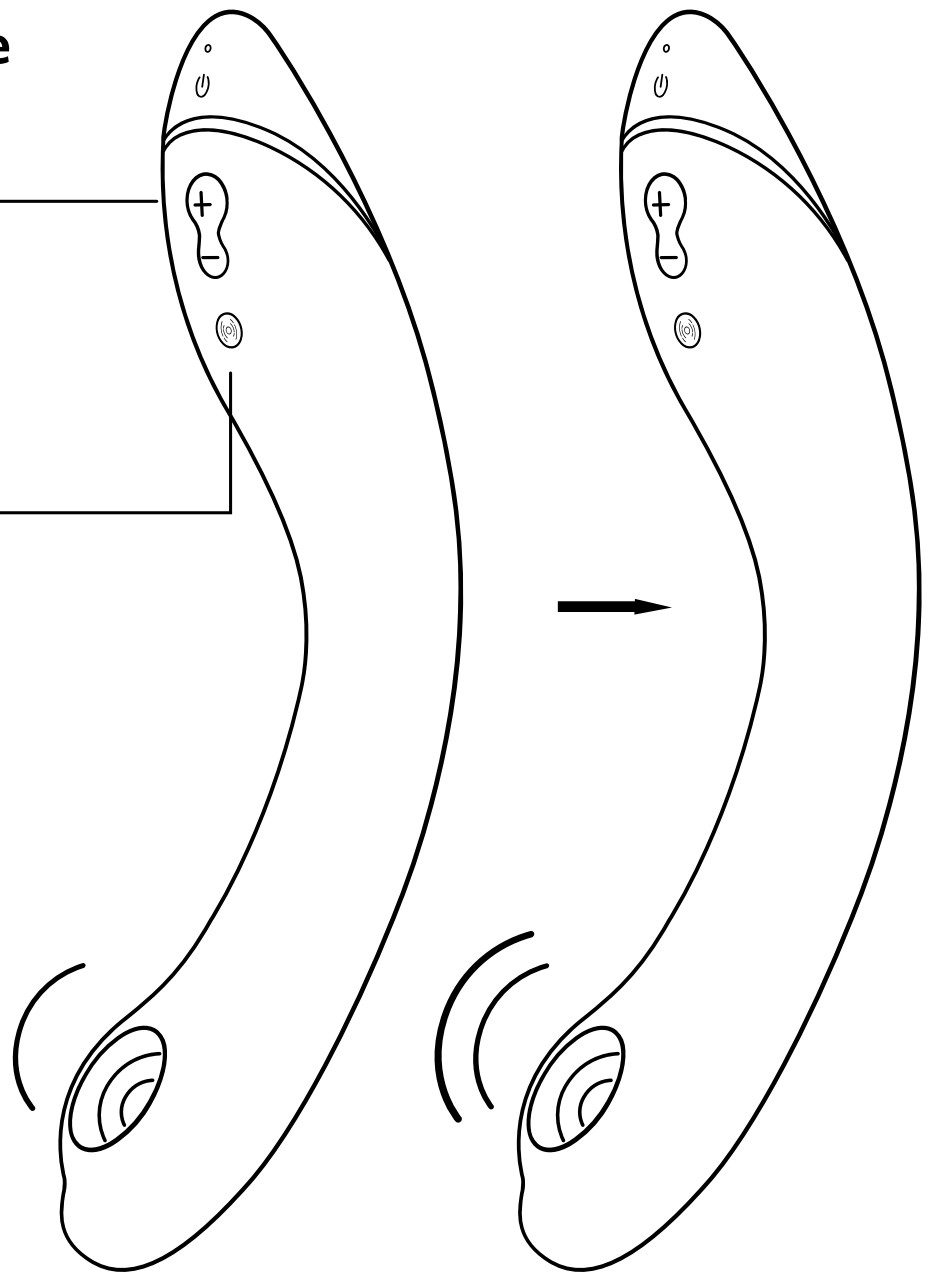

**Vähendamine** •  
Vajutage korraks

**Järelhelendumine**  
Intensiivsustasemele  
1 tagasilülitamiseks  
hoidke 1 sekund all  
nuppu (-).

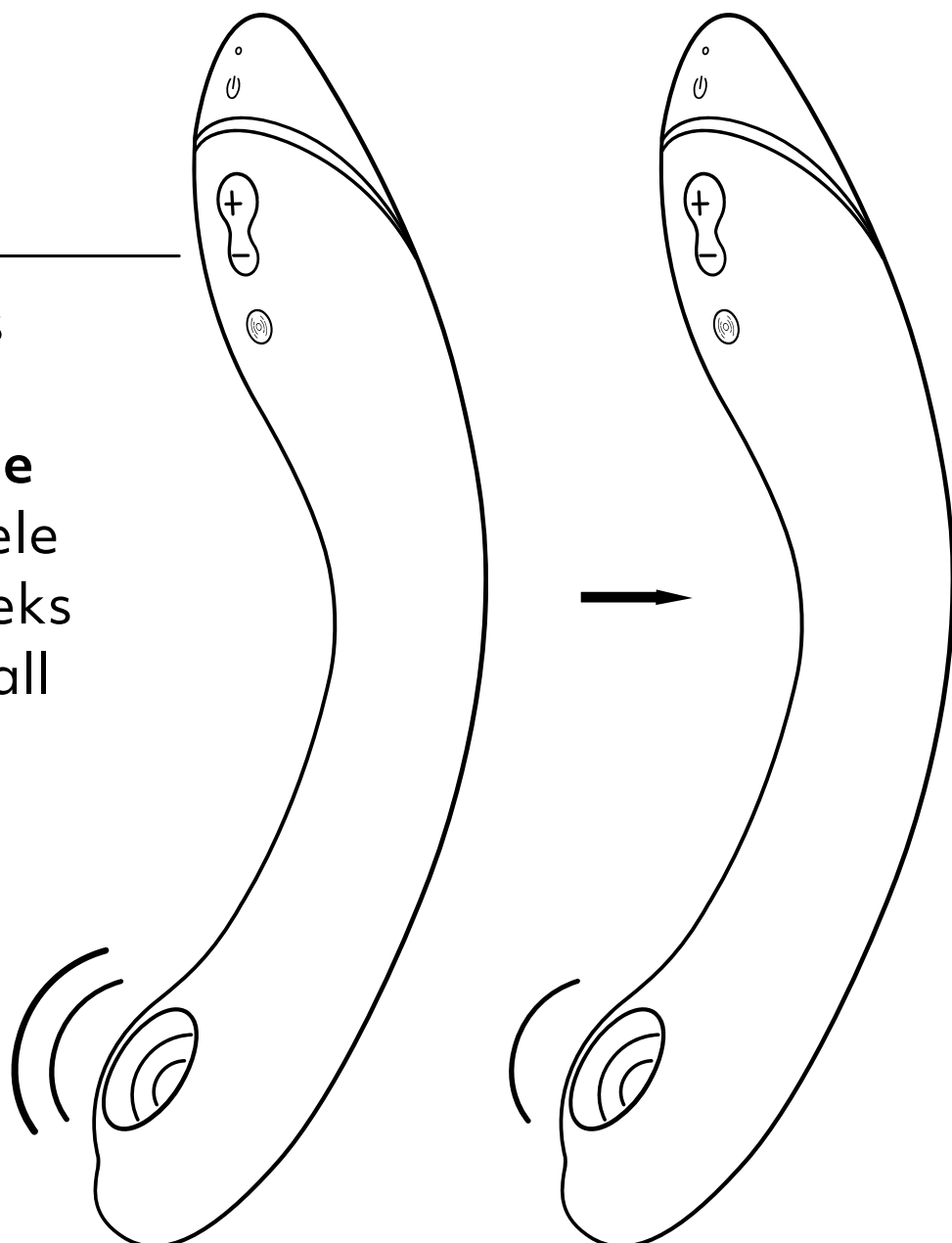

# KASUTUSJUHEND

## 4. Väljalülitamine

Hoidke all 2 sekundit

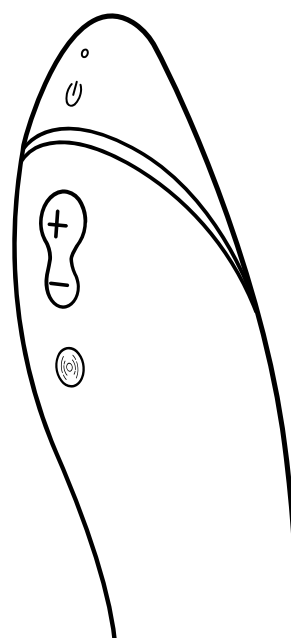

## FUNKTSIOON SMART SILENCE

Vibraator lülitub sisse alles siis, kui see on juba peaaegu nahka puudutamas. Funktsioon Smart Silence lülitub vaikimisi sisse. Funktsiooni Smart Silence sisse- või väljalülitamiseks hoidke pluss- ja miinusnupp all 2 sekundit.

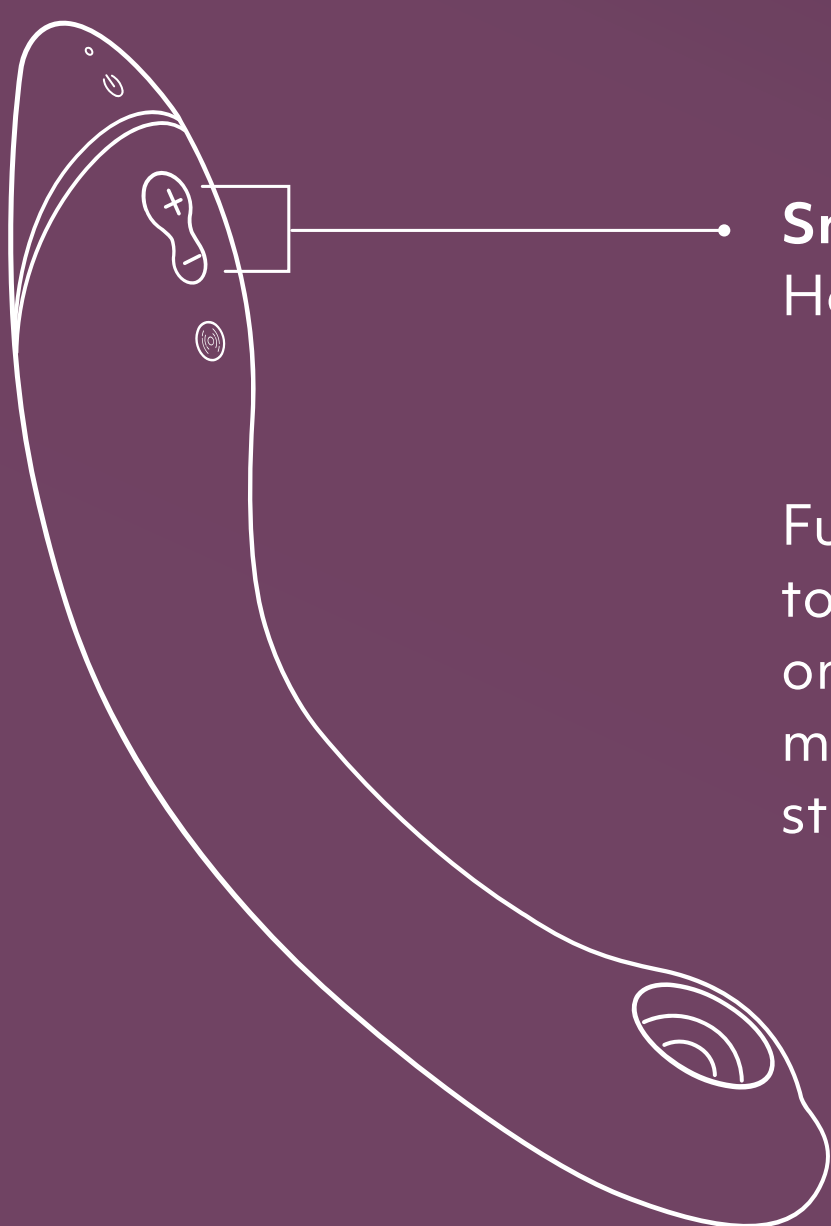

**Smart Silence Sisse/välja**  
Hoidke all 2 sekundit

Funktsioon Smart Silence ei pruugi toimida, kui stimulatsioonipea on märg. Seetõttu ärge kandke määrdeainet Pleasure Airi stimulatsioonipeale.

# PUHASTAMINE

Peske kooksva vee all.

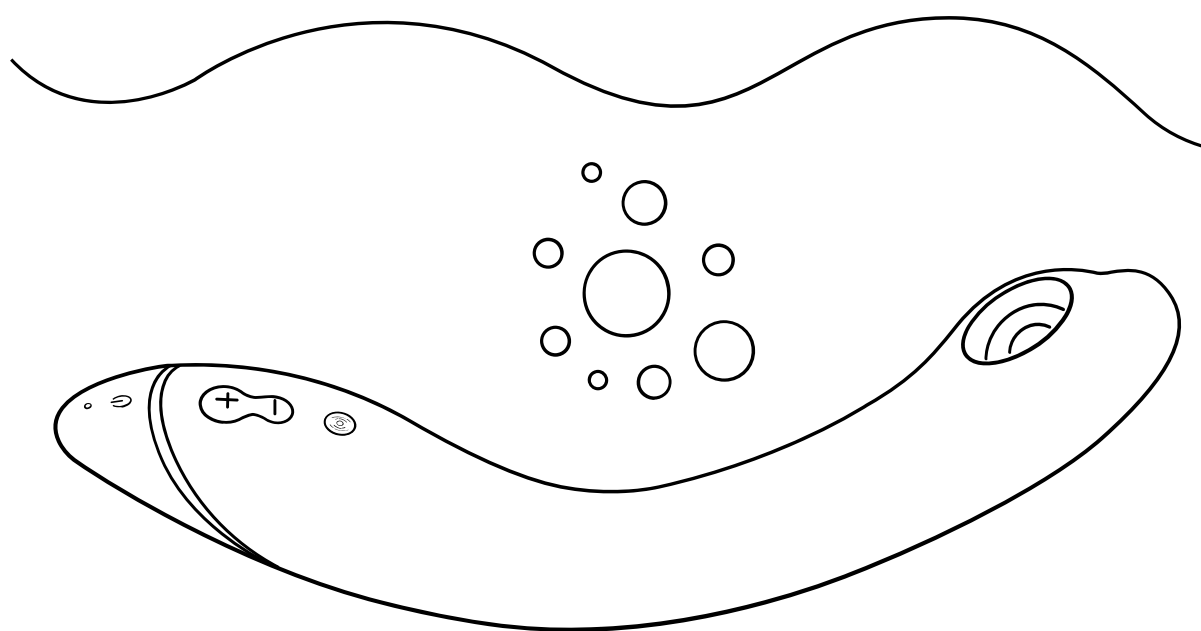

Kandke pinnale mänguasjade puhastusvahendit.

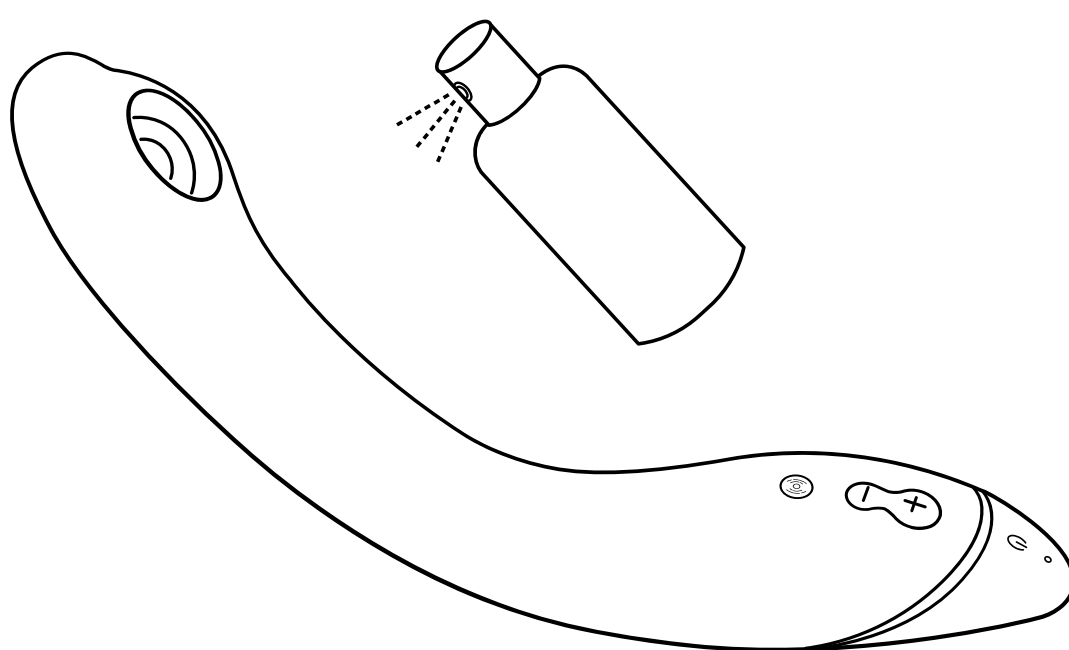

Kuivatage ettevaatlikult ilma membraanile liiga suurt survet rakendamata.

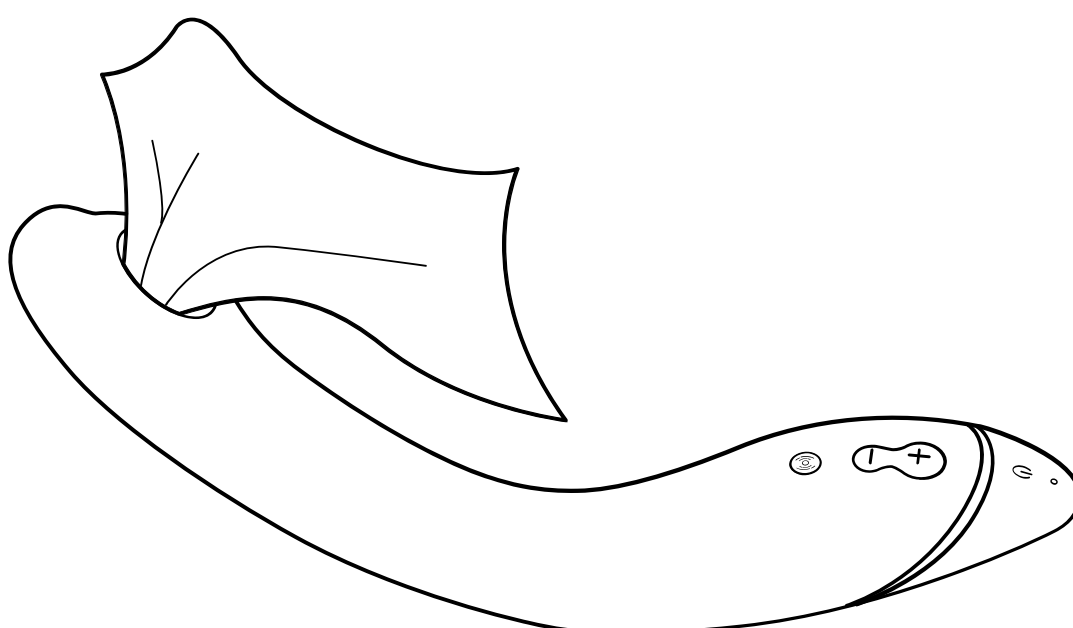

# LAADIMINE

Enne esmakordset kasutamist laadige vibraatorit. Ärge unustage vibraatorit regulaarselt laadida, et tagada aku pikk kasutusiga.

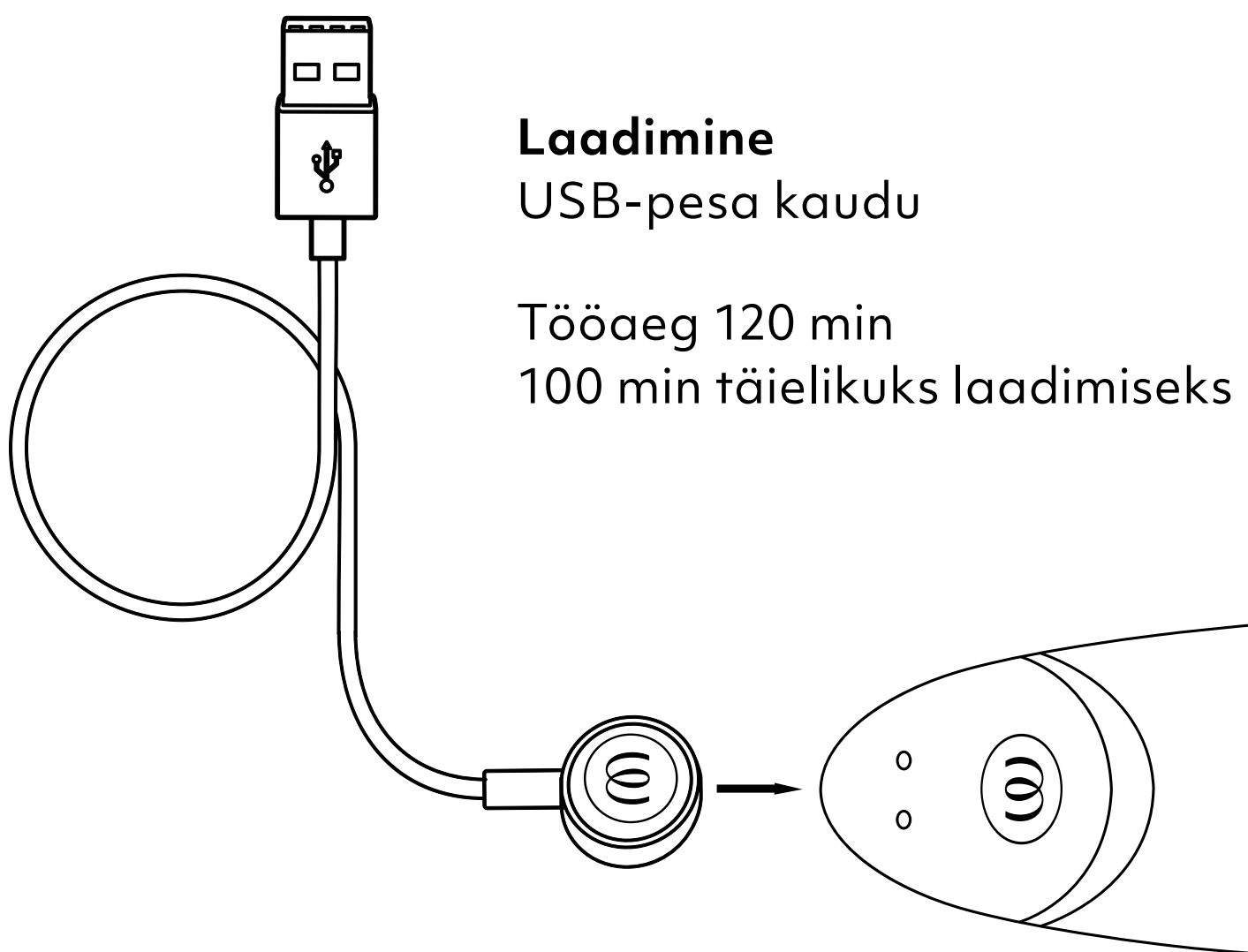

## Laadimine

USB-pesa kaudu

Tööaeg 120 min

100 min täielikuks laadimiseks

---

**LED-märgutuli**  
Sisse/välja/laadimine

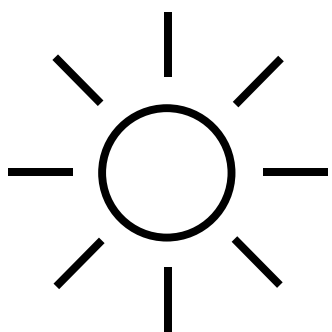

## Täielikult laetud

LED-märgutuli põleb pidevalt

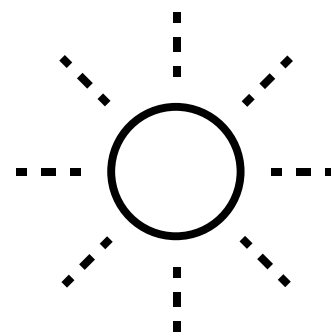

## Laadimine

LED-märgutuli vilgub

# SAFETY INSTRUCTIONS

## HOIATUS

Müüakse üksnes meelelahutuslikul eesmärgil. Kasuta toodet üksnes selleks ettenähtud otstarbel. Hoidke toodet lastele kättesaamatus kohas. Ei sobi meditsiiniliseks kasutuseks. Kui te saate ravi ja/ või teil on haigus, mis nõuab meditsiiniseadme kasutamist, siis pidage enne selle toote kasutamist nõu oma arstiga. Lõpetage kohe toote kasutamine, kui teil tekib nahaärritus, valu või ebamugavustunne, ja pidage nõu oma arstiga.

Seda toodet tohivad kasutada üksnes täiskasvanud ning piiratud füüsiliste, sensorsete või vaimsete võimetega isikud või kogemuste ja teadmisteta isikud juhul, kui nende tegevuse üle on järelvalve või neid on õpetatud toodet turvaliselt kasutama ning nad mõistavad toote kasutamisega kaasnevaid ohte. Lapsed ei tohi tootega mängida. Puhastamist ja kasutajahooldust ei tohi teha lapsed. Mitte kasutada paistes ega põletikulisel nahapiirkonnal.

- Enne kasutamist eemaldage needid ja ehted suguelundite piirkonnas.
- Puhastage toodet alati enne ja pärast kasutamist vastavalt kasutusjuhendis esitatud juhistele.
- Kahjustuste vältimiseks ei tohi toode ega aku viibida temperatuuril üle 45 °C, neid ei tohi lahti võtta ega mehaaniliselt ega elektriliselt kahjustada.
- Sekslelude jagamine teistega võib edasi kanda suguhaigusi. Ärge jagage oma sekslelusi kellegi teisega peale oma partneri. Vajaduse korral kasutage partneriga kaitsevahendeid. Ärge kasutage toodet, mille kattematerjalil on märke pragunemisest või see on kahjustunud.
- Toode ei ole mõeldud anaalseksi jaoks. Mitte kasutada anaalselt!
- Plekkide vältimiseks ärge pange toote pehmet osa imavale pinnale.
- Kontrollige laadijat ja mänguasia regulaarselt kahjustuste suhtes ning ärge kasutage seadet, kui selle mõni komponent on kahjustatud.
- Magnetväljad võivad mõjutada mehaanilisi ja elektroonilisi komponente, näiteks südamestimulaatoreid. Ärge kasutage seadet otse südamestimulaatori kohal. Lisateabe saamiseks pöörduge oma arsti poole. Ärge tooge seadme läheduses magnetribadega kaarte (nt krediitkaarte), kuna toote magnetid võivad neid kahjustada.
- Kui teie mänguasi paistab töötavat ebatavaliselt, lülitage see välja ning tutvuge meie veebisaidi tugiteenuse jaotisega.

## LAADIMINE

- Enne laadija esmakordset kasutamist kontrollige kohalikku pinget, sest kohalik võrgupinge ei tohi ületada laadijal näidatud suurimat lubatud võrgupinget.
- Toodet tohib kasutada üksnes ohutult madala pingega, mis on märgitud tootele.
- Ärge kasutage ega puhastage toodet aku laadimise ajal.
- Laadijat ega laadimisjuhet ei tohi kunagi panna vette ega muudesse vedelikesse.
- See toode sisaldab akusid, mida ei saa asendada.
- See toode sisaldab laetavat liitiumioonakut.
- Pärast iga laadimisprotsessi lahutage laadimiskaabel vooluringist.

## TOOTE OPTIMAALSEKS KASUTAMISEKS JÄRGIGE JÄRGMISI JUHISEID.

- Aku pika tööea tagamiseks laadige seadet regulaarselt, isegi kui see ei ole kasutusel.
- Hoiustage turvalises ja kuivas kohas ning eemal otsesest päikesevalgusest.
- Soovitame koos mänguasjaga kasutada vee baasil libestit. Kahjustuste vältimiseks ärge kasutage lõhnastatud, silikooni või alkoholi baasil libesteid, geele ega massaažiõlisid.

# GENERAL INFORMATION

## ELECTRICAL RATING

**Model:** OG

**Model No.:** TES10A

**Power Input:**

3,7 V=0,62 A: Built-in Li-Polymer rechargeable battery.

5 V=0,5 A: When charged using USB.

Use USB AC adaptor (not included) with power output corresponding to product rating. Use original provided cable only."

## CONTENT OF DELIVERY

Womanizer OG G-Spot vibrator, USB charging cable (AC adapter not included), cotton storage pouch, quick start guide, safety instructions

## ENVIRONMENTAL PROTECTION

As a distributor of electronic devices, we are legally obliged to accept the return of waste electrical and electronic devices free of charge. We expressly state that you as the user are legally obliged to return used batteries.

Never throw away electronic devices or batteries in the household waste. The symbol shown below (crossed-out wheeled bin) is intended to expressly remind you of this.

## MANUFACTURED AND DISTRIBUTED BY

**WOW Tech Europe GmbH**

Hermann-Blankenstein-Strasse 5

10249 Berlin

[www.wowtech.com](http://www.wowtech.com)

WOW Tech Europe GmbH reserves the right to make technical changes and changes to the design that serve to improve the device.

For information regarding patents see [womanizer.com/patents](http://womanizer.com/patents).

## CUSTOMER CARE

[care@womanizer.com](mailto:care@womanizer.com)

[womanizer.com](http://womanizer.com)

Designed in Germany. Made in China.

Date of issue: 10/2022.





# STILL WANT MORE?

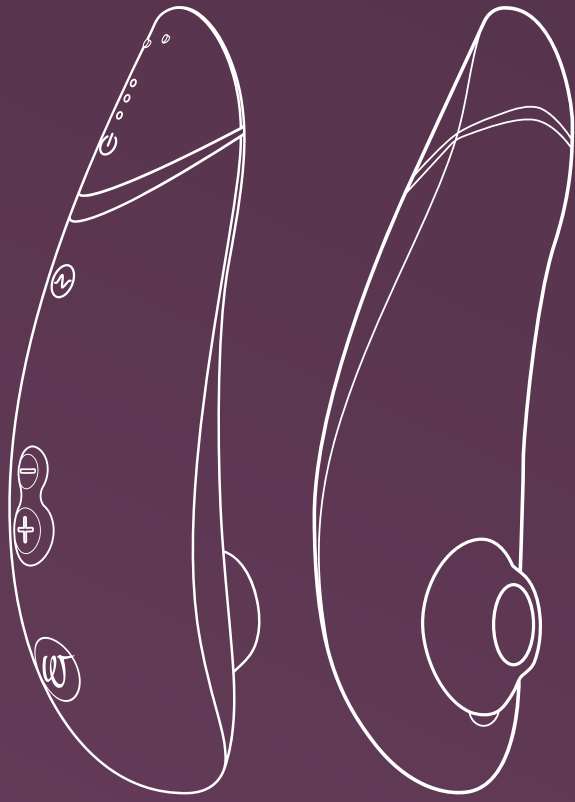

Pleasure Air  
Technology

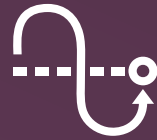

Autopilot



Smart Silence

**Premium 2**  
Define your luxury

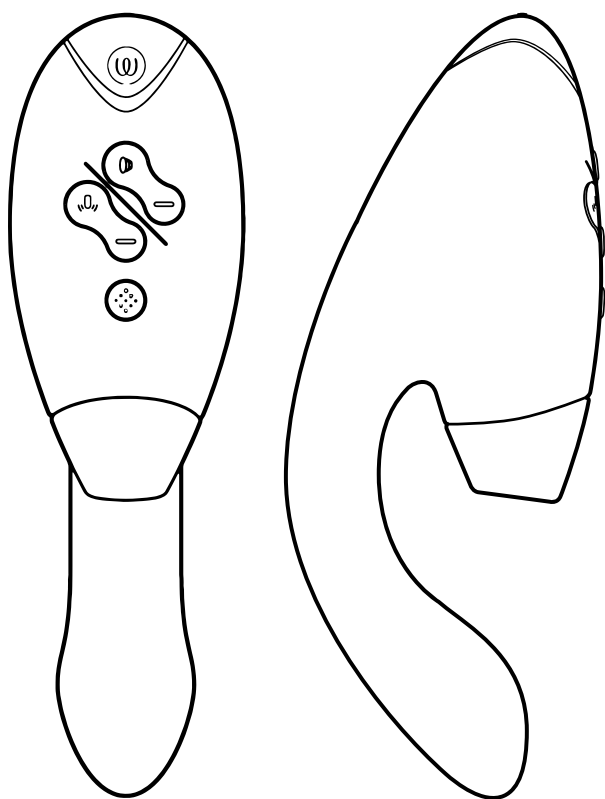

Pleasure Air  
Technology



Double Stimulation



Smart Silence

**DUO 2**  
Indulge in whole-body orgasms



#IMASTURBATE

# Hi!

Kiitos, että valitsit **WOMANIZERIN!**

Tervetuloa maailmaan täynnä elämäsi rikastavia aistikokemuksia. Kun valitset **WOMANIZERIN**, saat taatusti ylivoimaisia orgasmeja ja samalla opit himoitsemaan aivan uudenlaista mielihyvää.

Nauti **WOMANIZERISTASI** – orgasmi toisensa jälkeen.

Mene ja rakasta itseäsi!



KUVAUS

KÄYTTÖOHJE

ÄLYKÄS VAIMENNUS

PUHDISTAMINEN

LATAAMINEN

SAFETY INSTRUCTIONS

YLEISIÄ TIETOJA

Please read the safety instructions in the  
Compliance & Safety Information before first use.

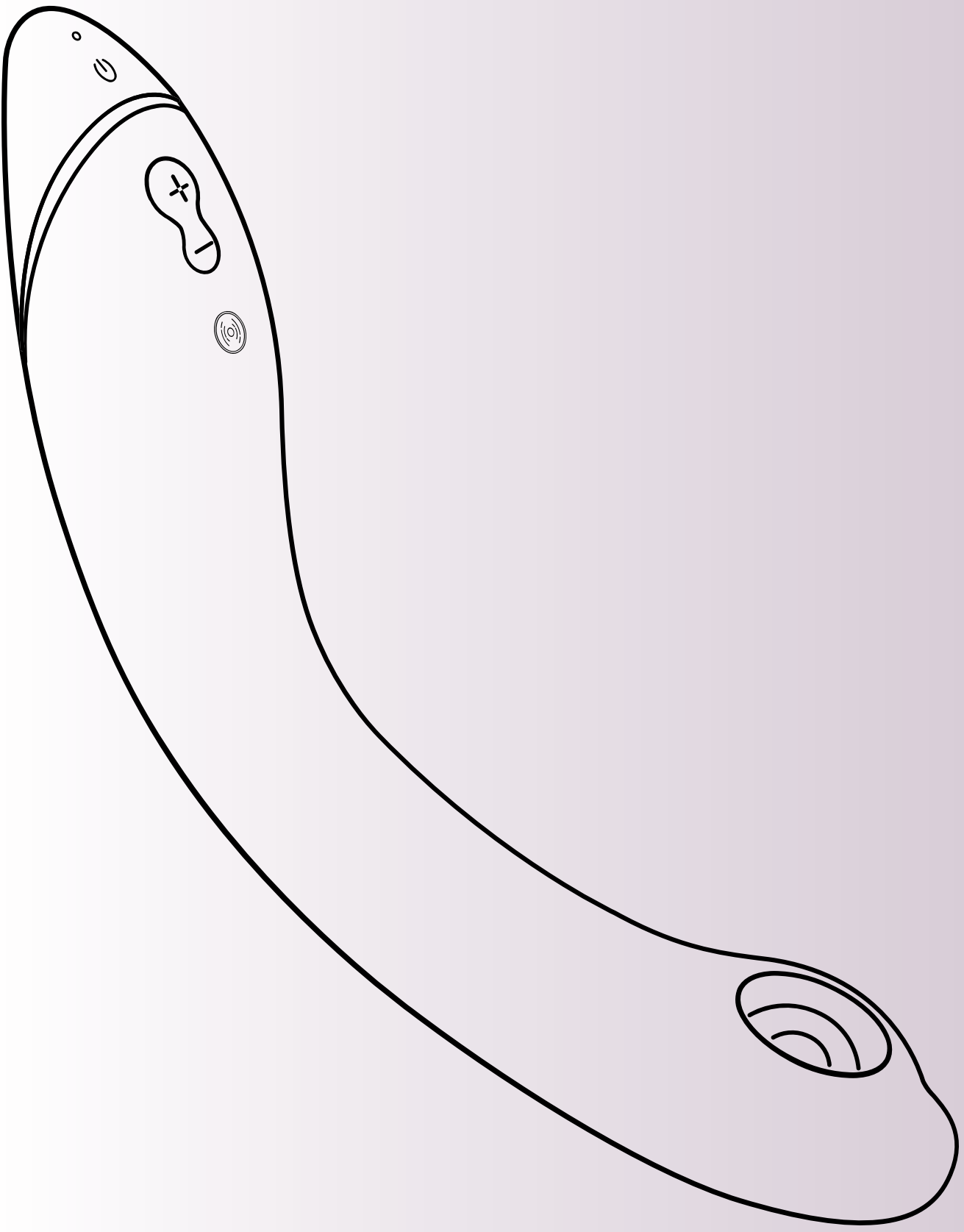

# KUVAUS

**LED-näyttö**  
Päällä/lataa

**Älykäs vaimennus**  
päälle / pois päältä  
Paina 2 sekuntia

**Värinä**  
Aktivoi ja lisää  
tehoa painamalla  
lyhyesti  
(12 tasoa)

**Pleasure Air Technology**  
12 tehotasoa

**Päälle / pois päältä**  
Paina 2 sekuntia

**Paina 2 sekuntia**  
Paina lyhyesti  
(+)-painiketta

**Vähennä tehoa**  
Paina lyhyesti  
(-)-painiketta

**Jälkiloisto**  
Paina (-)-painiketta 1  
sekunnin ajan



# KÄYTTÖOHJE

## 1. Kytke päälle

Paina 2 sekuntia  
LED ilmoittaa, että  
tuote on kytketty päälle.

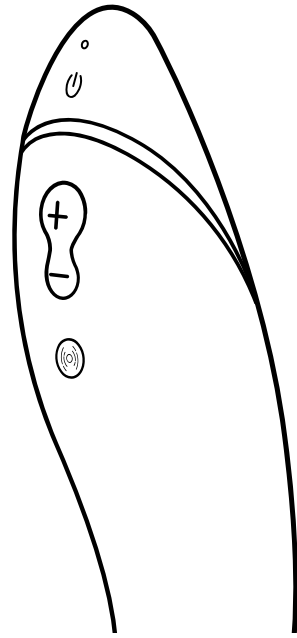

## 2. Käyttö

Tuo itsesi oikeaan  
mielialaan käyttämällä  
**OG**:tä ensin klitorikseesi.

Tuo itsesi oikeaan mielialaan  
käyttämällä **OG**:tä ensin  
klitorikseesi.

Kun olet lämmennyt, aseta **OG**  
sisään ja tutki G-pistettäsi!

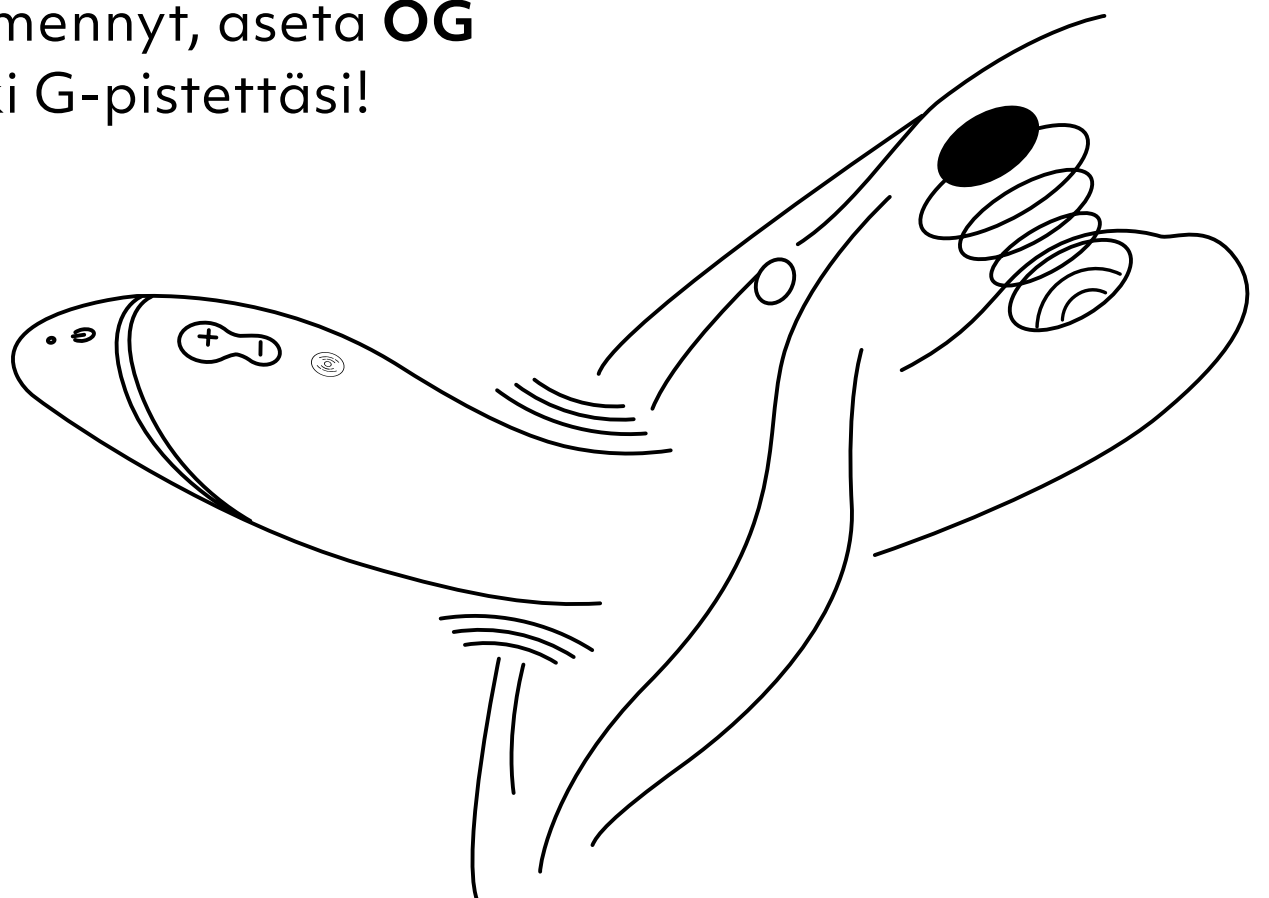
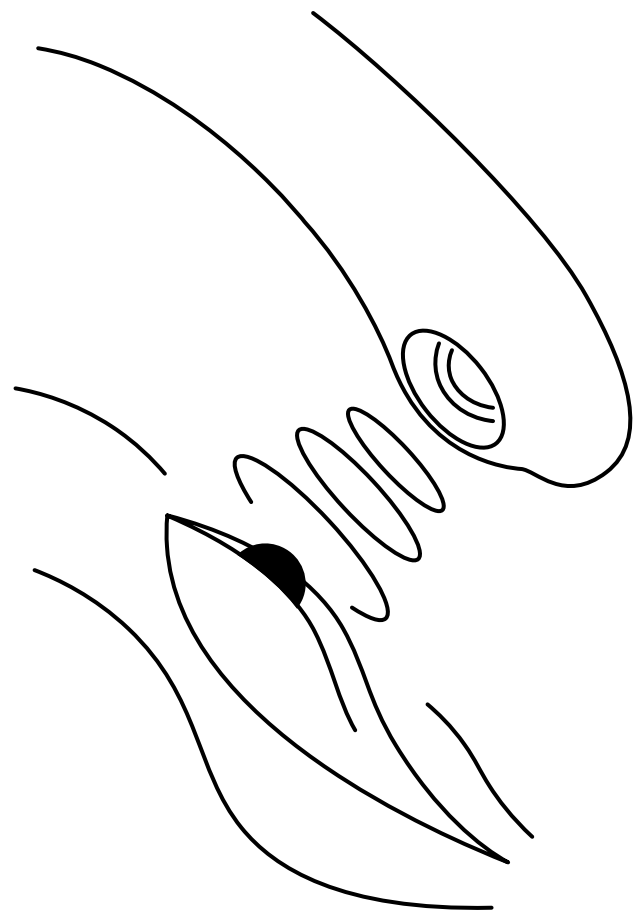

# KÄYTTÖOHJE

## 3. Muuta tehoa

**Lisää** •  
Paina lyhyesti  
**12 tehotasoa**

**Lisää** •  
Paina lyhyesti  
**3 värinätasoa**

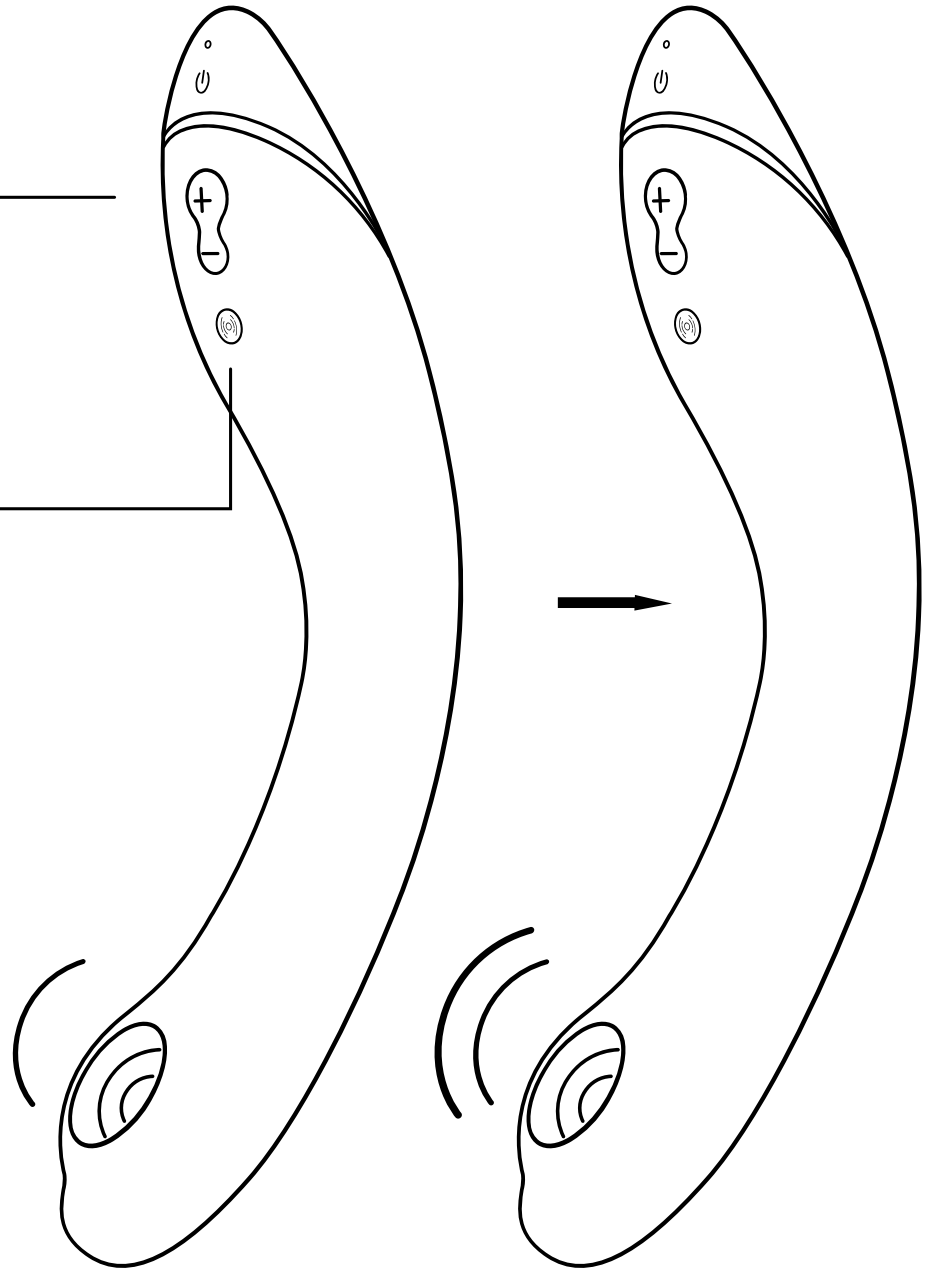

**Vähennä** •  
Paina lyhyesti

**Jälkiloisto**  
Kun (-)-painiketta  
painetaan 1 sekunnin  
ajan, tehotasoksi  
palaa taso 1

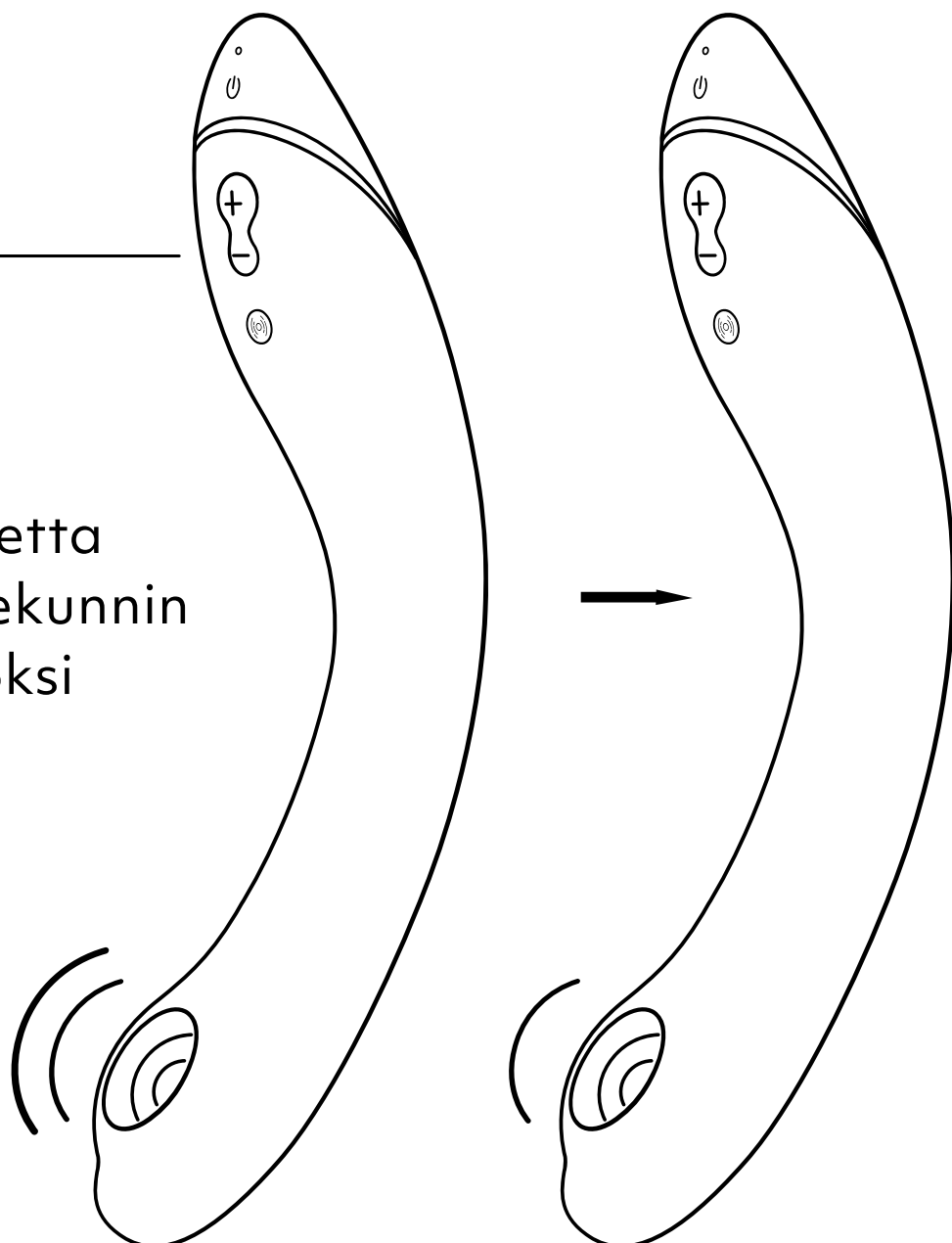



# KÄYTTÖOHJE

## 4. Sammuta

Paina 2 sekuntia

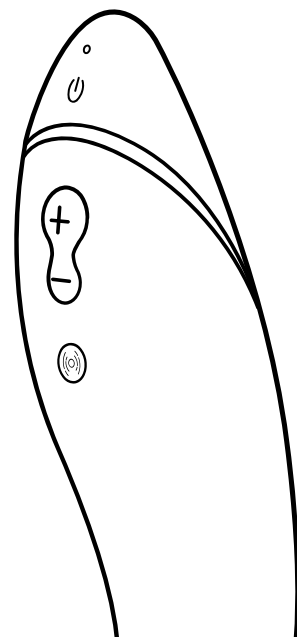

## ÄLYKÄS VAIMENNUS

**OG** kytkeytyy päälle vain, kun se lähes koskettaa ihoasi. Älykäs vaimennus kytkeytyy oletusarvoisesti päälle. Voit kytkeä älykkään vaimennuksen päälle tai pois päältä painamalla plus- ja miinuspainikkeita 2 sekunnin ajan.



**Smart Silence**  
**Päälle / pois päältä**  
Paina 2 sekuntia

Älykäs vaimennus ei välttämättä toimi, kun stimulointipää on märkä. Varmista siksi, ettet levitä liukastetta mielihyvöosan ilmapäähän.

# PUHDISTAMINEN

Pese veden alla.

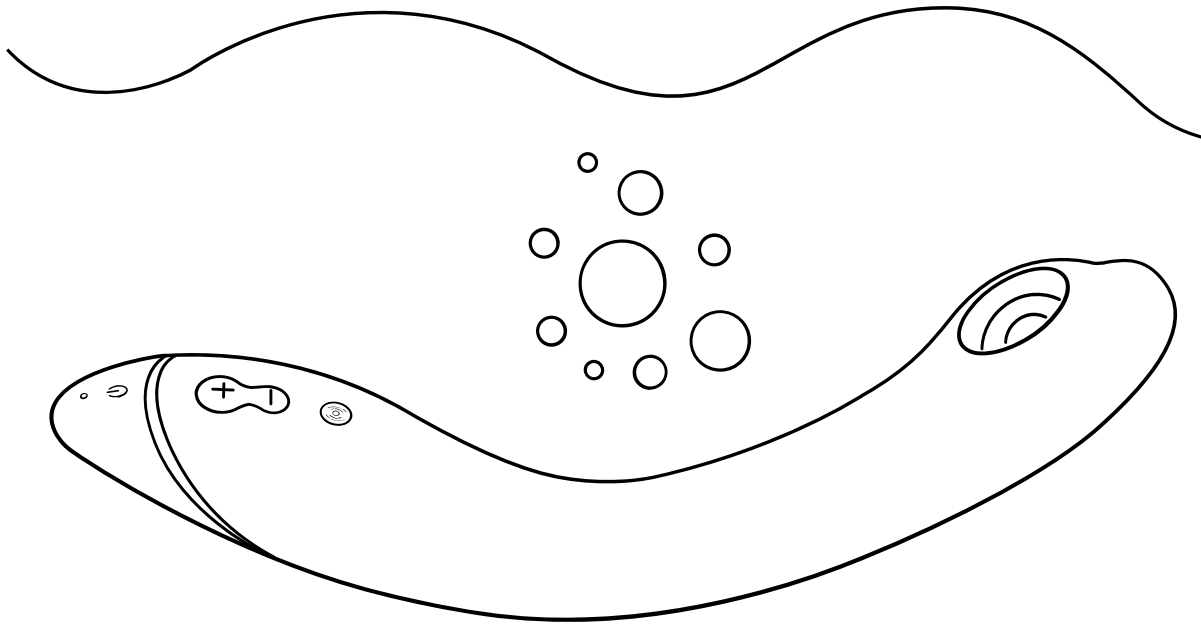

Käytä lelujen puhdistusainetta.

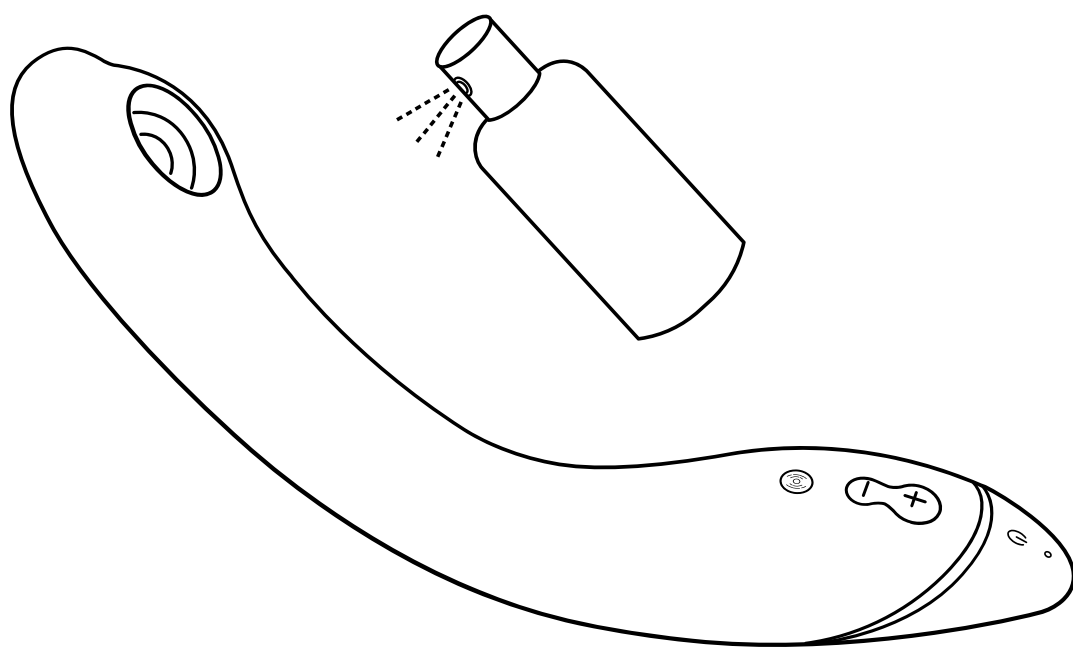

Kuivaa huolellisesti kohdistamatta liian kovaa painetta kalvoon.

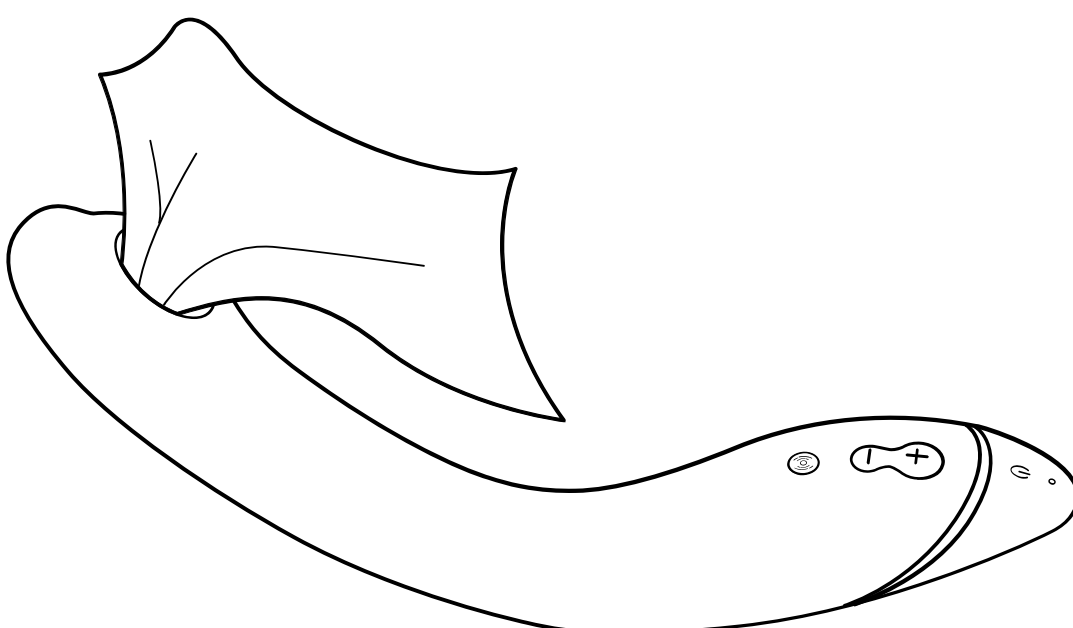

Vesitiivis (IPX7)

# LATAAMINEN

Lataa **OG** ennen ensimmäistä käyttökertaa.  
Muista myös ladata **OG** säännöllisesti,  
jotta sen akku kestää mahdollisimman pitkään.

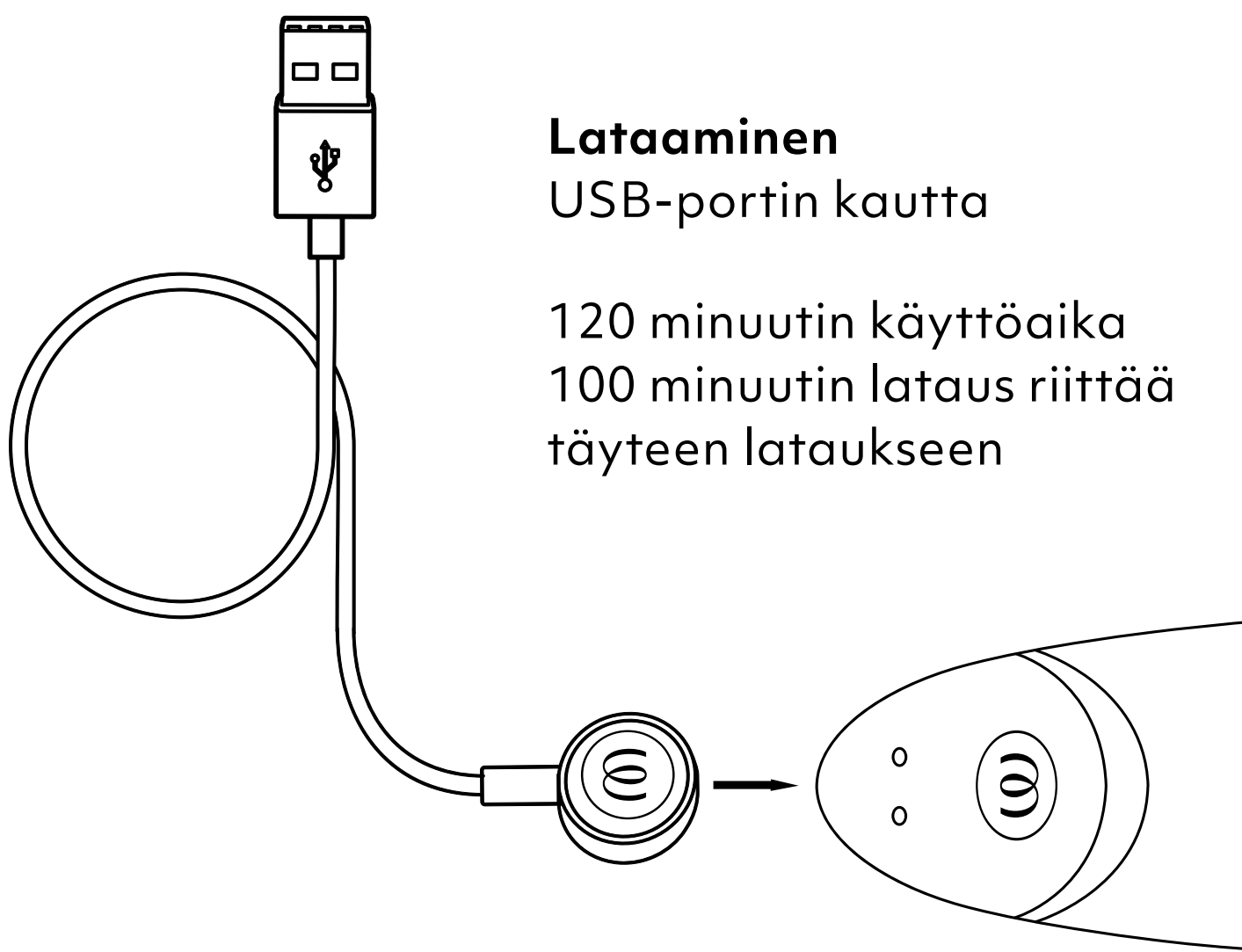

## Lataaminen

USB-portin kautta

120 minuutin käyttöaika  
100 minuutin lataus riittää  
täyteen lataukseen

---

## LED

Päällä / pois päältä / lataa

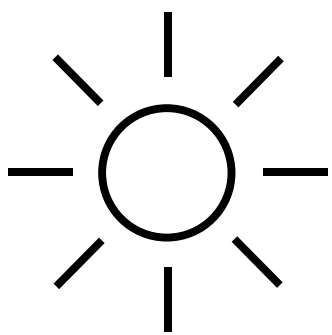

**Täyteen ladattu**  
LED syttyy jatkuvasti

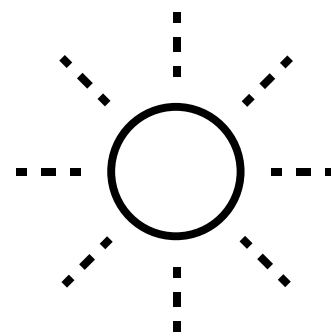

**Lataaminen**  
LED vilkkuu

# SAFETY INSTRUCTIONS

## VAROITUS

Myydään vain uutena tuotteena. Laitetta saa käyttää ainoastaan sen käyttötarkoituksen mukaisesti. Pidä tuote lasten ulottumattomissa. Ei sovellu lääketieteellisiin käyttötarkoituksiin. Jos olet lääkärin hoidossa ja/tai tilasi edellyttää terveydenhuollon laitteen käyttämistä, ota yhteys lääkäriisi ennen tämän tuotteen käyttämistä. Lopeta tuotteen käyttö välittömästi, jos havaitset ihoärsytystä, kipua tai muita haittoja, ja ota yhteys lääkäriisi.

Tätä laitetta saavat käyttää vain aikuiset. Henkilöt, joiden fyysinen tai henkinen toimintakyky tai tuntoaisti on heikentynyt tai joilla ei ole kokemusta tai tietoa laitteen käyttämisestä, voivat käyttää laitetta, kunhan heidät perehdytetään laitteen turvalliseen käyttöön ja kunhan he ymmärtävät, mitä riskejä laitteen käyttöön liittyy. Lapset eivät saa leikkiä laitteella. Lapset eivät saa puhdistaa eivätkä huoltaa laitetta. Laitetta ei saa käyttää turvonneilla tai tulehtuneilla ihoalueilla.

- Poista lävistyksiset ja korut sukuelinten alueelta ennen käyttöä.
- Puhdista tuote aina ennen käyttöä ja sen jälkeen tässä käyttöohjeessa annettujen ohjeiden mukaisesti.
- Jotta vältetään tuotteen vaurioituminen, tuotetta ja sen akkua ei saa altistaa yli 45 °C:n lämpötilalle, eikä tuotetta saa purkaa tai vaurioittaa mekaanisesti tai sähköisesti.
- Seksilelujen yhteiskäytöstä voi saada sukupuolitauditartunnan. Älä käytä seksilelujasi muiden kuin oman kumppanisi kanssa. Jos tarpeen, käytä kumppanisi kanssa asianmukaisia suojia. Älä käytä lelua, jos huomaat siinä halkeamia tai merkkejä pintamateriaalin heikkenemisestä.
- Tätä tuotetta ei ole suunniteltu käytettäväksi peräaukossa. Älä käytä laitetta anaaliseksiissä!
- Älä aseta tuotteen pehmeää pintaa imukykyiselle pinnalle tahrojen välttämiseksi.
- Tarkista latauslaite ja tuote säännöllisesti vaurioiden varalta. Älä käytä tuotetta, jos jokin sen komponenteista on vaurioitunut.
- Magneettikentät voivat vaikuttaa mekaanisiin ja elektronisiin komponentteihin, kuten sydämentahdistimiin. Älä käytä laitetta suoraan sydämentahdistimen päällä. Ota yhteyttä lääkäriisi, jos haluat lisätietoja. Älä tuo kortteja, joissa on magneettiraitoja (esim. luottokortteja), laitteen lähelle, koska tuotteen magneetti voi vahingoittaa niitä.
- Jos tuote vaikuttaa toimivan epätavallisesti, kytke se pois päältä ja ota yhteys tukipalveluumme verkkosivustomme kautta.

## LATAAMINEN

- Ennen kuin käytät latauslaitetta ensimmäistä kertaa, tarkista paikallisen sähköverkon jännitetaso, sillä paikallisen sähköverkon pääjännite ei saa ylittää suurinta sallittua pääjännitettä, joka on merkitty latauslaitteeseen.
- Turvallisuuden takia laitteeseen saa syöttää vain erittäin pientä jännitettä, joka vastaa laitteessa olevaa merkintää.
- Älä käytä tai puhdista tuotetta, kun akkua ladataan.
- Älä upota latauslaitetta tai latausjohtoa veteen tai muihin nesteisiin.
- Tämä laite sisältää akun, jota ei voi vaihtaa.
- Tämä tuote sisältää ladattavan litiumioniakun.
- Irrota latauskaapeli virtapiiristä jokaisen latausprosessin jälkeen.

## TUOTTEEN OPTIMAALINEN KÄYTTÖ EDELLYTTÄÄ SEURAAVIEN OHJEIDEN NOUDATTAMISTA:

- Jotta akku kestäisi pitkään, lataa laitetta säännöllisesti, vaikka tuotetta ei käytettäisi.
- Säilytä tuote turvallisessa ja kuivassa paikassa suojassa suoralta auringonvalolta.
- Suosittelemme vesipohjaisen liukuvoiteen käyttämistä tuotteen yhteydessä. Älä käytä hajustettua, silikonipohjaista tai alkoholipohjaista liukuvoidetta, geeliä tai hierontaöljyä, jotta tuote ei vaurioidu.

# GENERAL INFORMATION

## ELECTRICAL RATING

**Model:** OG

**Model No.:** TES10A

**Power Input:**

3,7 V=0,62 A: Built-in Li-Polymer rechargeable battery.

5 V=0,5 A: When charged using USB.

Use USB AC adaptor (not included) with power output corresponding to product rating. Use original provided cable only."

## CONTENT OF DELIVERY

Womanizer OG G-Spot vibrator, USB charging cable (AC adapter not included), cotton storage pouch, quick start guide, safety instructions

## ENVIRONMENTAL PROTECTION

As a distributor of electronic devices, we are legally obliged to accept the return of waste electrical and electronic devices free of charge. We expressly state that you as the user are legally obliged to return used batteries.

Never throw away electronic devices or batteries in the household waste. The symbol shown below (crossed-out wheeled bin) is intended to expressly remind you of this.

## MANUFACTURED AND DISTRIBUTED BY

**WOW Tech Europe GmbH**

Hermann-Blankenstein-Strasse 5

10249 Berlin

[www.wowtech.com](http://www.wowtech.com)

WOW Tech Europe GmbH reserves the right to make technical changes and changes to the design that serve to improve the device.

For information regarding patents see [womanizer.com/patents](http://womanizer.com/patents).

## CUSTOMER CARE

[care@womanizer.com](mailto:care@womanizer.com)

[womanizer.com](http://womanizer.com)

Designed in Germany. Made in China.

Date of issue: 10/2022.



# STILL WANT MORE?

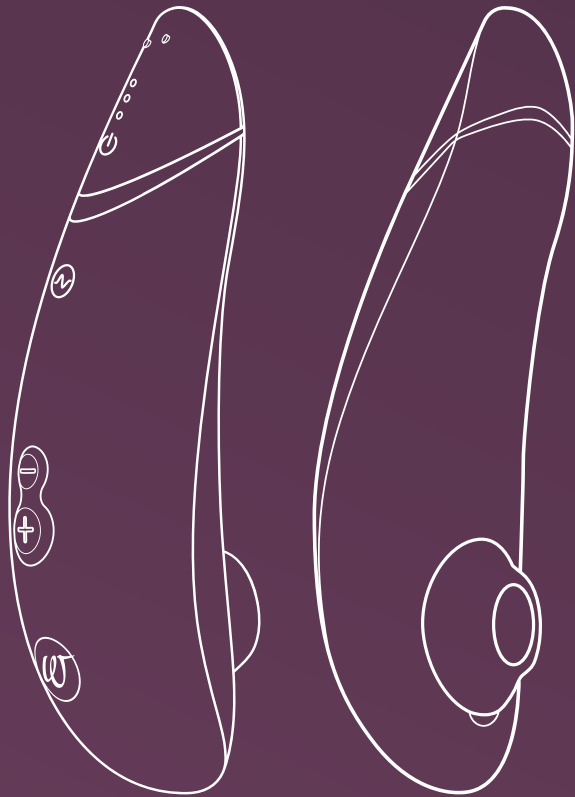

Pleasure Air  
Technology

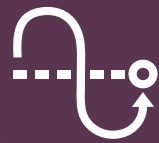

Autopilot



Smart Silence

**Premium 2**  
Define your luxury

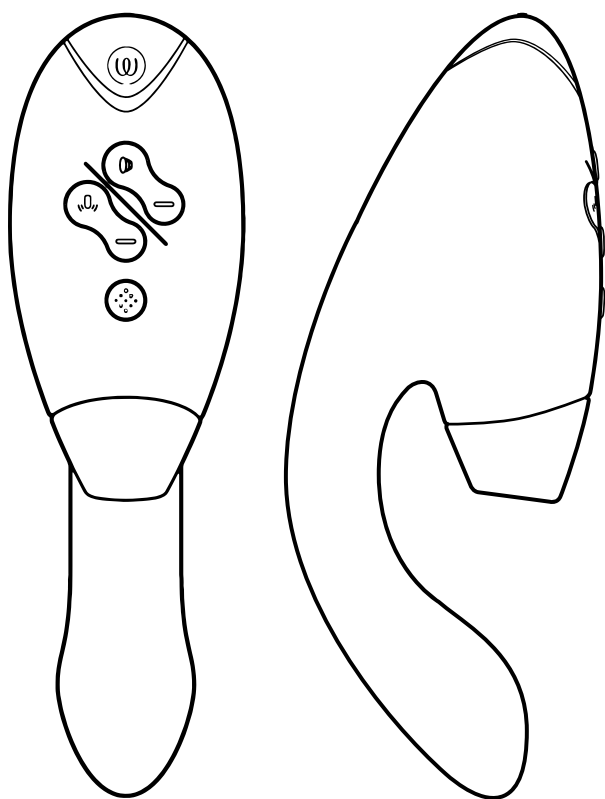

Pleasure Air  
Technology



Double Stimulation



Smart Silence

**DUO 2**  
Indulge in whole-body orgasms



#IMASTURBATE

# Hi!

Köszönjük, hogy a **WOMANIZERT** választottad!

Érzéki élményekkel teli útra léptél.

A **WOMANIZER** nem csak garantáltan a csúcsra juttat – és ilyen orgazmusokban még egészen biztosan nem volt részed –, de a legbujább kéjvágyat is felébreszti benned.

Élvezd a **WOMANIZER**

nyújtotta gyönyört – orgazmusról orgazmusra.

Szeresd magad!





LEÍRÁS

HASZNÁLATI ÚTMUTATÓ

SMART SILENCE

TISZTÍTÁS

TÖLTÉS

SAFETY INSTRUCTIONS

ÁLTALÁNOS INFORMÁCIÓK

Please read the safety instructions in the  
Compliance & Safety Information before first use.

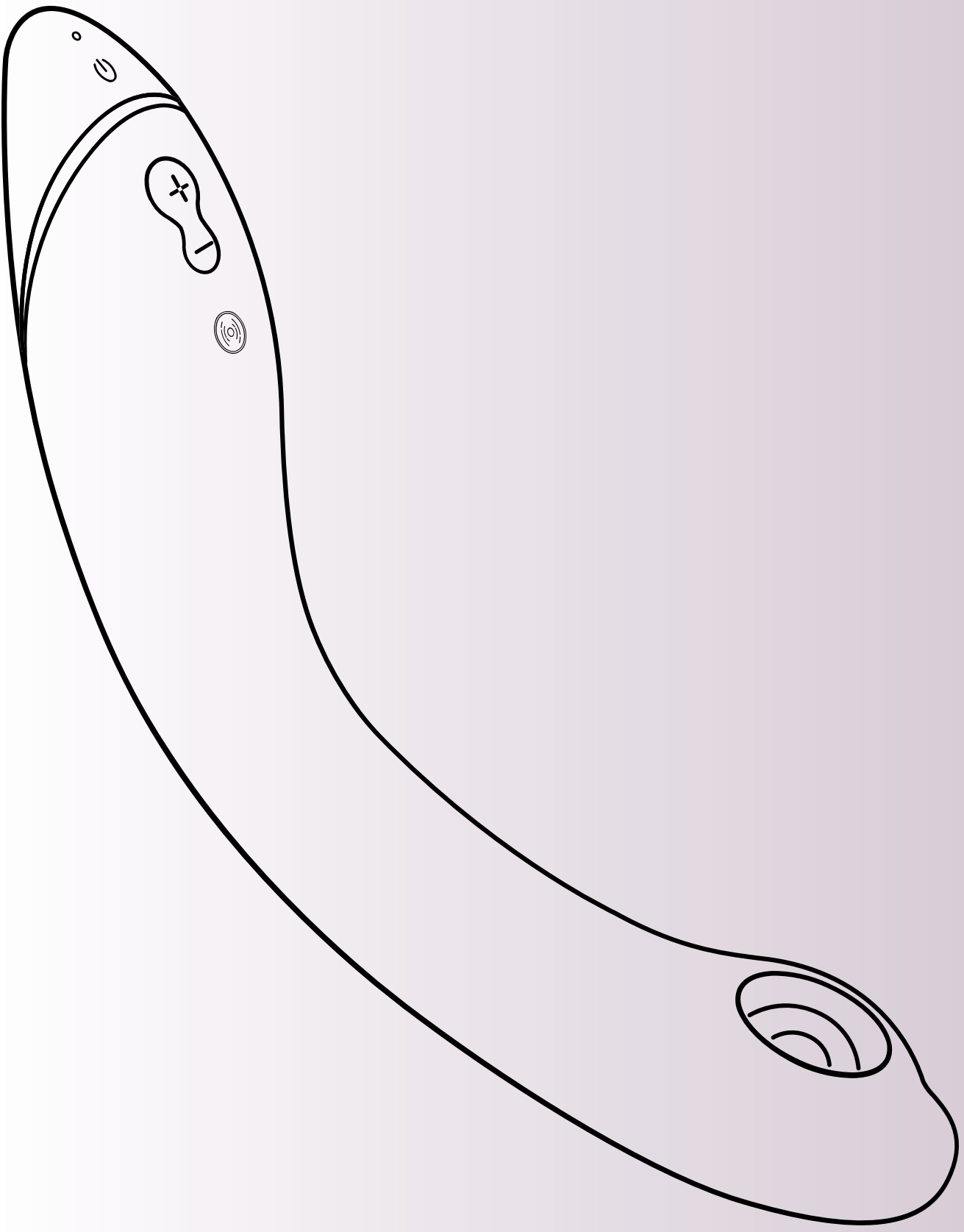

# LEÍRÁS

**LED-kijelző**  
Be/Töltés

**Smart Silence**  
**be/ki**  
Tartsd lenyomva  
2 másodpercig

**Vibráció**  
Nyomd meg  
röviden az  
aktiváláshoz  
és az intenzitás  
növeléséhez  
(3 szint)

**Pleasure Air Technology**  
(12 intenzitási szint)

**Be/ki**  
Tartsd lenyomva 2  
másodpercig

**Intenzitás növelése**  
Nyomd meg röviden  
a (+) gombot

**Intenzitás csökkentése**  
Nyomd meg röviden  
a (-) gombot

**Afterglow**  
Tartsd lenyomva a (-)  
gombot 1 másodpercig



# HASZNÁLATI ÚTMUTATÓ

## 1. Bekapcsolás

Tartsd lenyomva 2 másodpercig.  
A LED jelezni fogva,  
hogy a termék bekapcsolt.

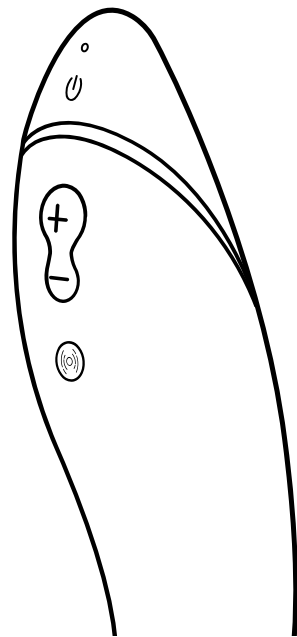

## 2. Használat

A hangulat megteremtéséhez  
először a csiklódon  
használd az **OG**-t.

Kend be az **OG** felületét  
vízalapú síkosítóval.

Ha készen állsz rá, helyezd  
be az **OG**-t, és fedezd fel a G-pontodat!

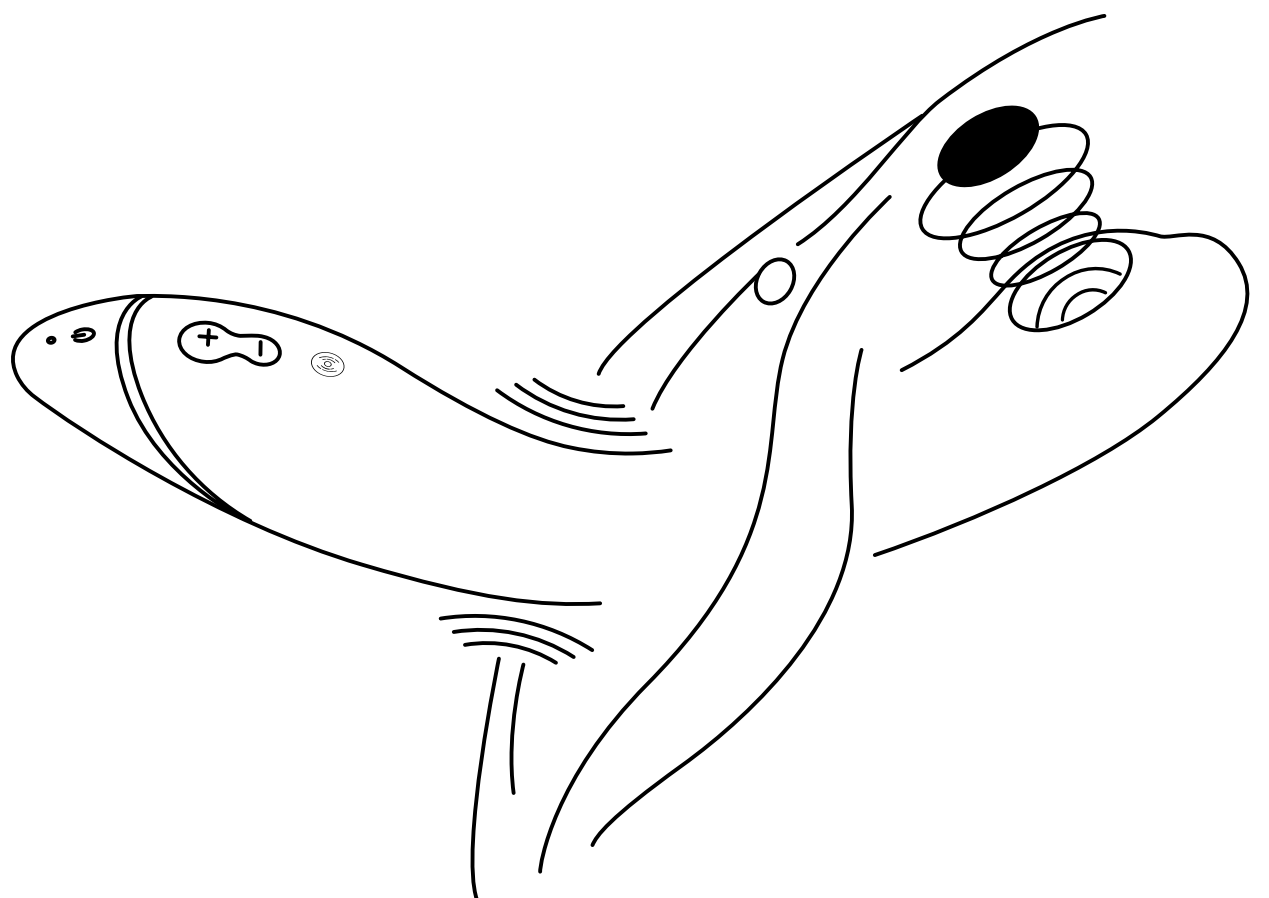
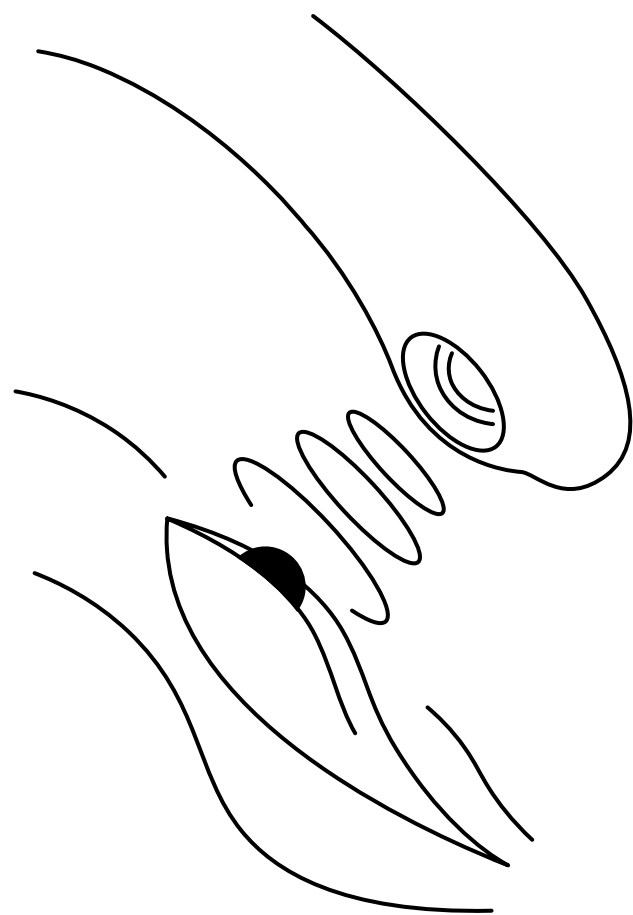

# HASZNÁLATI ÚTMUTATÓ

## 3. Intenzitás módosítása

### Növelés

Nyomd meg röviden  
**12 intenzitási szint**

### Növelés

Nyomd meg röviden  
**3 vibrációs szint**

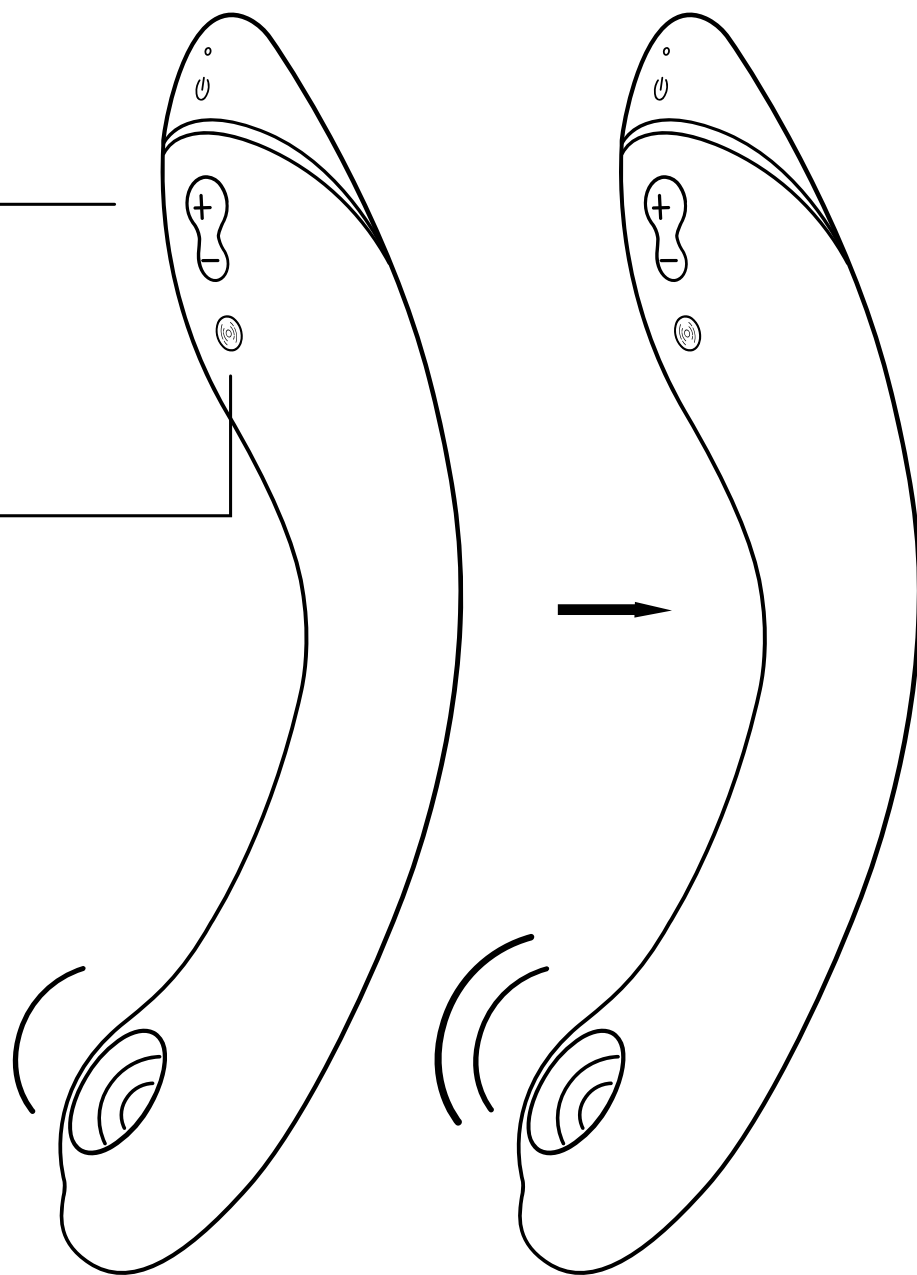

### Csökkentés

Nyomd meg  
röviden

### Afterglow

Az 1. intenzitási szintre  
való visszatéréshez  
tartsd lenyomva  
a (-) gombot 1  
másodpercig

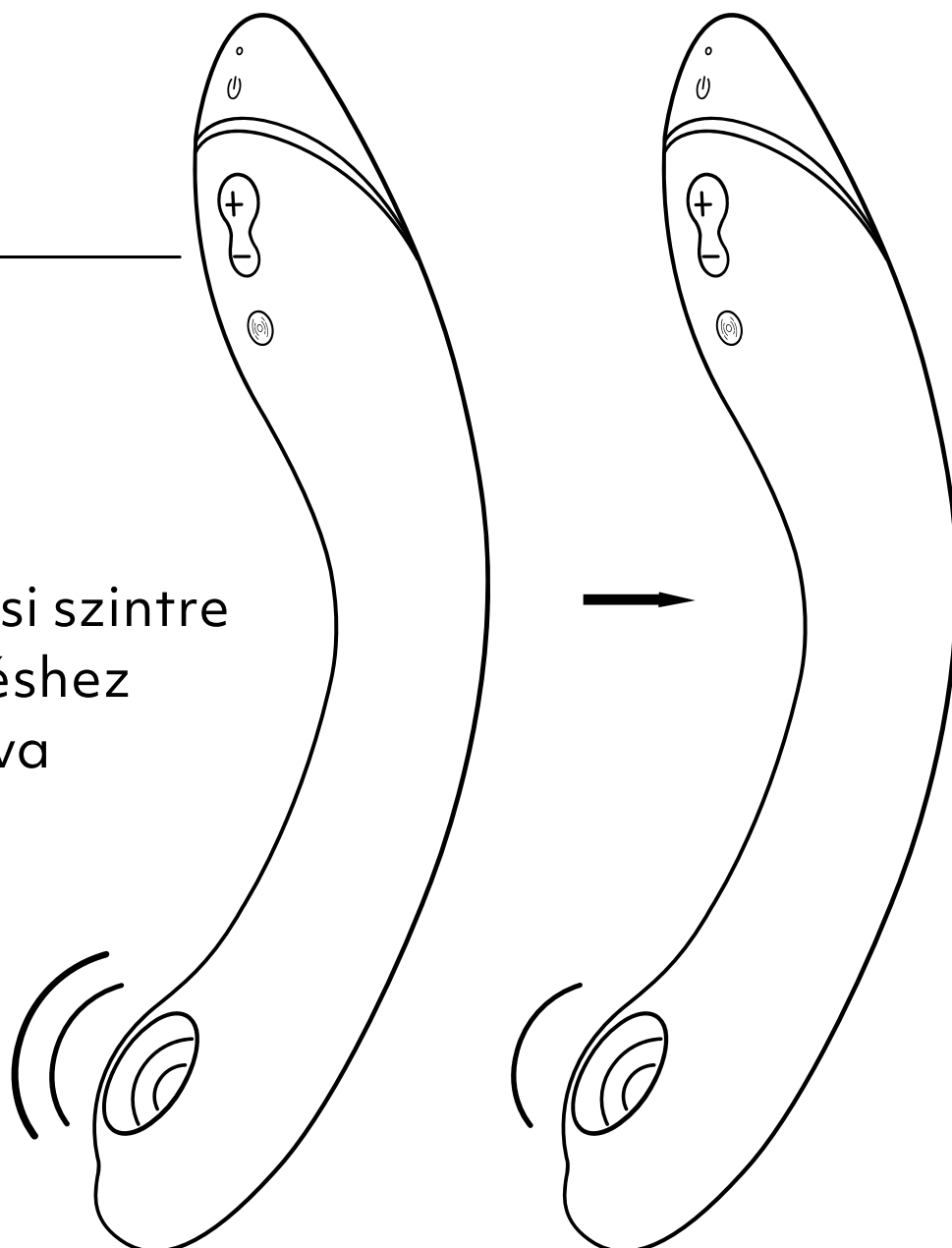

# HASZNÁLATI ÚTMUTATÓ

## 4. Kikapcsolás

Tartsd lenyomva 2 másodpercig

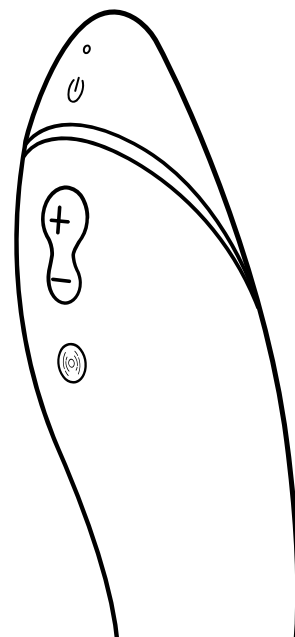

## SMART SILENCE

Az **OG** csak akkor kapcsol be, amikor majdnem hozzáér a bőrhoz. A Smart Silence alapértelmezés szerint bekapcsol. A Smart Silence be- vagy kikapcsolásához tartsd lenyomva 2 másodpercig a plusz és a mínusz gombot.

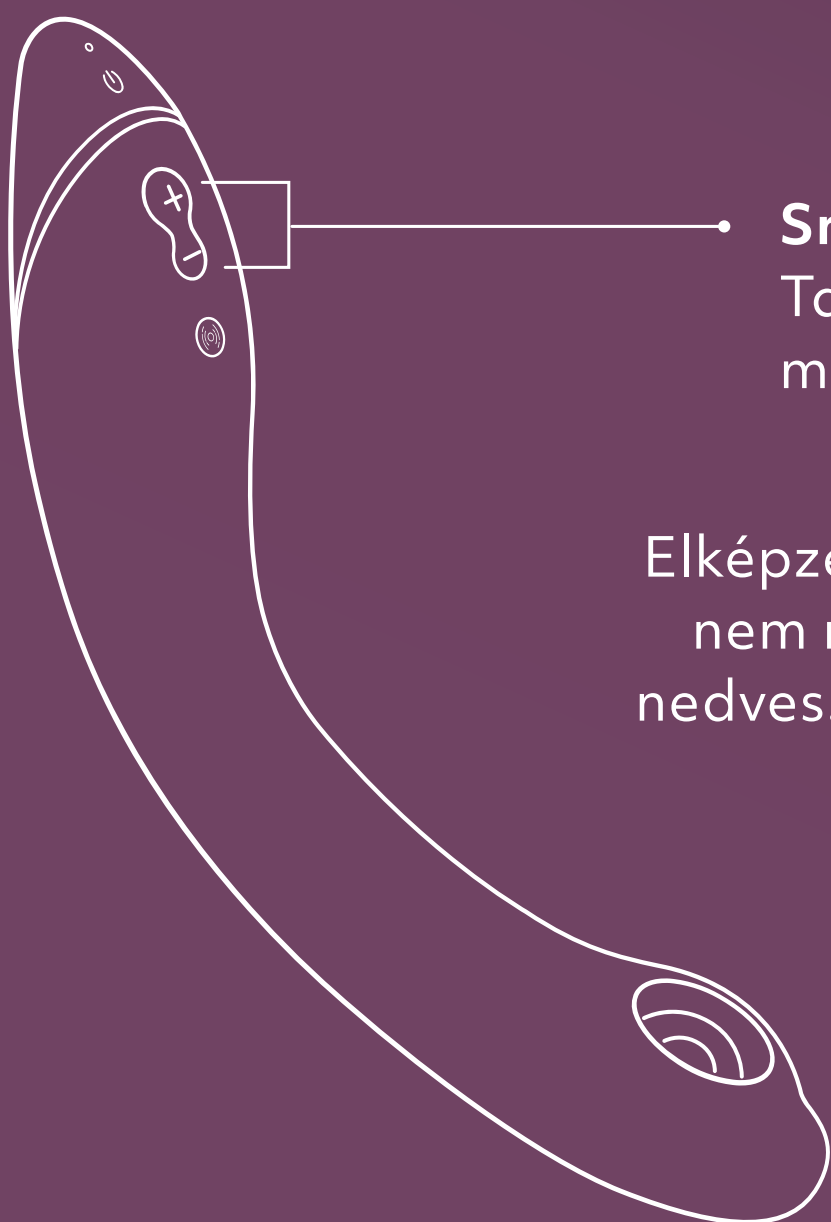

**Smart Silence Be/ki**  
Tartsd lenyomva 2  
másodpercig

Elképzelhető, hogy a Smart Silence nem működik, ha a szívóharang nedves. Ezért a Pleasure Air fejét ne kend be síkosítóval.

# TISZTÍTÁS

Mosd meg víz alatt.

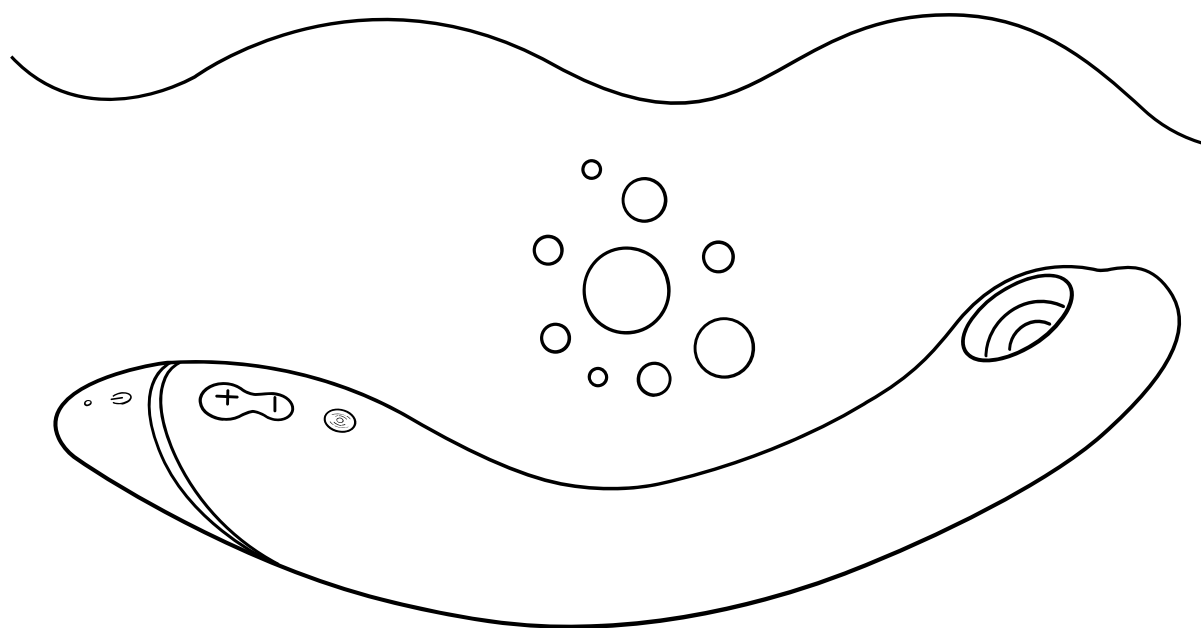

Használd a tisztítószeret.

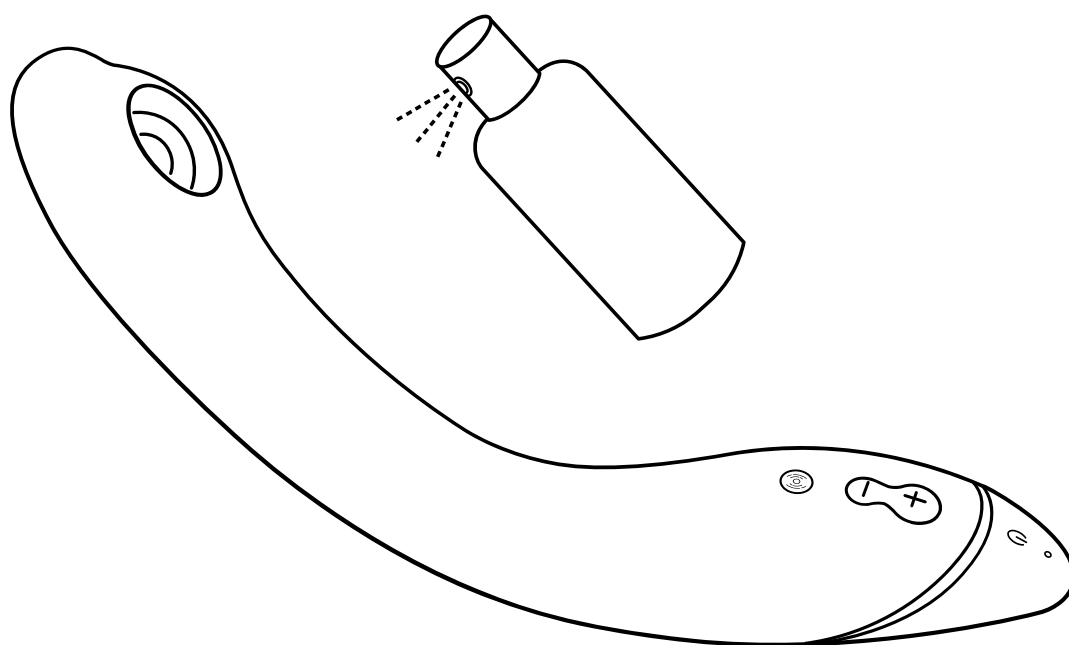

Óvatosan szárítsd meg, ne fejts ki túl nagy nyomást a membránra.

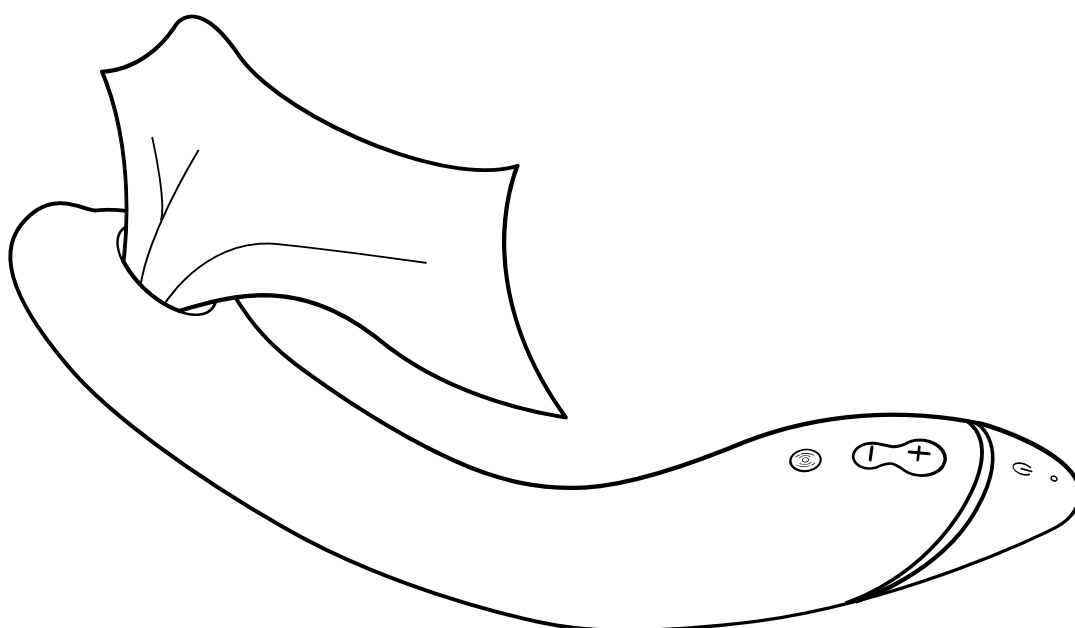

Vízálló (IPX7)

# TÖLTÉS

Az első használat előtt töltsd fel az **OG**-t. A hosszú akkumulátor-élettartam érdekében ne felejtsd el rendszeresen feltölteni az **OG**-t.

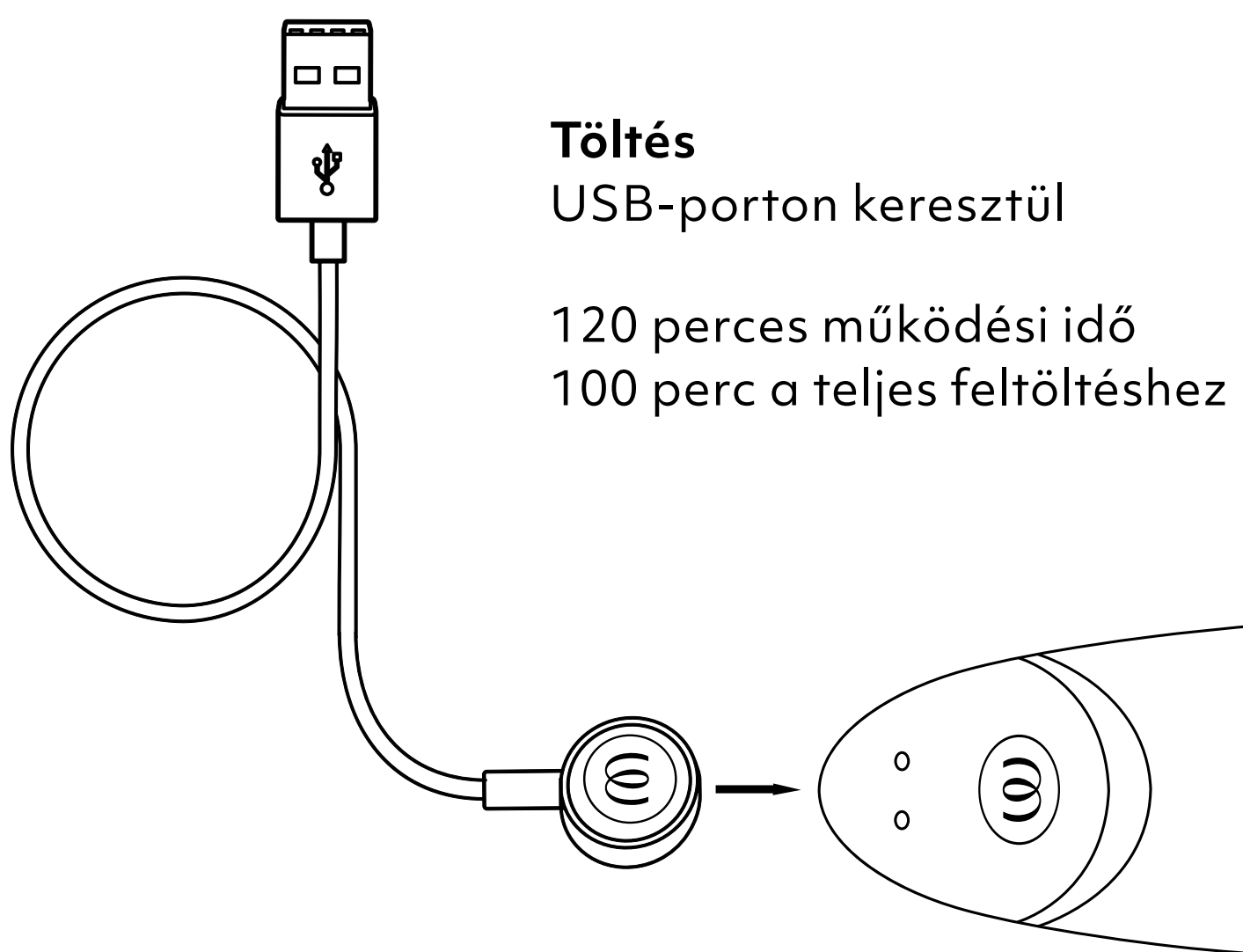

## Töltés

USB-porton keresztül

120 perces működési idő

100 perc a teljes feltöltéshez

---

## LED

Ki/Be/töltés

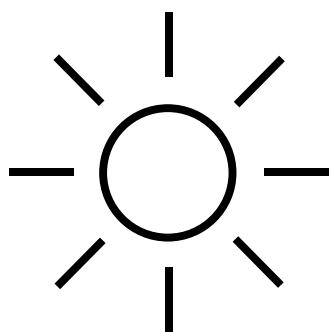

## Teljes feltöltve

A LED folyamatosan világít

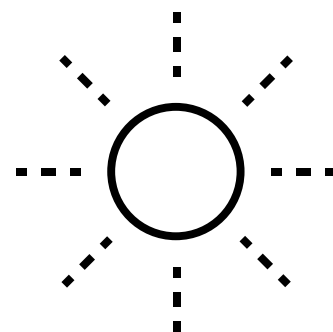

## Töltés

A LED villog



# ÁLTALÁNOS INFORMÁCIÓK

## FIGYELMEZTETÉS

Csak új termékként kerül értékesítésre. A terméket kizárólag rendeltetésszerűen használja. Gyermekektől tartsa távol a terméket. Orvosi célokra nem alkalmas. Amennyiben orvosi kezelés alatt áll és/vagy egészségi állapota orvosi eszköz használatát igényli, a termék használata előtt konzultáljon orvosával. Azonnal hagyja abba a termék használatát, ha bármilyen bőrirritációt, fájdalmat vagy kellemetlen érzést tapasztal, és konzultáljon orvosával.

Ezt az eszközt kizárólag felnőttek használhatják. Korlátozott fizikai, érzékszervi vagy mentális képességű vagy hiányos tapasztalattal és ismeretekkel rendelkező személyek csak felügyelet mellett, vagy akkor használhatják, ha felvilágosítást kaptak az eszköz biztonságos használatát illetően, és megértették az azzal járó kockázatokat. Gyermek nem játszhat az eszközzel. Az eszköz tisztítását és karbantartását nem végezhetik gyermekek. Ne használja duzzadt vagy gyulladt bőrfelületen.

- Használat előtt távolítsa el a piercingeket és ékszereket a nemi szervek területén.
- Mindig tisztítsa meg a készüléket használat előtt és után, a kezelési útmutatóban leírtak szerint.
- A termék károsodásának elkerülése érdekében a terméket és az akkumulátort nem érheti 45°C-nál magasabb hőmérséklet, tilos azt szétszerelni vagy mechanikai, illetve elektromos úton megrongálni.
- A szexuális játékszerek közös használatával átterjedhetnek a szexuális betegségek. Ne engedje, hogy szexuális partnerén és Önön kívül más is használja az Ön szexuális játékszereit. Szükség esetén vezessen be védőintézkedéseket a partnerével. Ne használja a játékszert, ha repedés vagy kopás jeleit észleli a burkolat anyagán.
- A terméket nem anális használatra tervezték. Ne használja análisan!
- A foltok elkerülése érdekében ne helyezze a termék puha oldalát abszorbens felületre.
- Rendszeresen ellenőrizze a töltőt és a szexuális segédeszközt sérülések tekintetében, és ne használja az eszközt, ha bármelyik része sérült.
- A mágneses mezők befolyásolhatják a mechanikus és elektronikus alkatrészeket, például a pacemakereket. Ne használja a készüléket közvetlenül a pacemaker felett. További információért forduljon orvosához. Ne vigyen mágneses csíkokkal ellátott kártyákat (pl. hitelkártyákat) a készülék közelébe, mert azokat a termék mágnesei károsíthatják.
- Amennyiben a szexuális segédeszköz működésében rendellenességet észlel, kapcsolja ki és lépjen kapcsolatba a támogató csoportunkkal a weboldalunkon keresztül.

## A JÁTÉKSZER TÖLTŐKÉSZÜLÉKE

- A töltő használatba vétele előtt ellenőrizze a helyi feszültség szintet, mivel a helyi hálózati feszültség nem haladhatja meg a töltőn feltüntetett maximális hálózati feszültséget.
- Az eszközt kizárólag az azon megjelölt, biztonságos, extra alacsony feszültséggel szabad táplálni.
- Ne használja és ne tisztítsa a terméket, amíg az akkumulátor töltődik.
- Ne merítse vízbe vagy más folyadékba a töltőt vagy a töltőkábelt.
- Az eszköz nem cserélhető elemeket tartalmaz.
- A termék újra feltölthető Li-ion elemet tartalmaz.
- Minden töltési folyamat után húzza ki a töltőkábelt az áramból.

## A TERMÉK MEGFELELŐ HASZNÁLATÁNAK ÉRDEKÉBEN KÖVESSE A KÖVETKEZŐ UTASÍTÁSOKAT:

- Az akkumulátor hosszú élettartamának megőrzése érdekében rendszeresen töltsse fel a készüléket akkor is, ha az nincs használatban.
- A terméket biztonságos, száraz, közvetlen napsugárzástól védett helyen tárolja.
- Vízbázisú síkosító használatát javasoljuk. A készülék károsodásának elkerülése érdekében ne használjon szilikon vagy alkohol bázisú síkosítót, gélt vagy masszázsolajat.

# GENERAL INFORMATION

## ELECTRICAL RATING

**Model:** OG

**Model No.:** TES10A

**Power Input:**

3,7 V=0,62 A: Built-in Li-Polymer rechargeable battery.

5 V=0,5 A: When charged using USB.

Use USB AC adaptor (not included) with power output corresponding to product rating. Use original provided cable only."

## CONTENT OF DELIVERY

Womanizer OG G-Spot vibrator, USB charging cable (AC adapter not included), cotton storage pouch, quick start guide, safety instructions

## ENVIRONMENTAL PROTECTION

As a distributor of electronic devices, we are legally obliged to accept the return of waste electrical and electronic devices free of charge. We expressly state that you as the user are legally obliged to return used batteries.

Never throw away electronic devices or batteries in the household waste. The symbol shown below (crossed-out wheeled bin) is intended to expressly remind you of this.

## MANUFACTURED AND DISTRIBUTED BY

**WOW Tech Europe GmbH**

Hermann-Blankenstein-Strasse 5

10249 Berlin

[www.wowtech.com](http://www.wowtech.com)

WOW Tech Europe GmbH reserves the right to make technical changes and changes to the design that serve to improve the device.

For information regarding patents see [womanizer.com/patents](http://womanizer.com/patents).

## CUSTOMER CARE

[care@womanizer.com](mailto:care@womanizer.com)

[womanizer.com](http://womanizer.com)

Designed in Germany. Made in China.

Date of issue: 10/2022.



# STILL WANT MORE?

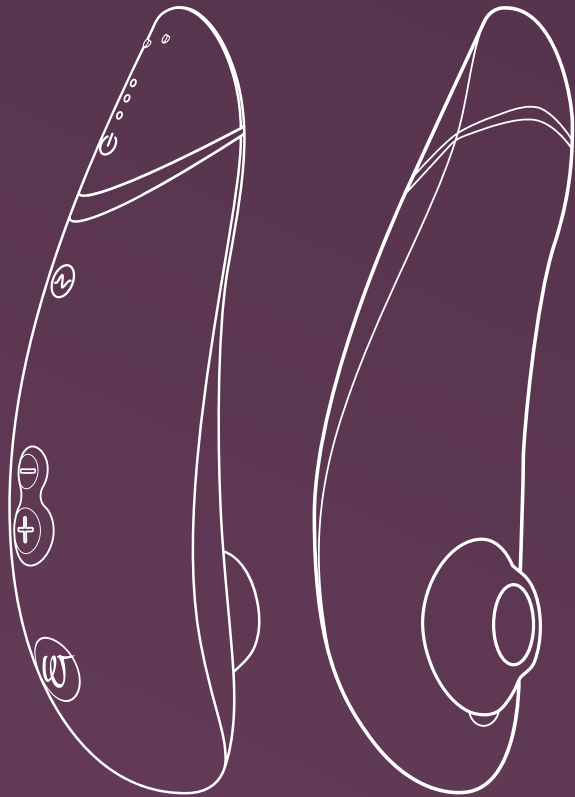

Pleasure Air  
Technology

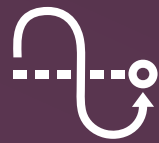

Autopilot



Smart Silence

**Premium 2**  
Define your luxury

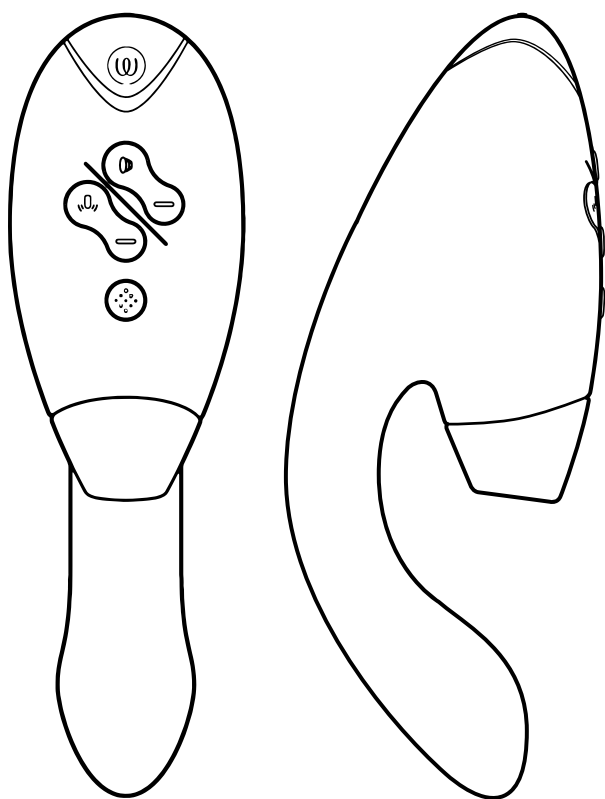

Pleasure Air  
Technology



Double Stimulation



Smart Silence

**DUO 2**  
Indulge in whole-body orgasms



#IMASTURBATE

# Hi!

Ačiū, kad pasirinkote **WOMANIZER**

Sveikos atvykusios į jausmingų patirčių kupiną pasaulį, praturtinsiantį jūsų gyvenimą. Pasirinkusios **WOMANIZER**, jūs ne tik patirsite su niekuo nepalyginamus orgazmus, bet ir sužadinsite naują aistrą malonumams.

Mėgaukitės savuoju **WOMANIZER** ir nesibaigiančiais orgazmais.

Eikite, pamylėkite save!



APRAŠYMAS

KAIP NAUDOTIS

SMART SILENCE

VALYMAS

ĮKROVIMAS

SAFETY INSTRUCTIONS

BENDRA INFORMACIJA

Please read the safety instructions in the  
Compliance & Safety Information before first use.

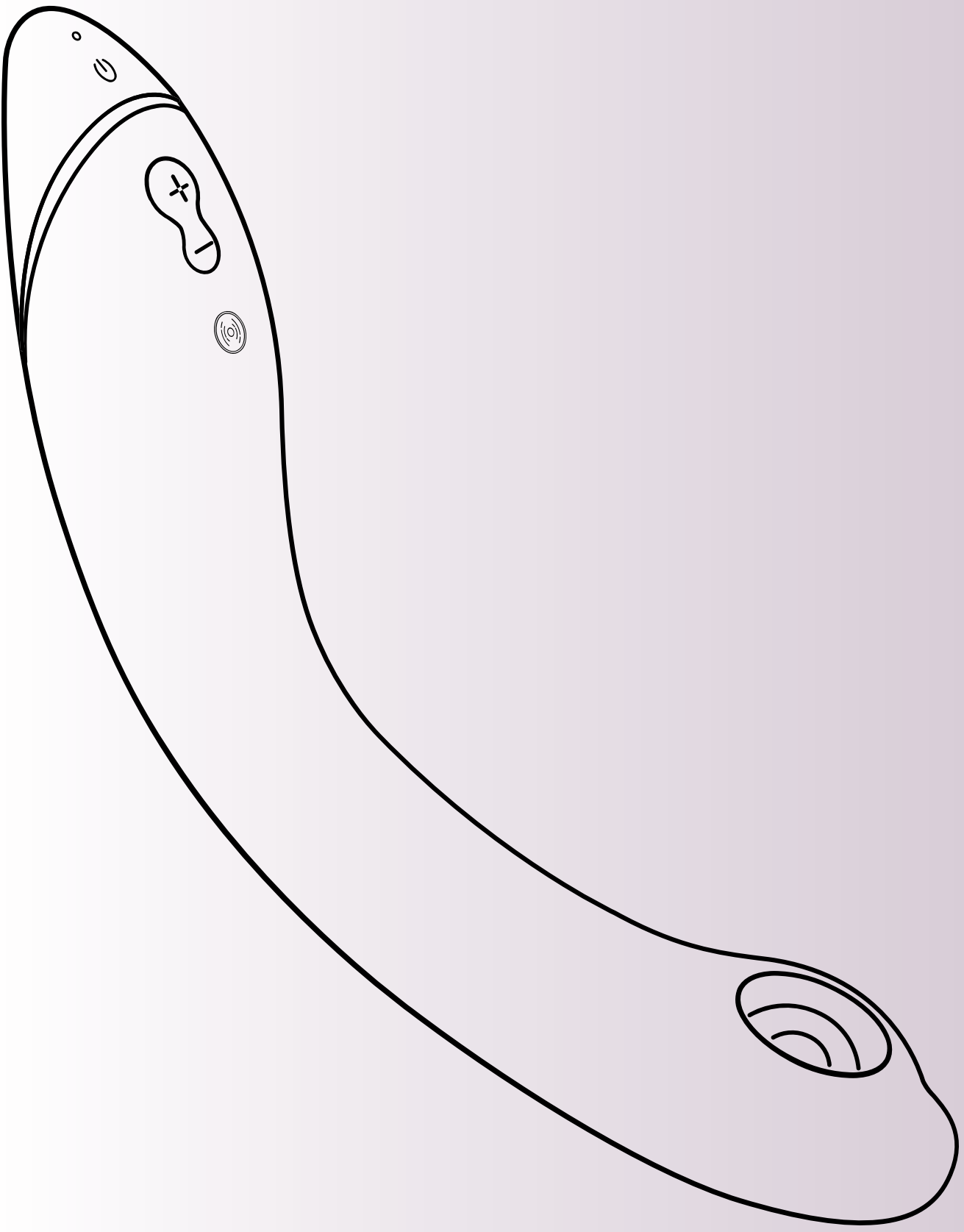

# APRAŠYMAS

**LED švieselė**  
Įjungta/Įkraunama

**Funkcija „Smart Silence“ įjungta/išjungta**  
Paspauskite ir palaikykite 2 sekundes

**Vibravimas**  
Paspauskite, kad aktyvuotumėte ir padidintumėte intensyvumą (3 lygių)

**Pleasure Air Technology**  
12 intensyvumo lygių

**Įjungta/Išjungta**  
Paspauskite ir palaikykite 2 sekundes

**Padidinkite intensyvumą**  
Paspauskite (+)

**Sumažinkite intensyvumą**  
Paspauskite (-)

**Funkcija „Afterglow“**  
Paspauskite (-) ir palaikykite 1 sekundę





# KAIP NAUDOTIS

## 1. Įjunkite

Paspauskite ir palaikykite 2 sekundes LED švieselė parodys, kad produktas yra įjungtas.

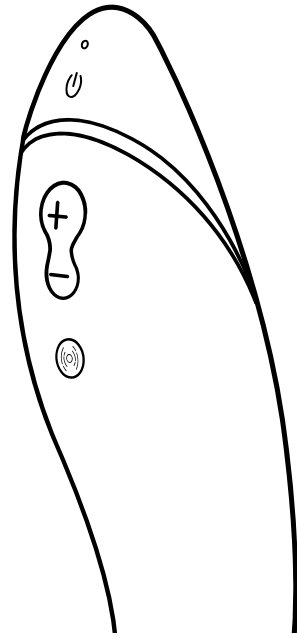

## 2. Naudojimas

Kad labiau įsijaustumėte, pirmiausia išbandykite **OG** vibratorių ant savo klitorio.

Užtepkite vandens pagrindo lubrikantą ant **OG** vibratoriaus.

Kai pasijausite pasiruošusi, įsikiškite **OG** vibratorių ir tyrinėkite savo G tašką!

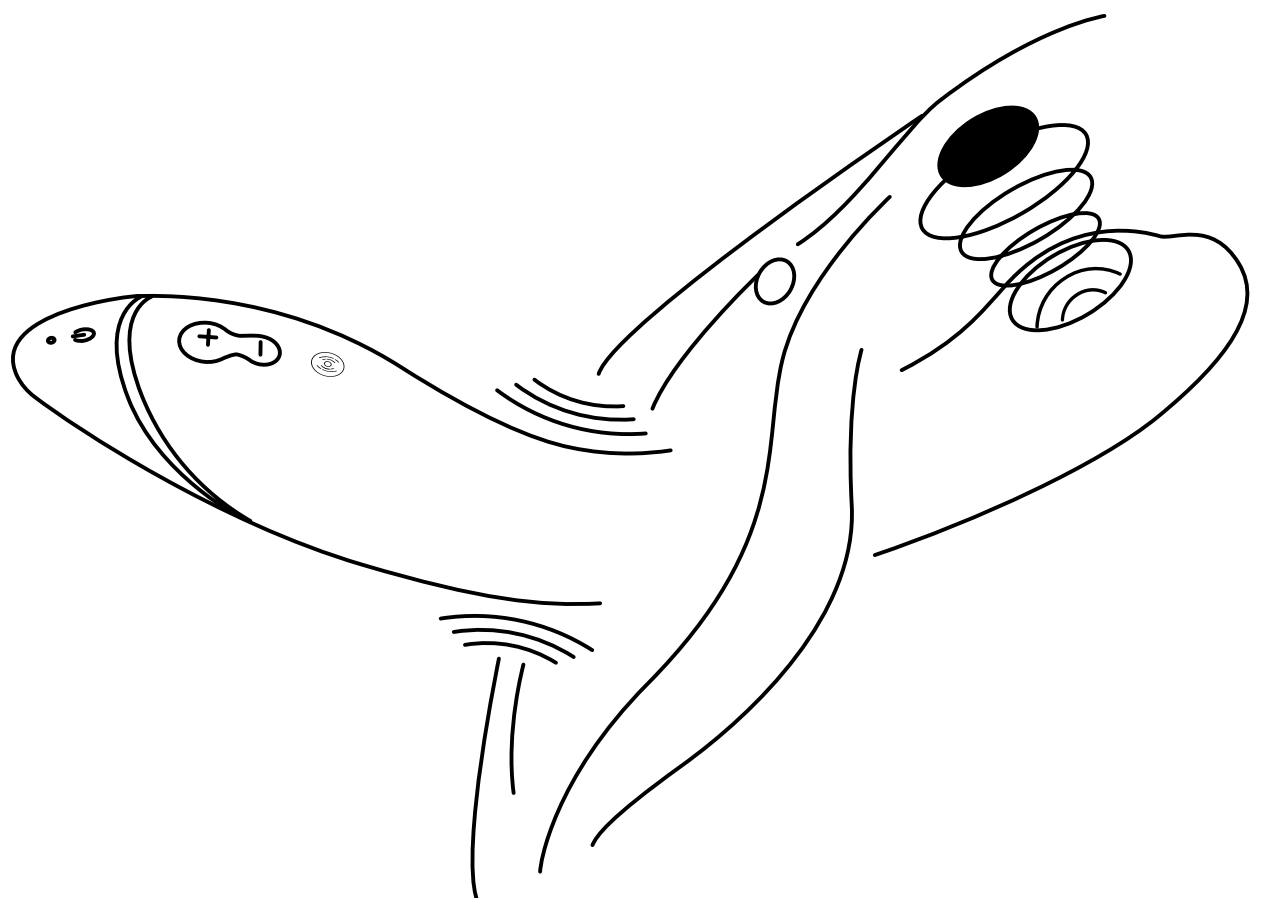
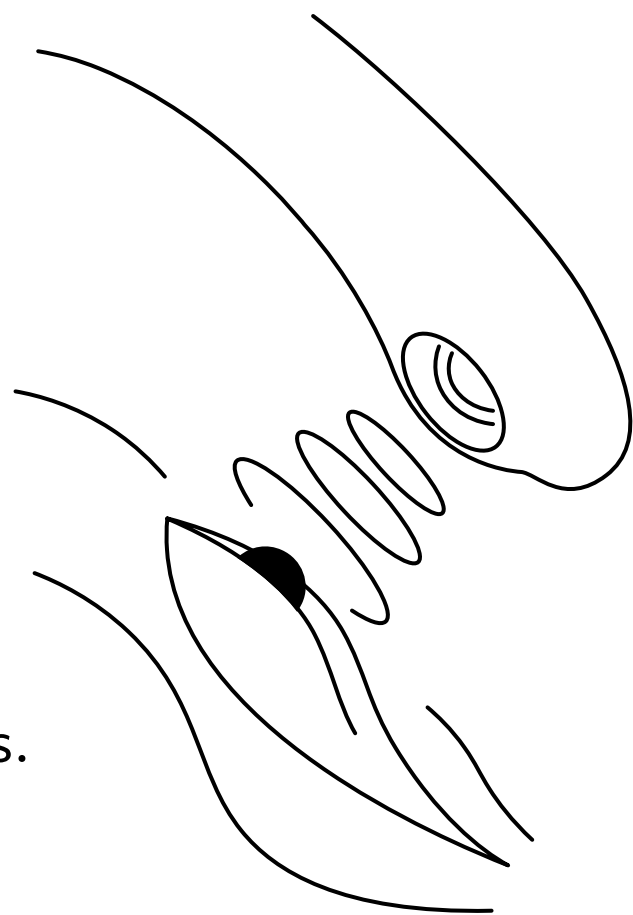

# KAIP NAUDOTIS

## 3. Pakeiskite intensyvumą

**Padidinkite** —  
Paspauskite  
**12 intensyvumo lygių**

**Padidinkite** —  
Paspauskite  
**3 vibracijos lygiai**

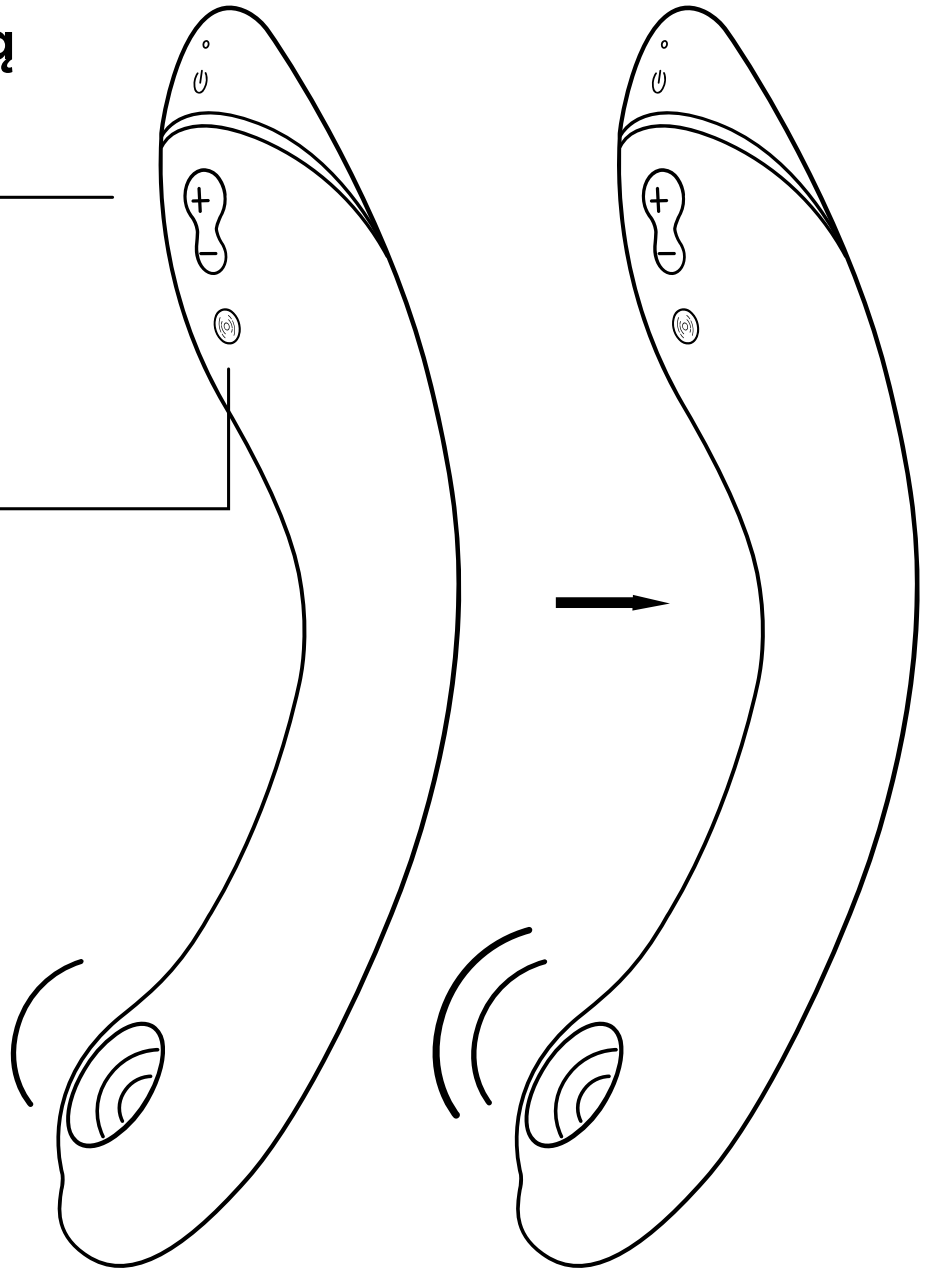

**Sumažinkite** —  
Paspauskite

**Funkcija „Afterglow“**  
Paspauskite (-) ir  
palaikykite 1 sekundę,  
kad grįžtumėte prie  
pirmo intensyvumo  
lygio

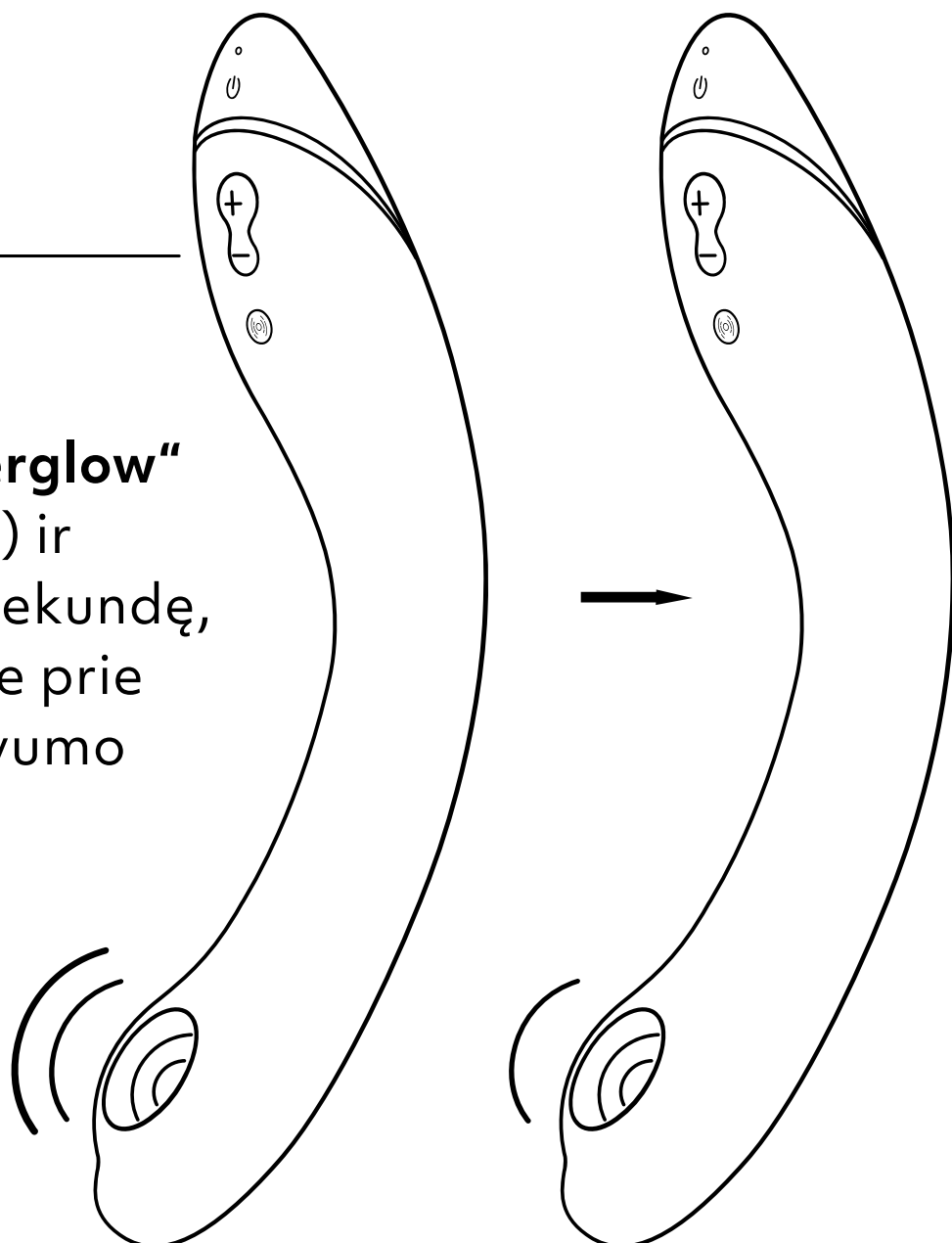

# KAIP NAUDOTIS

## 4. Išjunkite

Paspauskite ir  
palaikykite 2 sekundes

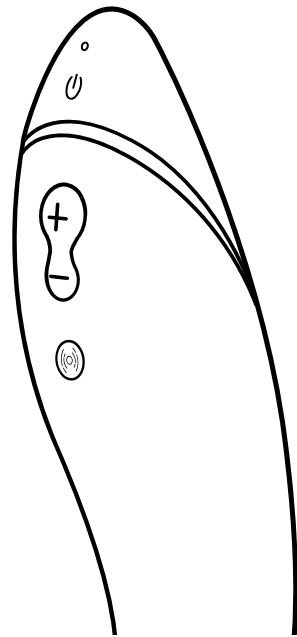

## SMART SILENCE

**OG** vibratorius įsijungia tik tada, kai beveik liečiasi prie odos. Funkcija „Smart Silence“ įsijungs pati pagal numatytuosius nustatymus. Paspauskite ir 2 sekundes palaikykite (+) ir (-) mygtukus, kad įjungtumėte ar išjungtumėte „Smart Silence“.



### Smart Silence Įjungta/Išjungta

Paspauskite ir palaikykite 2  
sekundes

Funkcija „Smart Silence“ gali neveikti, jeigu stimuliavimo galvutė yra drėgna. Todėl įsitikinkite, kad lubrikantas nėra užteptas ant „Pleasure Air“ galvutės.

# VALYMAS

Plaukite su vandeniu.

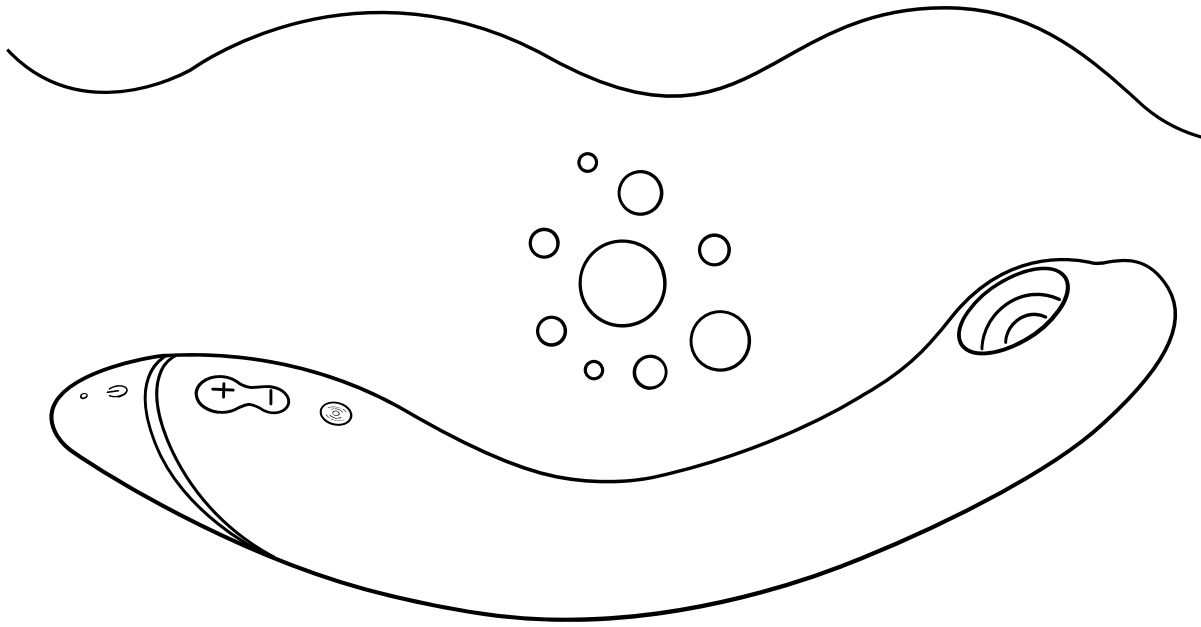

Valykite su sekso prekių valikliu.

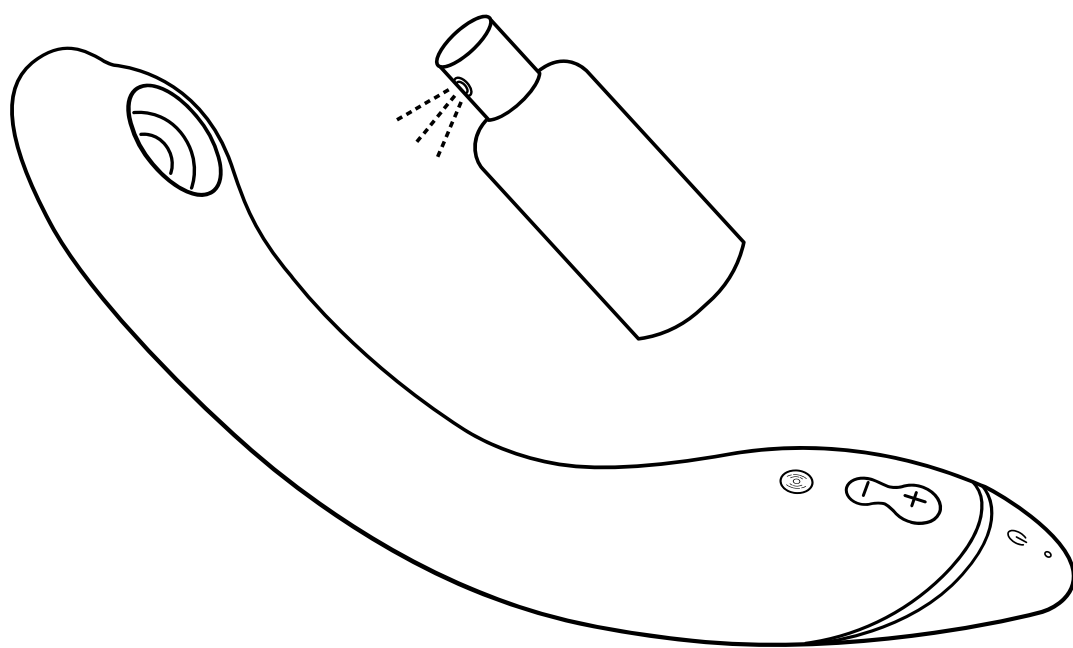

Atsargiai nusausinkite per daug nespausdamos membranos.

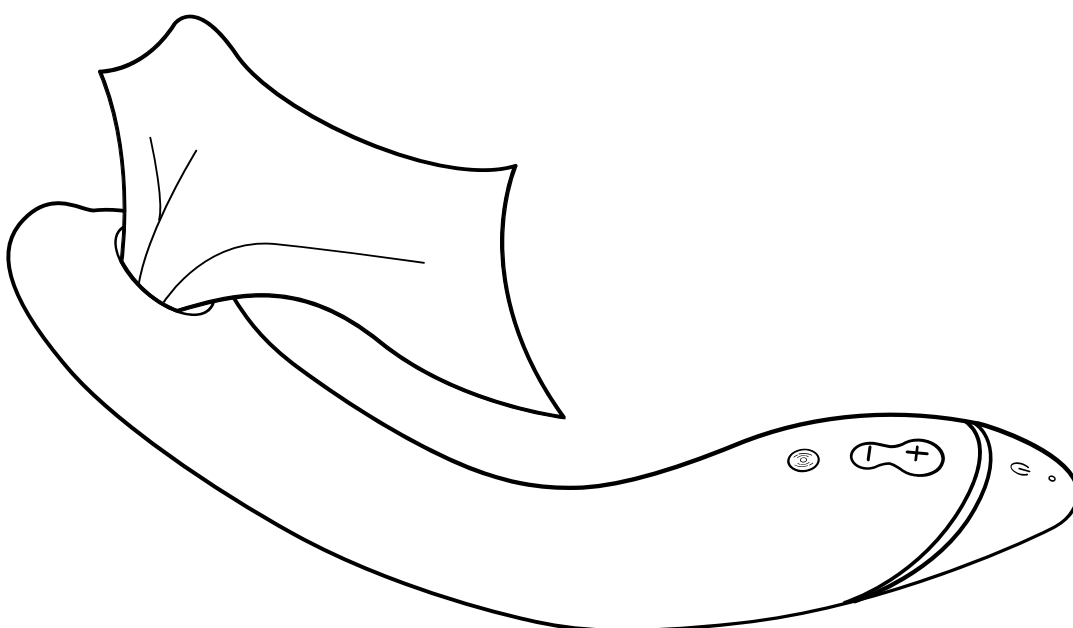

Vandeniui atsparus  
(IPX7)

# ĮKROVIMAS

Pakraukite **OG** vibratorių prieš naudojantis pirmą kartą. Taip pat nepamirškite reguliariai pakrauti **OG** vibratoriaus, kad užtikrintumėte baterijos ilgaamžiškumą.

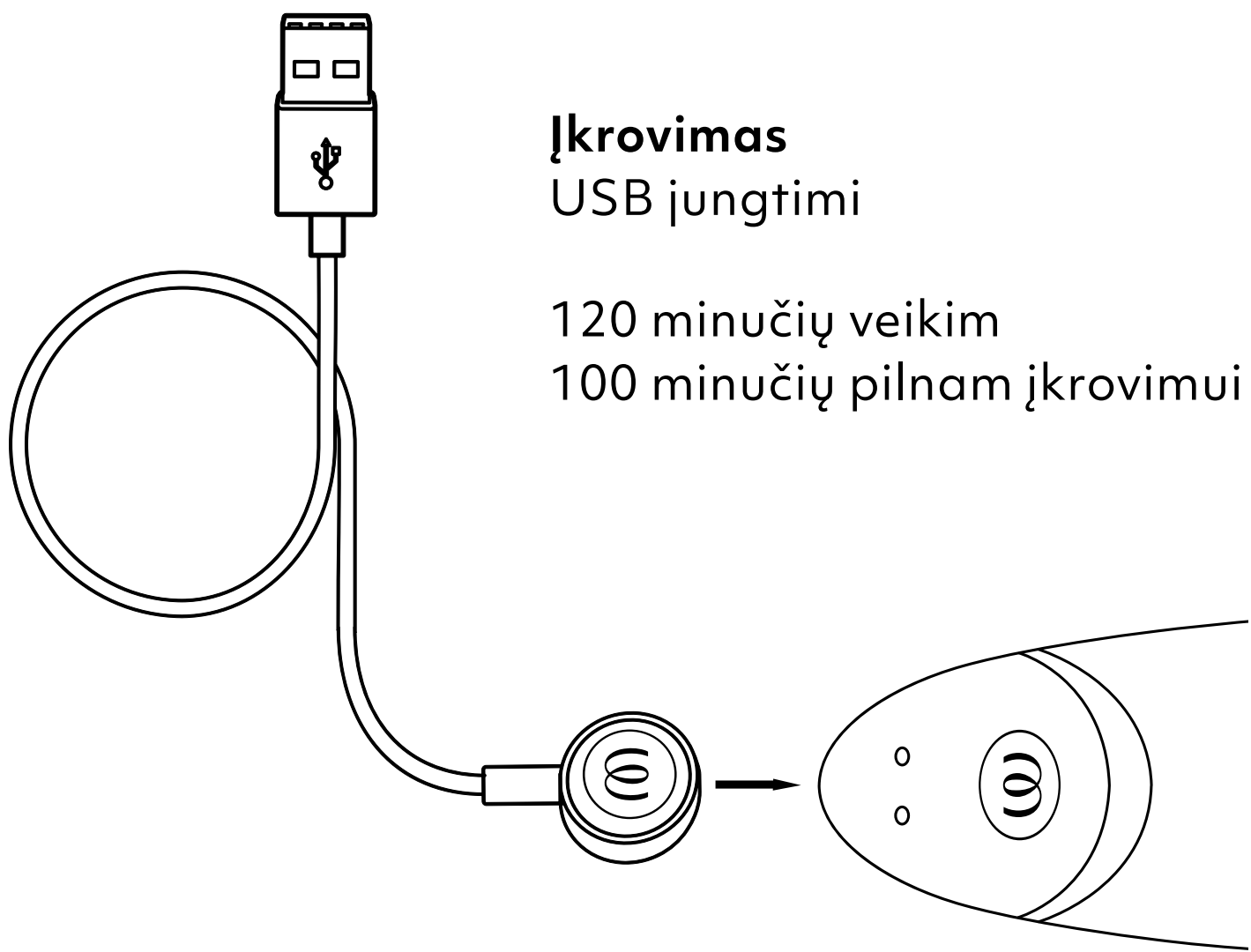

## Įkrovimas

USB jungtimi

120 minučių veikim

100 minučių pilnam įkrovimui o

---

## LED

Įjungta / Išjungta / Įkraunama

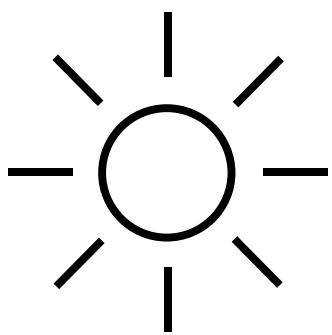

### Iki galo įkrautas

LED švieselė nuolat įsijungia

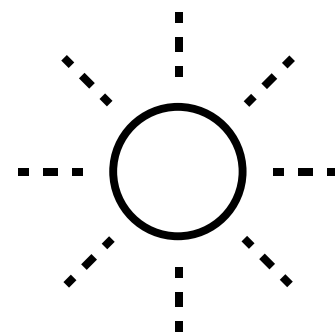

### Įkrovimas

LED švieselė mirksi

# SAFETY INSTRUCTIONS

## PERSPĖJIMAS

Parduodamas tik kaip naujas produktas. Produktą naudokite tiktai pagal jo numatytąją paskirtį. Laikykite gaminį vaikams neprieinamoje vietoje. Netinka medicinos tikslams. Jei esate gydytojų priežiūroje ir (arba) jūsų būklei palaikyti reikalingas medicininis prietaisas, prieš pradėdami naudoti šį gaminį pasitarkite su savo gydytoju. Iš karto nutraukite naudojimąsi gaminiu, jei pastebėjote odos sudirgimą, skausmą ar pajutote diskomfortą, ir pasitarkite su savo gydytoju.

Prietaisas yra skirtas naudoti tiktai suaugusiems asmenims; asmenys su ribotais fiziniais, sensoriniais ar protiniais gebėjimais arba neturintys naudojimo patirties gali naudotis prietaisu tiktai tinkamai instruktuoti arba prižiūrėti, kad prietaisu naudotųsi saugiai ir suprastų susijusias rizikas. Vaikai neturi žaisti su prietaisu. Vaikai neturi valyti prietaiso ir atlikti jo priežiūras. Nenaudokite ant patinusios ar uždegimo apimtos odos vietos.

- Prieš naudojimą lytinių organų srityje nuimkite auskarus ir papuošalus.
- Prieš ir po naudojimo visada išvalykite gaminį pagal naudojimo instrukcijoje pateiktus nurodymus.
- Vengiant gaminio pažeidimų, nei jis, nei įkrovimo įtaisas negali būti veikiami aukštesnės kaip 45 °C temperatūros, jų negalima ardyti, pažeisti mechaniškai arba elektriniu būdu.
- Sekso žaislai, kai juos naudojate bendrai, gali pernešti lytiniu būdu perduodamas ligas. Nesidalinkite savo sekso žaislais su niekuo kitu, tik su savo partneriu. Pagal poreikį su partneriu naudokite atitinkamas apsaugos priemones. Nenaudokite žaislo, jei ant dengiamosios medžiagos aptinkate įtrūkimų ar nusidėvėjimo požymių.
- Šis produktas neskirtas analiniam naudojimui. Nenaudoti analinėje angoje!
- Nedėkite prietaiso minkštosios pusės ant sugeriančio paviršiaus, kad neatsirastų dėmių.
- Reguliariai tikrinkite, ar nėra įkrovimo įtaiso ir gaminio pažeidimų ir nenaudokite gaminio, jei pažeisti kurie nors jo komponentai.
- Magnetiniai laukai gali paveikti mechaninius ir elektroninius komponentus, tokius kaip širdies stimulatoriai. Nenaudokite prietaiso tiesiai virš širdies stimulatoriaus. Norėdami gauti daugiau informacijos, kreipkitės į savo gydytoją. Nelaikykite kortelių su magnetinėmis juostelėmis (pvz., kredito kortelės) šalia įrenginio, nes jas gali sugadinti gaminio magnetai.
- Jei pastebėjote, kad jūsų žaislas veikia neįprastai, išjunkite jį ir per mūsų interneto svetainę pasikonsultuokite su klientų palaikymo skyriumi.

## ĮKRAUNAMA

- Prieš naudodami įkrovimo prietaisą pirmą kartą patikrinkite vietinės įtampos lygį, nes vietinis elektros tinklas negali viršyti ant įkrovimo prietaiso nurodytos maksimalios leistinos elektros įtampos.
- Prietaisą galima įkrauti tik saugioje itin žemoje įtampoje, atitinkančioje nuorodą ant prietaiso.
- Nenaudokite ir nevalykite gaminio, kol įkraunama baterija.
- Niekada nenardinkite įkrovimo prietaiso ar įkrovimo laidą į vandenį ar kitą skystį.
- Šiame prietaise esančios baterijos nėra keičiamos.
- Šiame prietaise įtaisyta pakartotinai įkraunama ličio jonų baterija.
- Po kiekvieno įkrovimo atjunkite įkrovimo laidą nuo grandinės.

## OPTIMALIAM GAMINIO NAUDOJIMUI PRAŠOME LAIKYTIS TOLIAU PATEIKTŲ GAIRIŲ:

- Siekiant užtikrinti ilgą baterijos tarnavimo laiką, reguliariai įkraukite prietaisą, net kai jis nenaudojamas.
- Laikykite saugioje sausoje vietoje, apsaugotoje nuo tiesioginių saulės spindulių.
- Savo žaislui rekomenduojame naudoti lubrikantą vandens pagrindu. Vengiant gedimų, nenaudokite aromatizuoto, silikono ar alkoholio pagrindu pagamintų lubrikantų, gelių ar masažinių aliejų.

# GENERAL INFORMATION

## ELECTRICAL RATING

**Model:** OG

**Model No.:** TES10A

**Power Input:**

3,7 V=0,62 A: Built-in Li-Polymer rechargeable battery.

5 V=0,5 A: When charged using USB.

Use USB AC adaptor (not included) with power output corresponding to product rating. Use original provided cable only."

## CONTENT OF DELIVERY

Womanizer OG G-Spot vibrator, USB charging cable (AC adapter not included), cotton storage pouch, quick start guide, safety instructions

## ENVIRONMENTAL PROTECTION

As a distributor of electronic devices, we are legally obliged to accept the return of waste electrical and electronic devices free of charge. We expressly state that you as the user are legally obliged to return used batteries.

Never throw away electronic devices or batteries in the household waste. The symbol shown below (crossed-out wheeled bin) is intended to expressly remind you of this.

## MANUFACTURED AND DISTRIBUTED BY

**WOW Tech Europe GmbH**

Hermann-Blankenstein-Strasse 5

10249 Berlin

[www.wowtech.com](http://www.wowtech.com)

WOW Tech Europe GmbH reserves the right to make technical changes and changes to the design that serve to improve the device.

For information regarding patents see [womanizer.com/patents](http://womanizer.com/patents).

## CUSTOMER CARE

[care@womanizer.com](mailto:care@womanizer.com)

[womanizer.com](http://womanizer.com)

Designed in Germany. Made in China.

Date of issue: 10/2022.



# STILL WANT MORE?

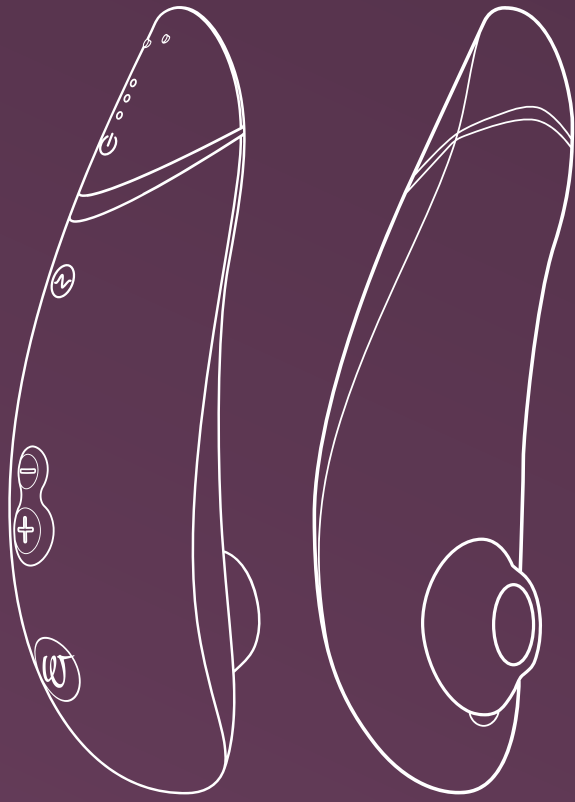

Pleasure Air  
Technology

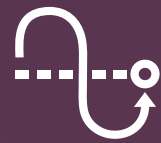

Autopilot



Smart Silence

**Premium 2**  
Define your luxury

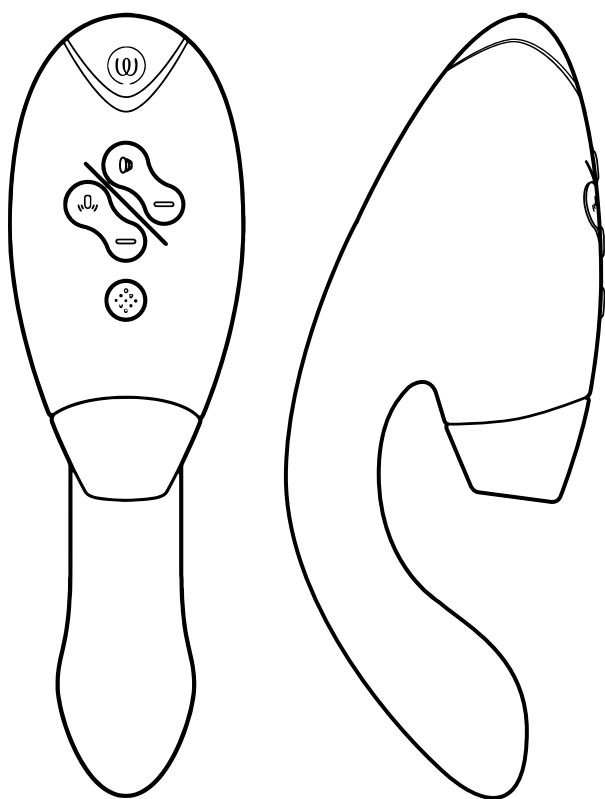

Pleasure Air  
Technology



Double Stimulation

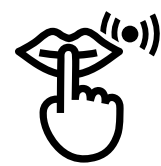

Smart Silence

**DUO 2**  
Indulge in whole-body orgasms





#IMASTURBATE

# Hi!

Paldies, ka izvēlējāties **WOMANIZER**!

Priecājamies jūs redzēt ar jutekliskām niansēm bagātinātā pasaulē, kas piešķirs jūsu dzīvei citas krāsas. Izvēloties **WOMANIZER**, iegūsit ne vien garantētus orgasmus līdz šim nebijušā intensitātē, bet arī citādu vēlmi pēc baudas.

Izbaudiet **WOMANIZER** un vairākkārtējus orgasmus.

Mīliet sevi!



APRAKSTS

LIETOJUMS

SMART SILENCE

TĪRĪŠANA

UZLĀDE

SAFETY INSTRUCTIONS

VISPĀRĪGA INFORMĀCIJA

Please read the safety instructions in the  
Compliance & Safety Information before first use.

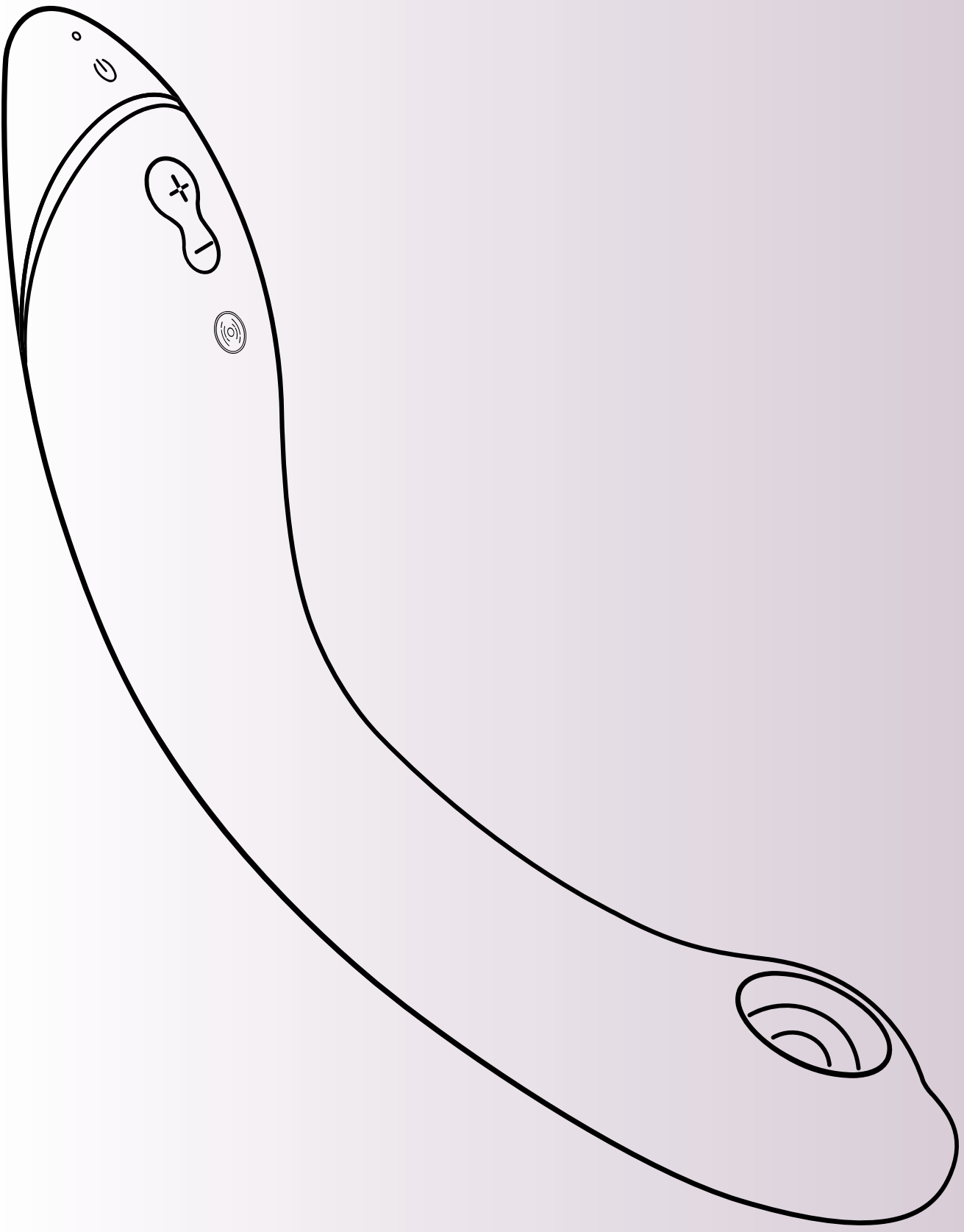

# APRAKSTS

**LED displejs**  
Ieslēgšana/uzlāde

**Smart Silence**  
iesl./izsl.a  
Nospiest 2 sekundes

**Vibrācija**  
Īsi nospiediet,  
lai aktivizētu  
un palielinātu  
intensitāti  
(3 līmeņi)

**Pleasure Air Technology**  
12 intensitātes līmeņi

**Ieslēgt/izslēgt**  
Nospiest 2 sekundes

**Palielināt intensitāti**  
Īsi nospieš (+)

**Samazināt intensitāti**  
Īsi nospieš (-)

**Atblāzma (Afterglow)**  
1 sekundi nospiediet (-)



# LIETOJUMS

## 1. Ieslēgšana

Nospiest 2 sekundes  
LED gaismiņa parādīs, ka  
ierīce ir ieslēgta.

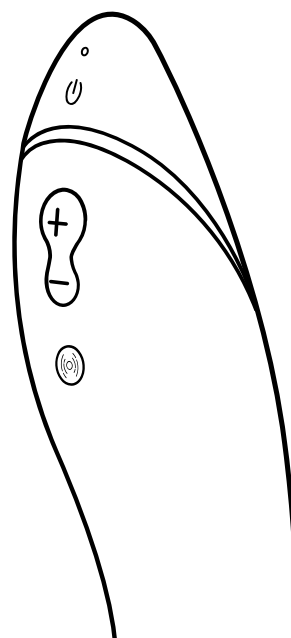

## 2. Lietojums

Lai sasniegtu  
noskaņojumu, vispirms ar  
**OG** kairiniet klitoru.

Uz **OG** korpusa uzklāji  
lubrikantu uz ūdens  
bāzes.

Pēc iesildīšanās ievietojiet  
**OG** un izpētiet G punktu!

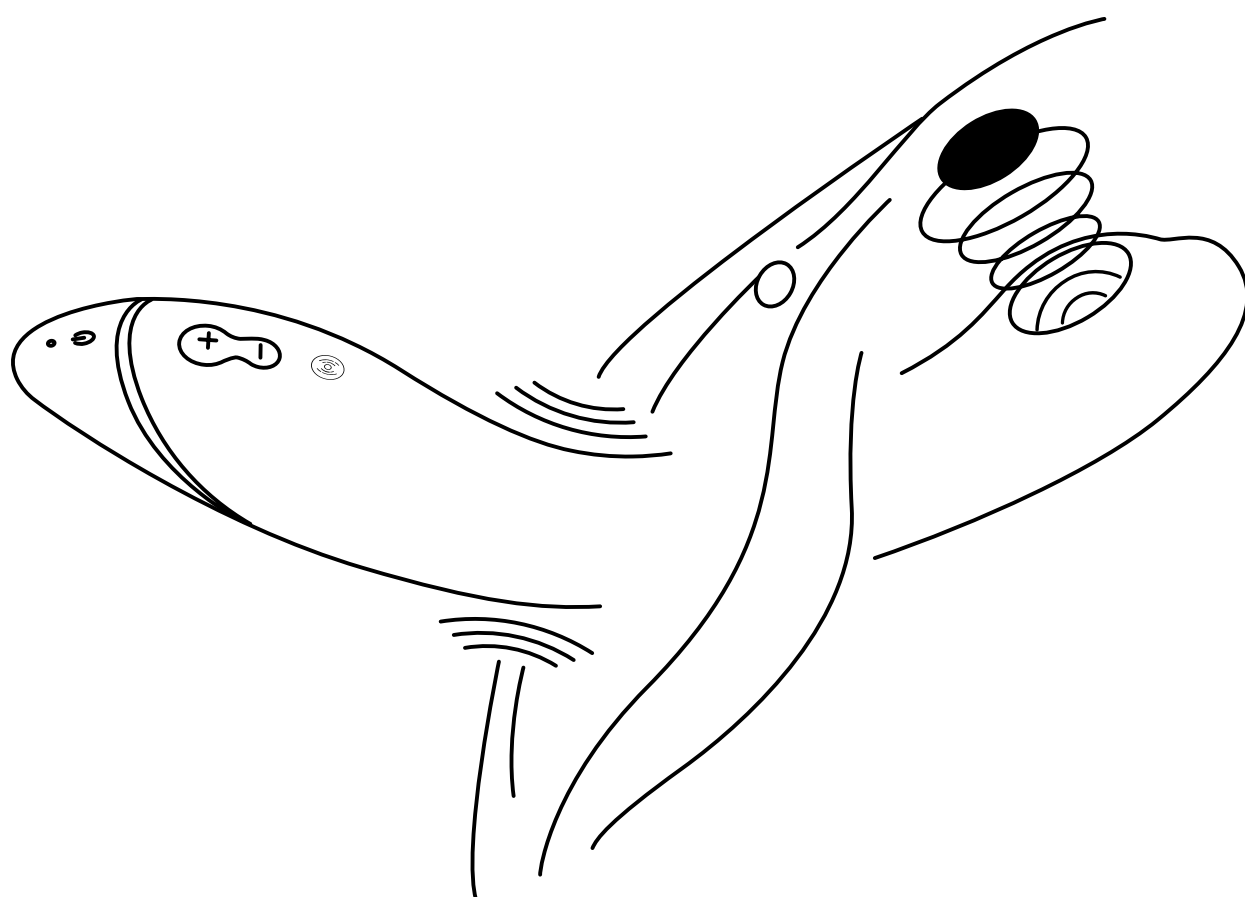
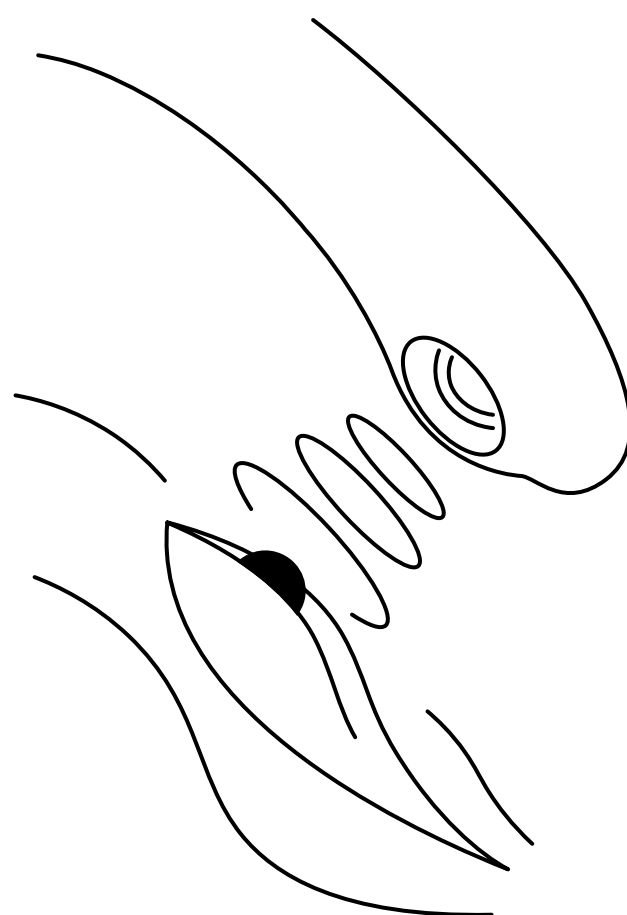

# LIETOJUMS

## 3. Intensitātes maiņaintensyvumā

**Palielināt** —  
Īsi nospieš  
**12 intensitātes līmeņus**

**Palielināt** —  
Īsi nospieš  
**3 vibrācijas līmeņi**

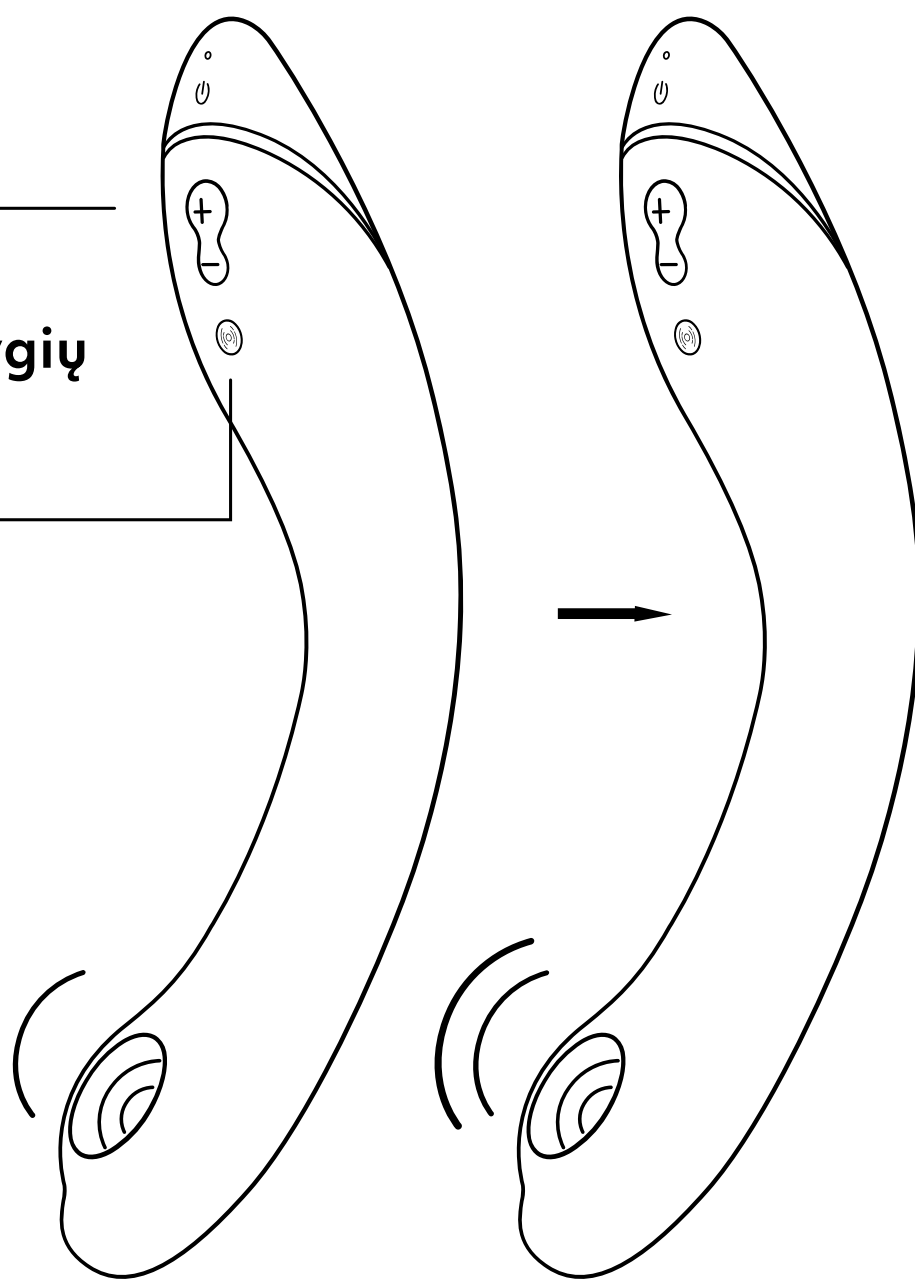

**Samazināt** —  
Īsi nospieš

**Atblāzma  
(Afterglow)**  
Uz 1 sekundi  
nospiediet (-),  
lai atgrieztos  
1. intensitātes līmenī

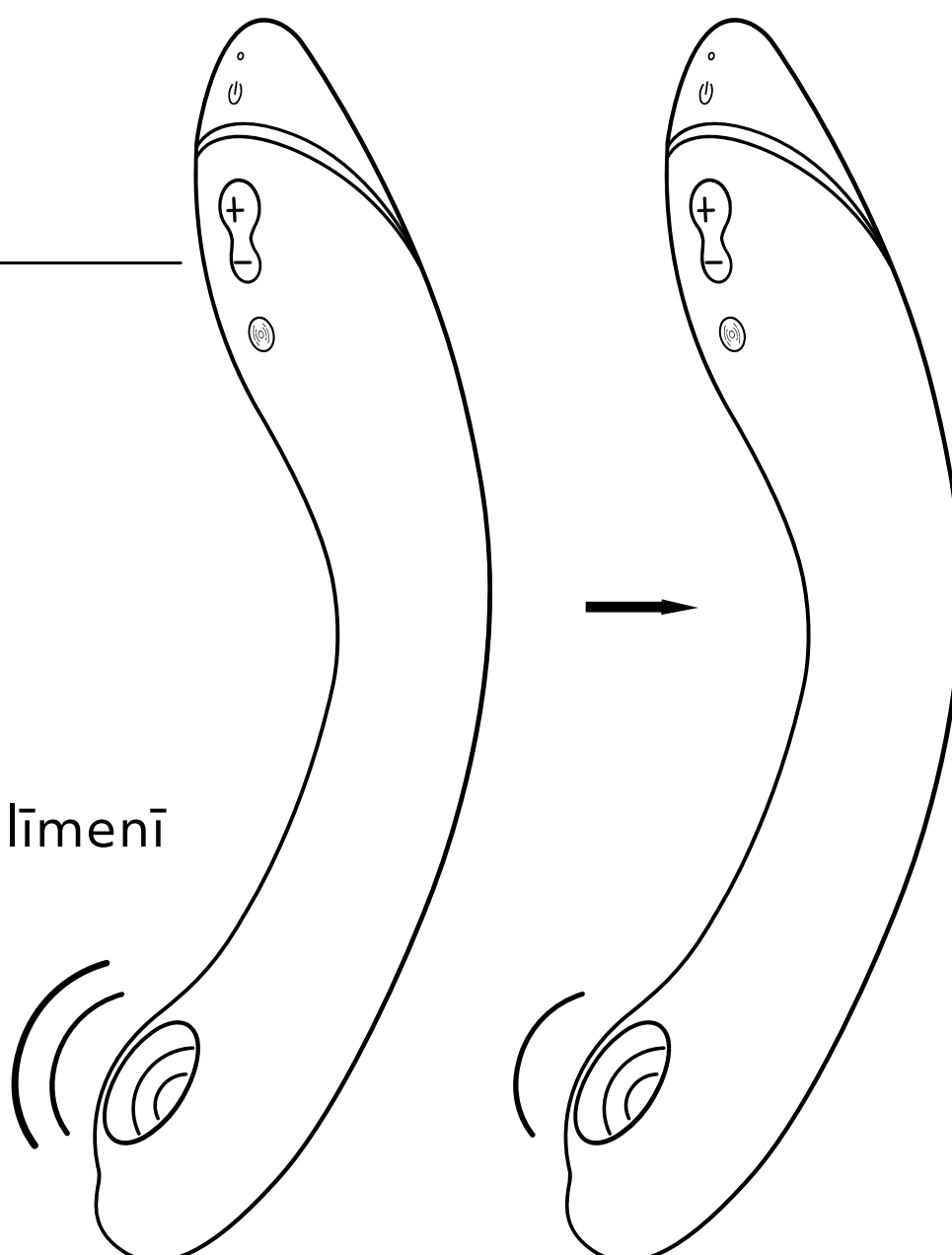

# LIETOJUMS

## 4. Izslēgšana

Nospieš 2 sekundes

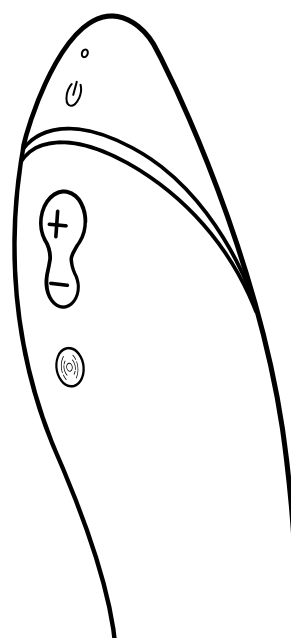

## SMART SILENCE

Vienums **OG** tiek ieslēgts tikai tad, kad tas gandrīz saskaras ar ādu. Vienums Smart Silence tiks ieslēgts pēc noklusējuma. Lai ieslēgtu vai izslēgtu Smart Silence, nospiediet un 2 sekundes turiet nospieštas plusa un mīnusa pogas.



### Smart Silence Ieslēgt/izslēgt

Nospieš 2 sekundes

Ja stimulēšanas galviņa ir slapja, Smart Silence, iespējams, nedarbosies. Tāpēc gādāiet, lai lubrikants neiekļūst tehnoloģijas Pleasure Air galviņā.



# TĪRĪŠANA

Mazgājiet zem ūdens.

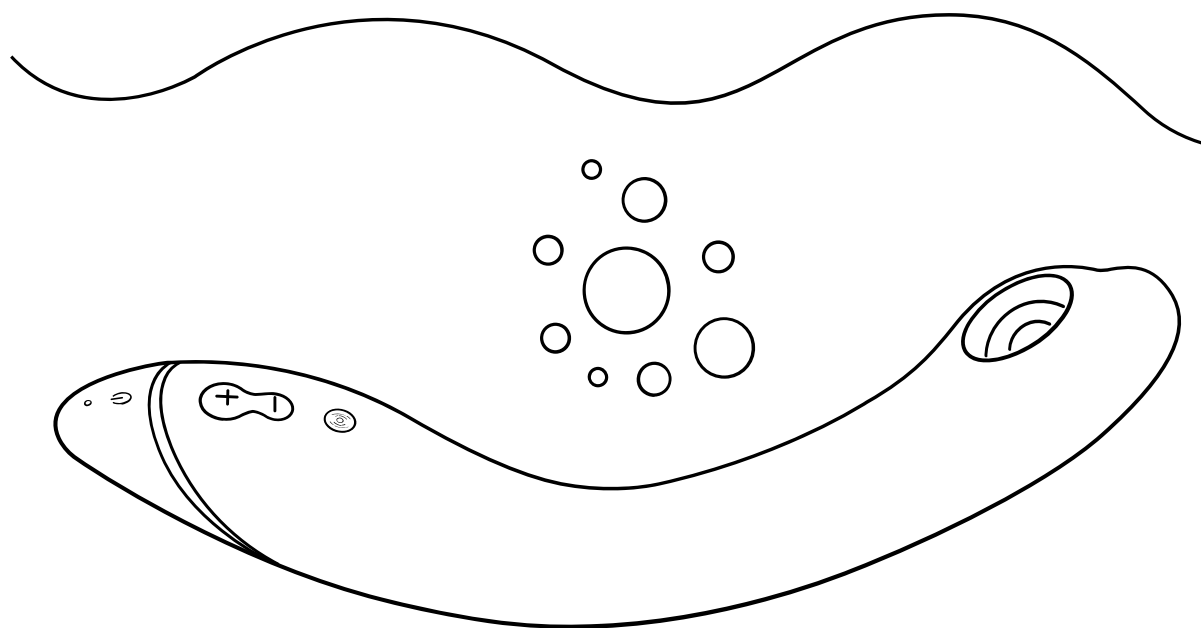

Uzklājiet rotaļlietu tīrīšanas šķidrumu.

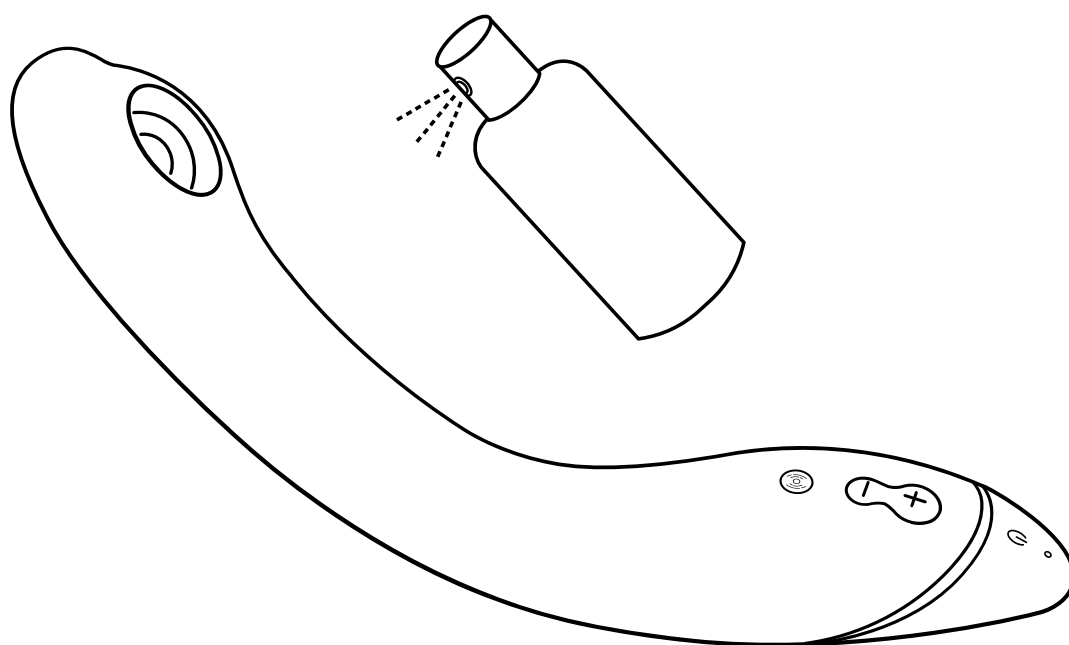

Uzmanīgi nožāvējiet un nespiediet membrānu.

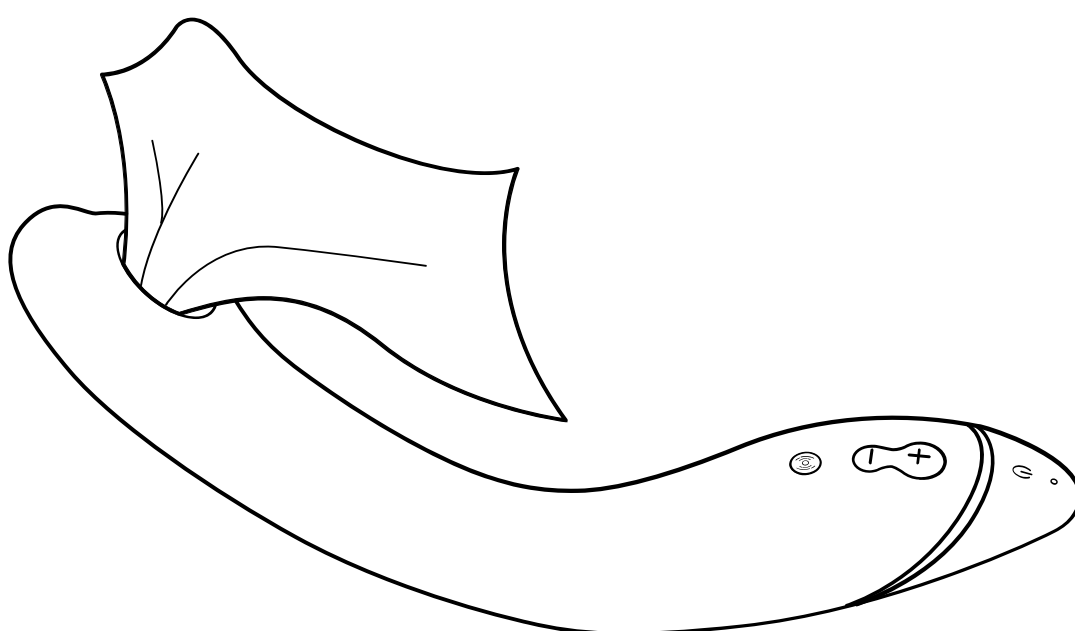

Ierīce ir ūdensizturīga  
(IPX7)

# UZLĀDE

Pirms pirmās lietošanas reizes uzlādējiet **OG**. Lai nodrošinātu ilgu kalpošanas laiku, atcerieties arī regulāri uzlādēt **OG**.

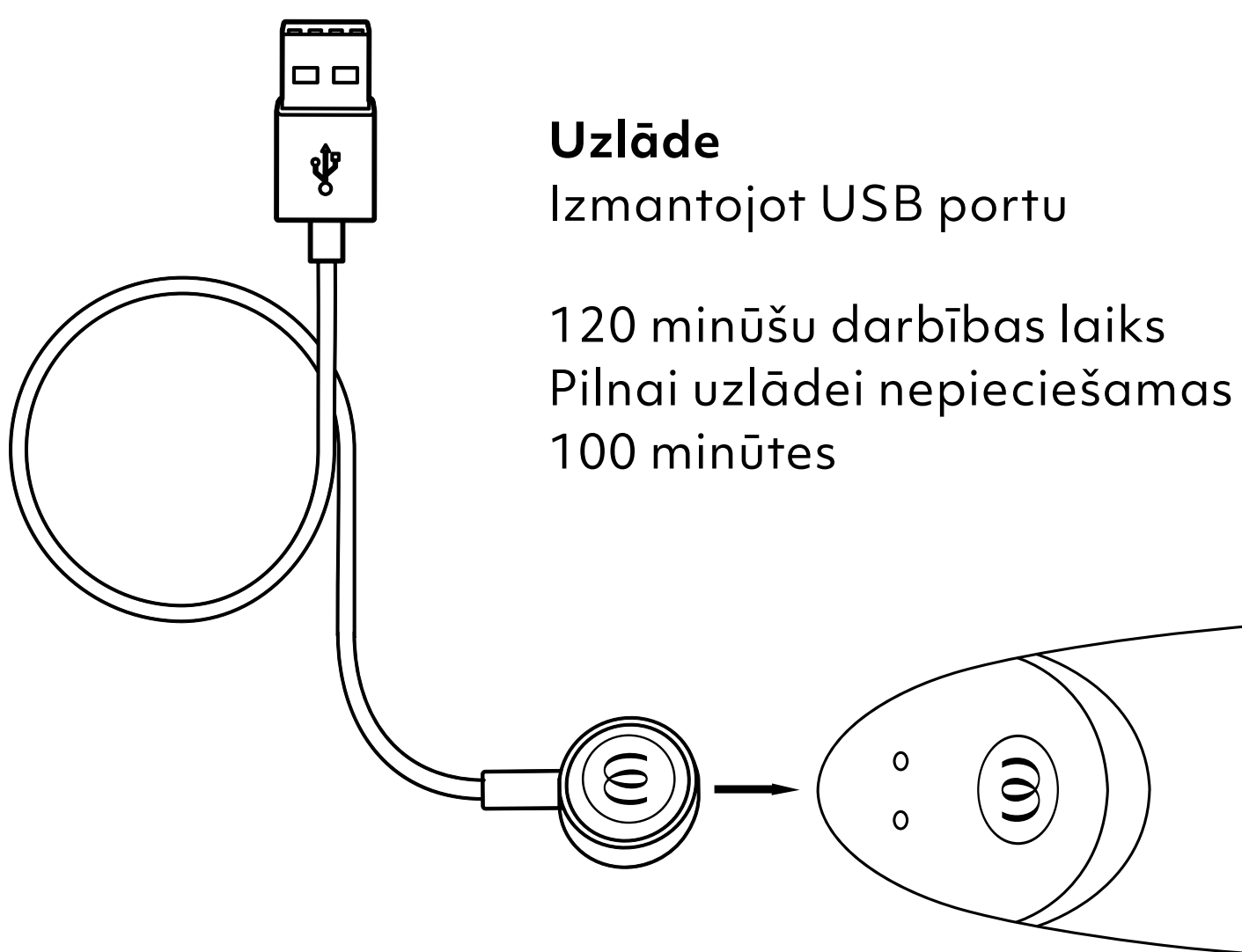

## Uzlāde

Izmantojot USB portu

120 minūšu darbības laiks  
Pilnai uzlādei nepieciešamas  
100 minūtes

---

## LED

Iesl./izsl./uzlāde

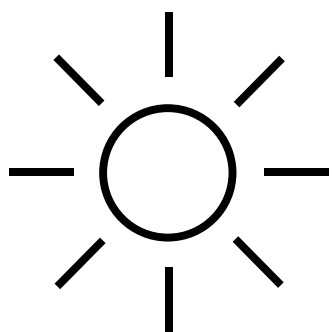

### Pilnībā uzlādēta

Nepārtraukti iedegas LED

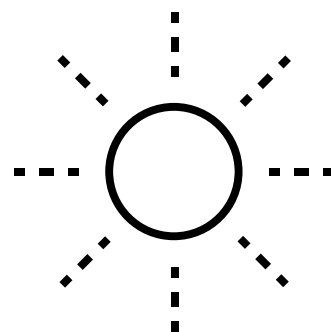

### Uzlāde

LED mirgo

# SAFETY INSTRUCTIONS

## BRĪDINĀJUMS!

Tiek pārdota tikai kā sajūtas stimulējoša ierīce. Izmantojiet ierīci tikai paredzētajam mērķim. Sargājiet ierīci no bērniem. Nav piemērota medicīniskiem mērķiem. Ja jūs atrodaties ārsta uzraudzībā un/vai jums ir kāds stāvoklis, kad nepieciešama kādas medicīniskas ierīces lietošana, pirms šīs ierīces lietošanas konsultējieties ar ārstu. Ja jums rodas ādas kairinājums, sāpes vai diskomforta sajūta, nekavējoties pārtrauciet ierīces lietošanu un konsultējieties ar ārstu.

Šo ierīci drīkst lietot tikai pieaugušie un personas ar samazinātām, sensorām vai garīgām spējām vai pieredzes un zināšanu trūkumu, ja tās tiek uzraudzītas vai instruētas saistībā ar ierīces lietošanu drošā veidā un apzinās saistītos riskus. Bērni nedrīkst rotaļāties ar ierīci. Bērni arī nedrīkst veikt ierīces tīrīšanu un apkopi. Nelietojiet ierīci uz zonām, kur āda ir pietūkusi vai iekaisusi.

- Pirms lietošanas noņemiet pīrsingus un rotaslietas dzimumorgānu apvidū.
- Pirms un pēc lietošanas vienmēr notīriet ierīci atbilstoši lietošanas instrukcijā sniegtajiem norādījumiem. Iesakām izmantot ierīci kopā ar lubrikantu uz ūdens bāzes.
- Lai izvairītos no ierīces bojājumiem, ierīci un tās bateriju nedrīkst pakļaut temperatūrai, kas ir augstāka par 45 °C, tos nedrīkst demontēt vai mehāniski vai elektriski bojāt.
- Kopīgi lietojot seksa rotaļlietas, var tikt pārnēsātas seksuāli transmisīvās slimības. Lietojiet seksa rotaļlietas tikai ar savu partneri. Nepieciešamības gadījumā izmantojiet ar partneri aizsarglīdzekļus. Nelietojiet rotaļlietu, ja pamanāt uz tās virsmas plaisas vai bojājumu pazīmes.
- Šī ierīce nav izstrādāta anālai lietošanai. Neizmantojiet to anāli!
- Lai izvairītos no traipiem, nenovietojiet ierīces mīksto pusi uz absorbējošas virsmas.
- Regulāri pārbaudiet, vai uzlādes ierīcei un pamatierīcei nav bojājumu, un nelietojiet ierīci, ja ir bojāti kādi komponenti.
- Magnētiskie lauki var ietekmēt mehāniskos un elektroniskos komponentus, piemēram, elektrokardiostimulatorus. Nelietojiet ierīci tieši virs elektrokardiostimulatora. Lai iegūtu vairāk informācijas, sazinieties ar savu ārstu. Nenovietojiet ierīces tuvumā kartes ar magnētiskām svītrām (piemēram, kredītkartes), jo tās var sabojāt ierīces magnētus.
- Ja ierīces darbībā pamanāt kādas novirzes no normas, izslēdziet to un skatiet atbalsta sadaļu, kas ir pieejama mūsu internetvietnē.

## UZLĀDE

- Pirms uzlādes ierīces pirmās lietošanas reizes pārbaudiet vietējā sprieguma līmeni, jo tas nedrīkst pārsniegt uz uzlādes ierīces norādīto maksimālo tīkla sprieguma līmeni.
- Drošības nolūkā ierīcei drīkst pievadīt tikai īpaši zemu spriegumu, kas atbilst uz ierīces norādītajam spriegumam.
- Nelietojiet un netīriet ierīci, kamēr baterija tiek uzlādēta.
- Nekad neiegremdējiet uzlādes ierīci vai uzlādes vadu ūdenī vai citā šķidrumā.
- Ierīcē ir baterijas, kas nav nomaināmi.
- Ierīcei ir uzlādējama litija jonu baterija.
- Pēc katra uzlādes procesa atvienojiet uzlādes vadu no elektroapgādes.

## LAI NODROŠINĀTU OPTIMĀLU IERĪCES LIETOŠANU, IEVĒROJIET ŠĀDUS NORĀDĪJUMUS:

- Lai garantētu ilgu baterijas lietošanas laiku, regulāri uzlādējiet ierīci, pat ja tā netiek lietota.
- Uzglabājiet drošā, sausā vietā, kas nav pakļauta tiešu saules staru iedarbībai.
- Lai izvairītos no bojājumiem, nelietojiet lubrikantus, gelus un masāžas eļļas uz silikona vai spirta bāzes, un kuru ražošanā ir izmantotas smaržvielas.

# GENERAL INFORMATION

## ELECTRICAL RATING

**Model:** OG

**Model No.:** TES10A

**Power Input:**

3,7 V=0,62 A: Built-in Li-Polymer rechargeable battery.

5 V=0,5 A: When charged using USB.

Use USB AC adaptor (not included) with power output corresponding to product rating. Use original provided cable only."

## CONTENT OF DELIVERY

Womanizer OG G-Spot vibrator, USB charging cable (AC adapter not included), cotton storage pouch, quick start guide, safety instructions

## ENVIRONMENTAL PROTECTION

As a distributor of electronic devices, we are legally obliged to accept the return of waste electrical and electronic devices free of charge. We expressly state that you as the user are legally obliged to return used batteries.

Never throw away electronic devices or batteries in the household waste. The symbol shown below (crossed-out wheeled bin) is intended to expressly remind you of this.

## MANUFACTURED AND DISTRIBUTED BY

**WOW Tech Europe GmbH**

Hermann-Blankenstein-Strasse 5

10249 Berlin

[www.wowtech.com](http://www.wowtech.com)

WOW Tech Europe GmbH reserves the right to make technical changes and changes to the design that serve to improve the device.

For information regarding patents see [womanizer.com/patents](http://womanizer.com/patents).

## CUSTOMER CARE

[care@womanizer.com](mailto:care@womanizer.com)

[womanizer.com](http://womanizer.com)

Designed in Germany. Made in China.

Date of issue: 10/2022.



# STILL WANT MORE?

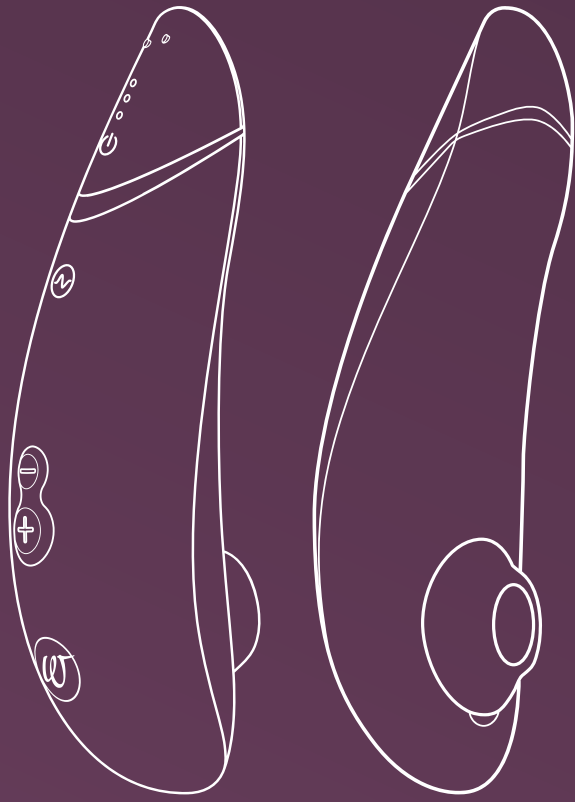

Pleasure Air  
Technology

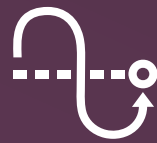

Autopilot



Smart Silence

**Premium 2**  
Define your luxury

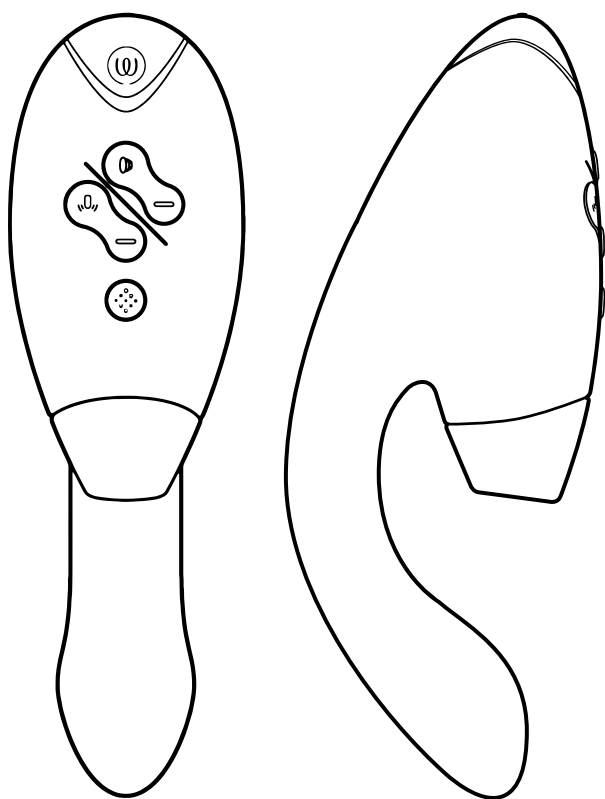

Pleasure Air  
Technology



Double Stimulation



Smart Silence

**DUO 2**  
Indulge in whole-body orgasms



#IMASTURBATE

# Hi!

Ви благодариме што го избравте **WOMANIZER**

Добредојдовте во свет полн со сензуални искуства кои ќе ви го збогатат животот. Избирајќи **WOMANIZER**, вие си гарантирате не само неспоредливи оргазми, туку и сосема нова желба за задоволство.

Уживајте во вашиот **WOMANIZER** – оргазми еден по друг.

Ајде, сакај се себе си!



ОПИС

НАЧИН НА КОРИСТЕЊЕ

УМНА ТИШИНА

ЧИСТЕЊЕ

ПОЛНЕЊЕ

SAFETY INSTRUCTIONS

ОПШТА ИНФОРМАЦИЈА

Please read the safety instructions in the  
Compliance & Safety Information before first use.



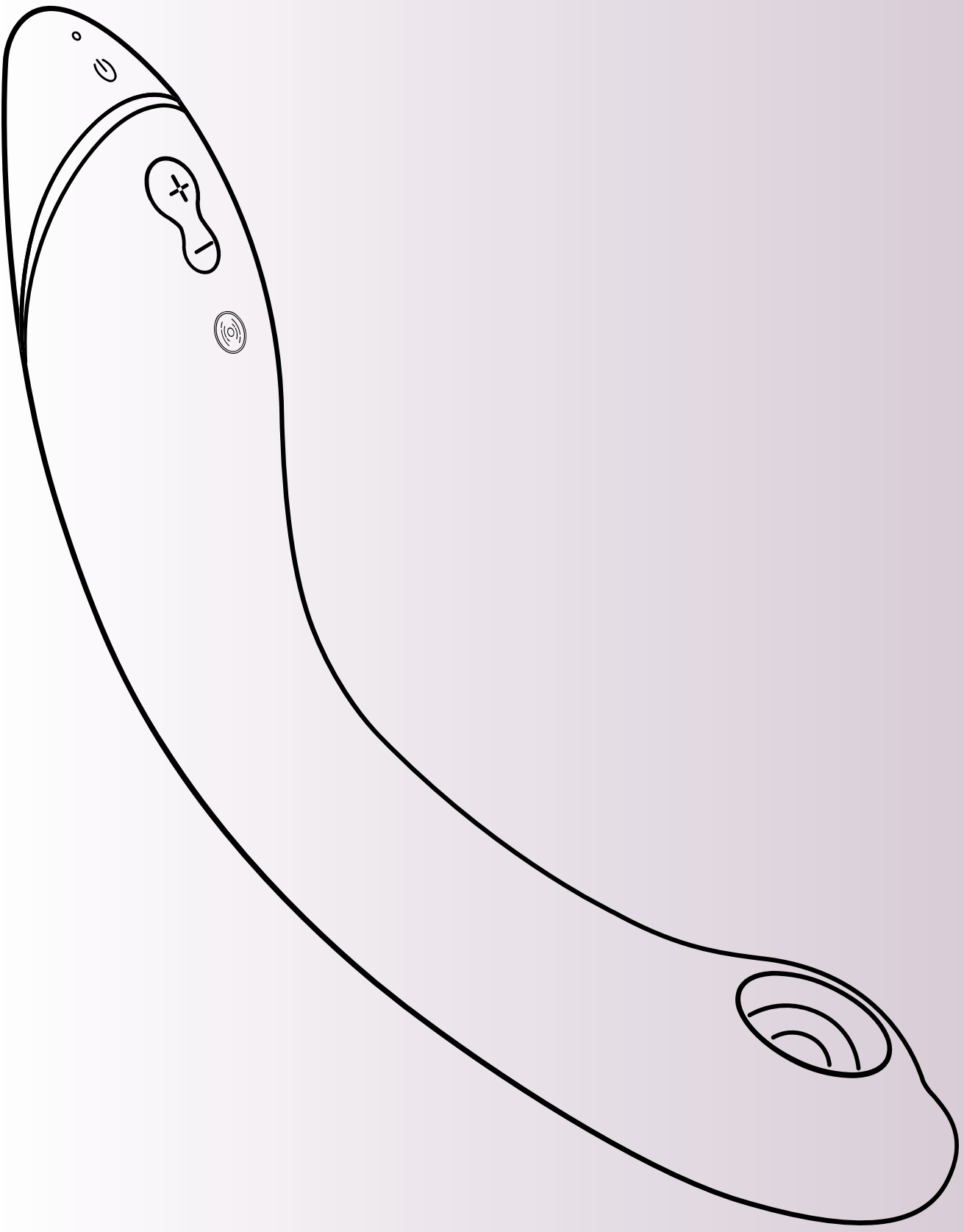

# ОПИС

**LED екран**  
Вклучено/Полнење

**Вклучување/  
Исклучување на  
умна тишина**  
Притиснете за 2  
секунди

**Вибрација**  
Кратко  
притиснете за да  
го активирате  
и зголемите  
интензитетот  
(3 нивоа)

**Pleasure Air Technology**  
(12 нивоа на интензитет)

**Вклучување/  
Исклучување**  
Притиснете за 2 секунди

**Зголемување на  
интензитетот**  
Кратко притиснете (+)

**Намалување на  
интензитетот**  
Кратко притиснете (-)

**Пријатна возбуда**  
Притиснете (-) за 1  
секунда

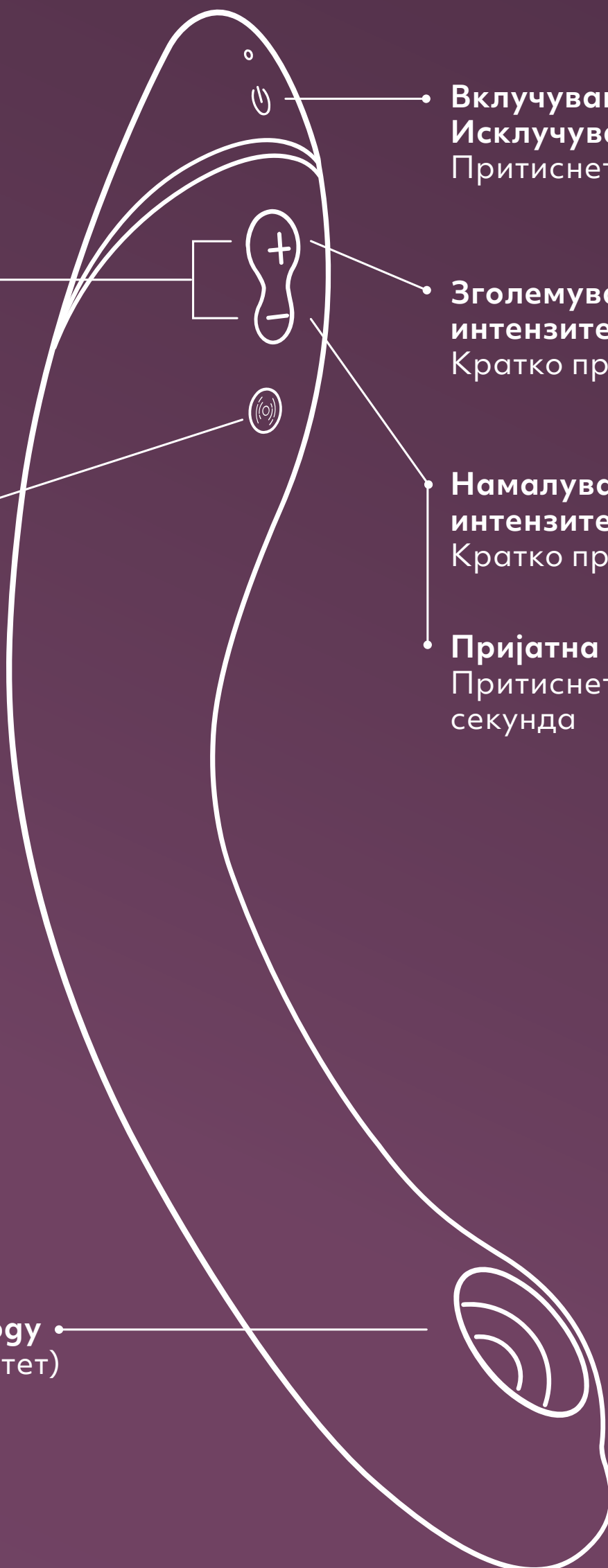

# НАЧИН НА КОРИСТЕЊЕ

## 1. Вклучување

Притиснете за 2 секунди LED сијаличката ќе покаже дека производот е вклучен.

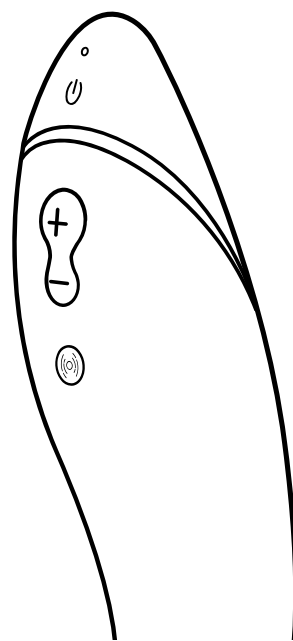

## 2. Употреба

За да се расположите, користете **OG** прво на вашиот клитор.

Додајте лубрикант базиран на вода во телото на **OG**.

Откако ќе се загреете, ставете го **OG** и истражувајте ја вашата Г точка!

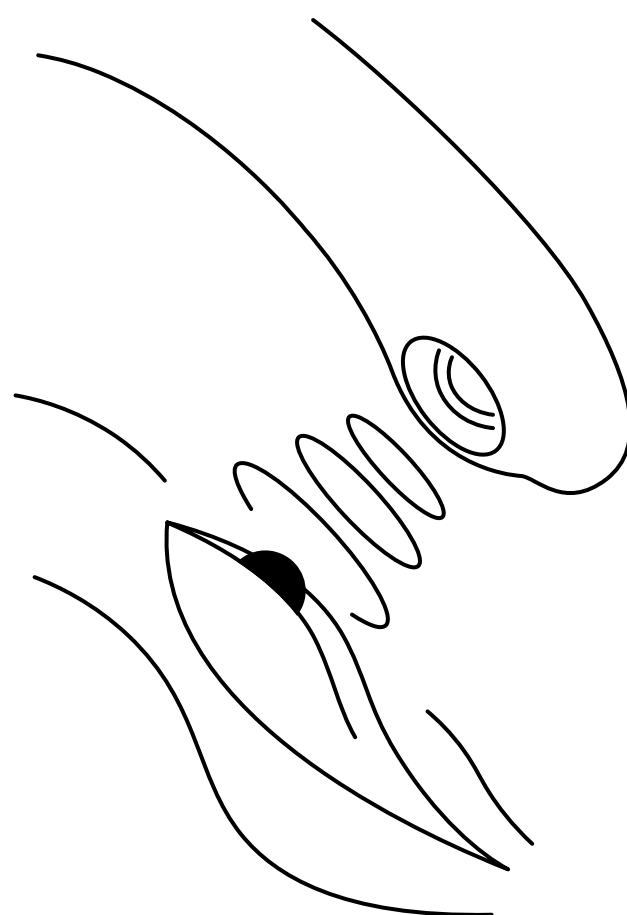

# НАЧИН НА КОРИСТЕЊЕ

## 3. Промена на интензитетот

**Зголемување** —  
Притиснете кратко  
**12 нивоа на интензитет**

**Зголемување** —  
Притиснете кратко  
**3 нивоа на вибрација**

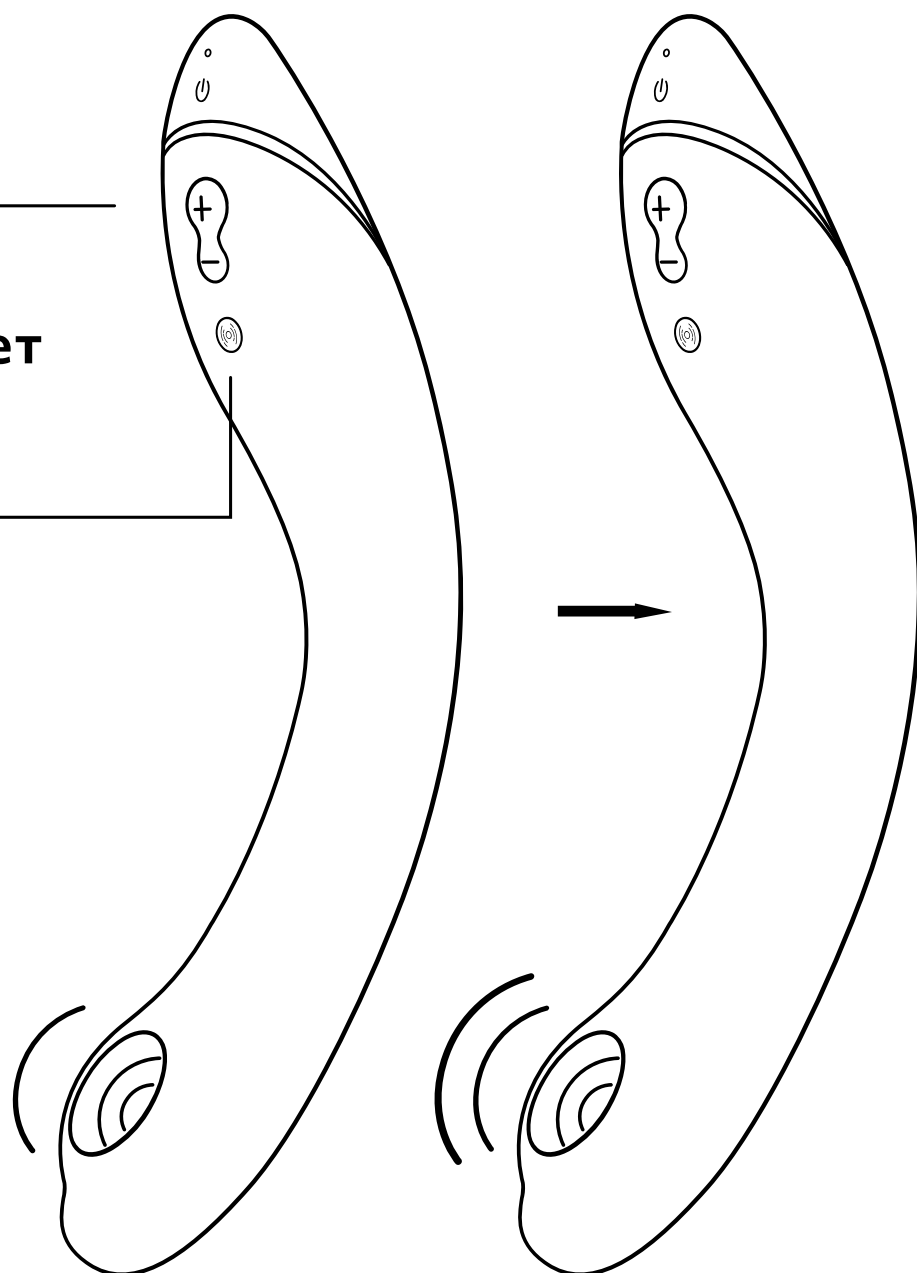

**Намалување** —  
Притиснете кратко

**Пријатна возбуда**  
Притиснете (-)  
за 1 секунда, за  
да се вратите на  
интензитетот од ниво 1

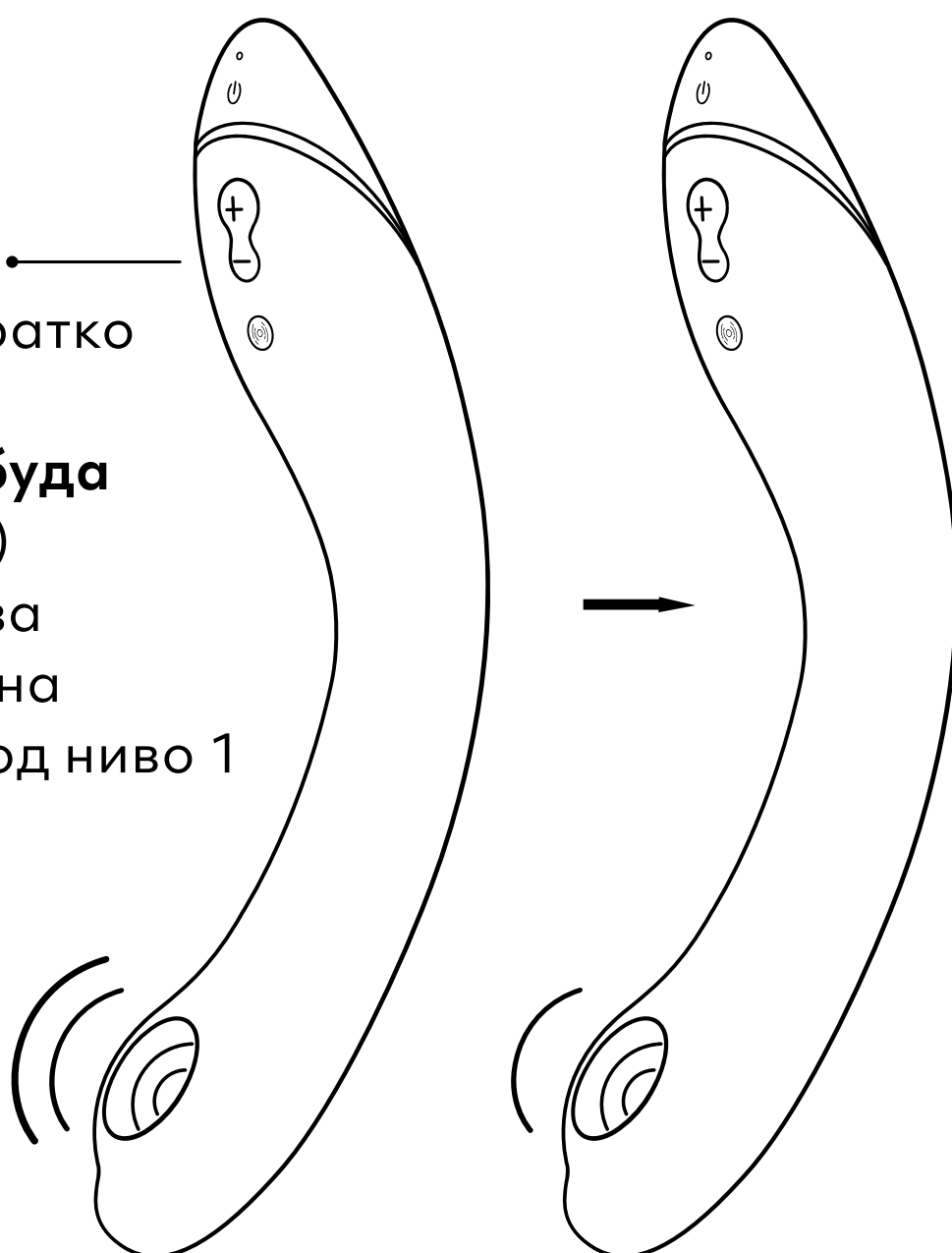

# НАЧИН НА КОРИСТЕЊЕ

## 4. Исклучување

Притиснете за 2 секунди

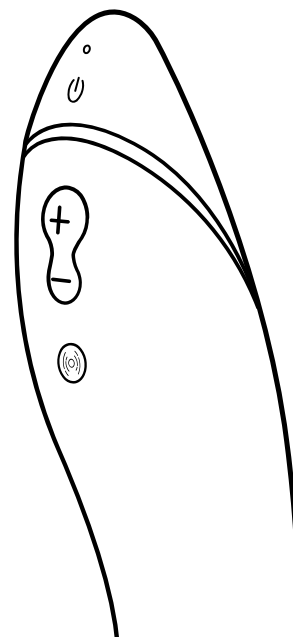

## УМНА ТИШИНА

**OG** се вклучува при допир со вашата кожа. Умната тишина ќе биде вклучена по подразбирање. Притиснете ги и задржете ги копчињата плус и минус за 2 секунди, за да вклучите или исклучите Умна тишина.

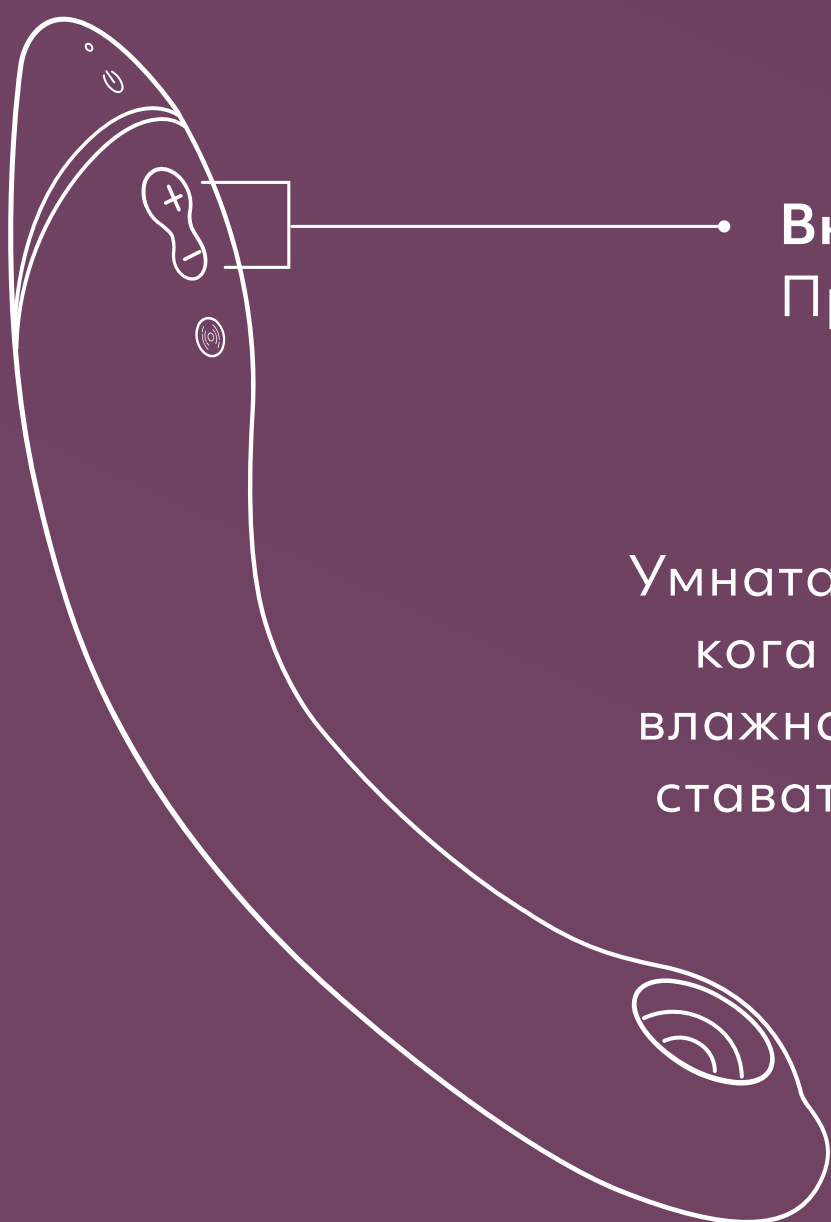

**Вклучување/Исклучување**  
Притиснете за 2 секунди

Умната тишина може да не работи кога главата за стимулација е влажна. Затоа погрижете се да не ставате лубрикант во главата на Pleasure Air.

# ЧИСТЕЊЕ

Измијте под вода.

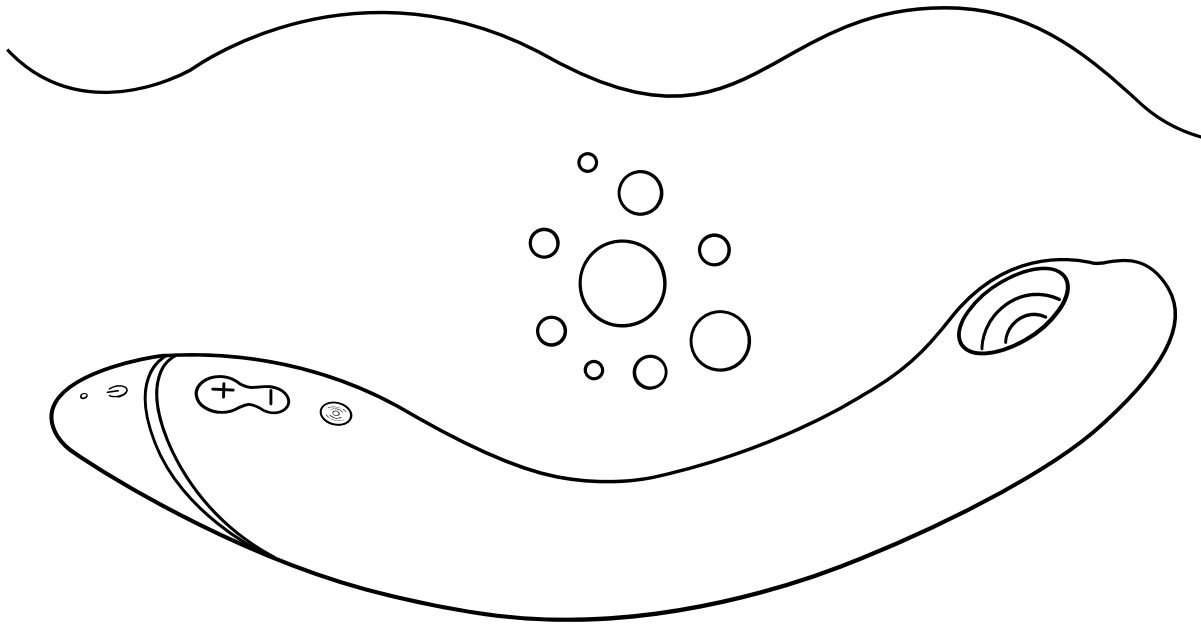

Нанесете средство за чистење на играчки.

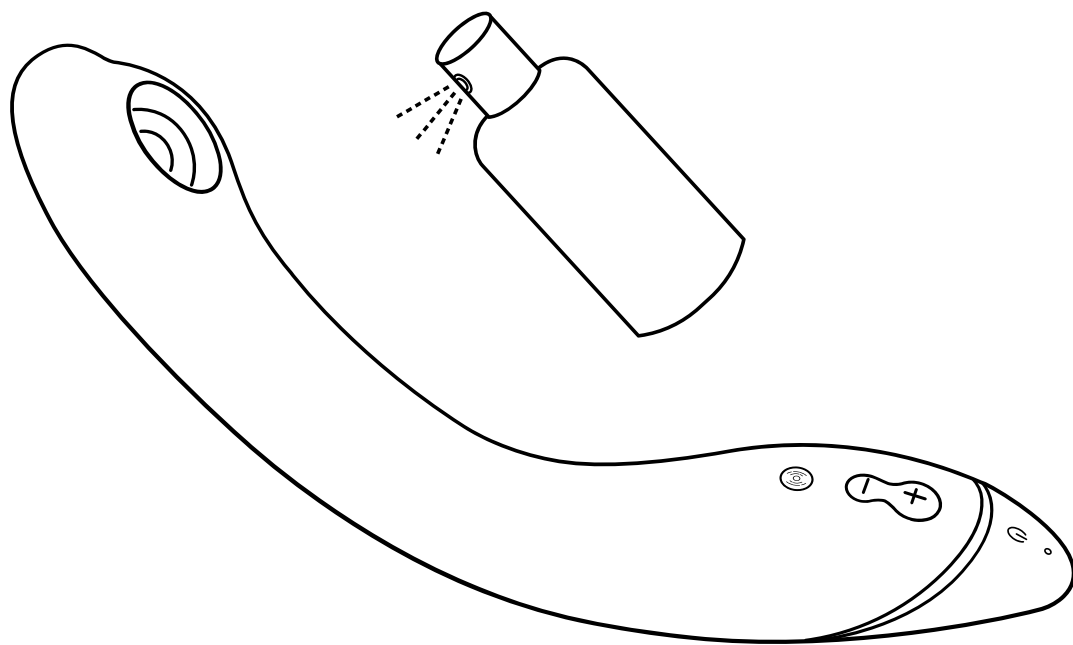

Исушете го внимателно, без премногу да ја притискате мембраната.

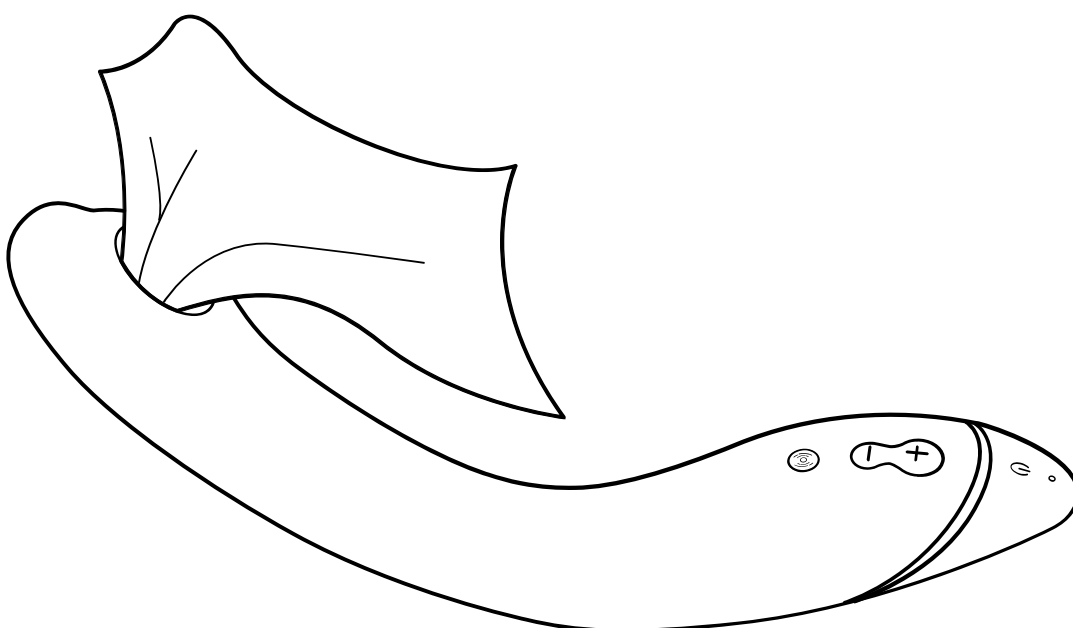

Водоотпорен (IPX7)

# ПОЛНЕЊЕ

Наполнете го вашиот **OG** пред првата употреба. Исто така, не заборавате да го полните вашиот **OG** редовно, за да обезбедите долг век на батеријата.

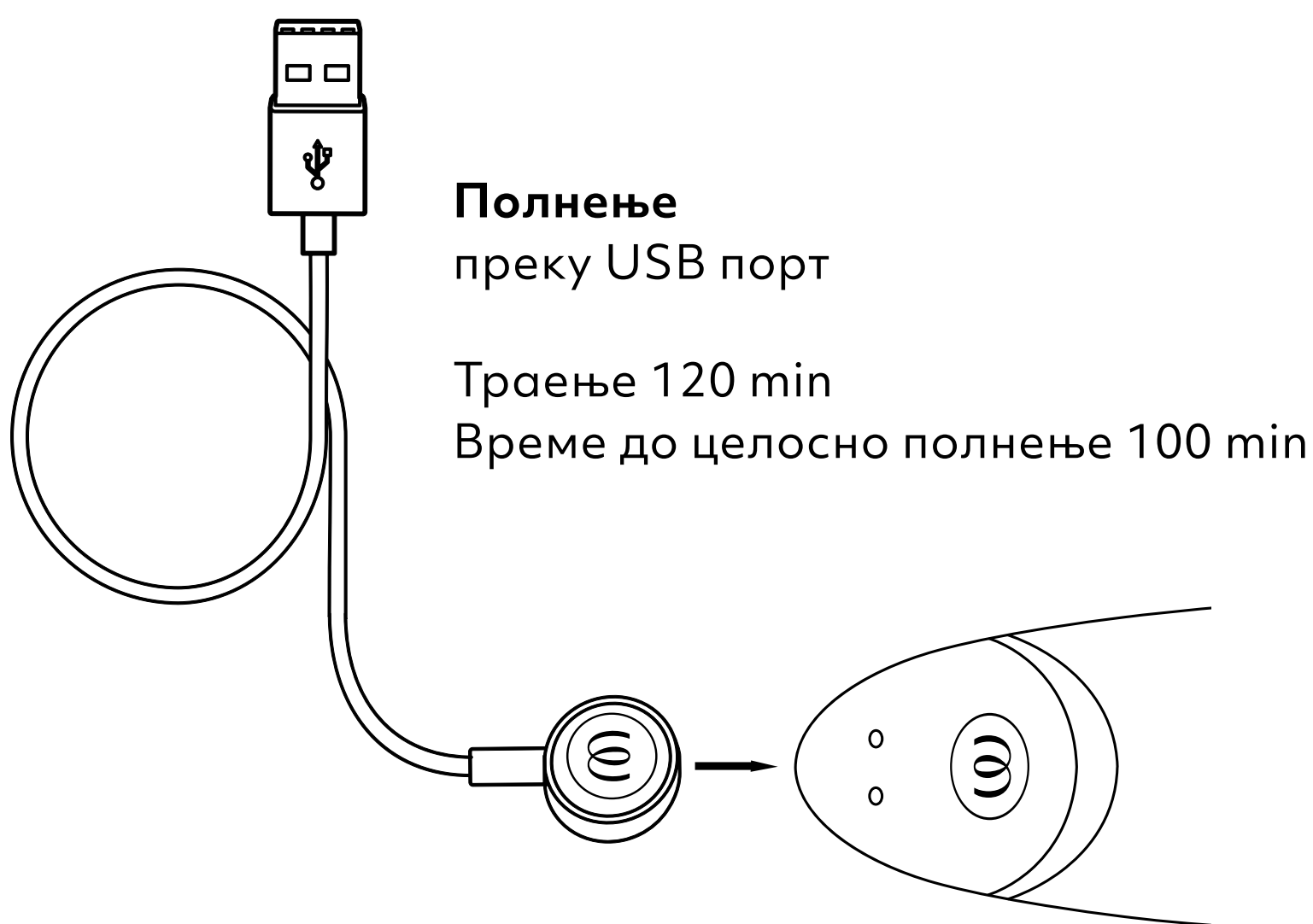

## Полнење

преку USB порт

Траење 120 min

Време до целосно полнење 100 min

---

## LED

Вклучено/Исклучено/полнење

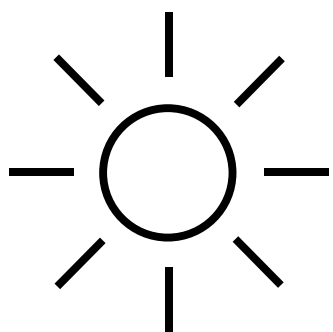

**Целосно наполнето**  
LED сијаличките светат  
постојано

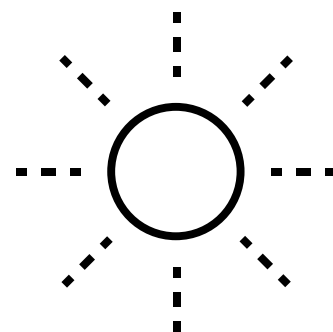

**Полнење**  
LED сијаличките трепкаат

# SAFETY INSTRUCTIONS

## ПРЕДУПРЕДУВАЊЕ

Се продава само како производ за широка потрошувачка. Помагалото треба да се користи само за намената што му е определена. Чувајте го производот подалеку од деца. Не е соодветен за медицински цели. Ако сте под лекарски надзор и/или имате заболување што бара употреба на медицинско помагало, ве молиме посветувајте се со својот лекар пред да го користите производот. Ако почувствувате иритација на кожата, болка или непријатност, веднаш престанете да го користите производот и консултирајте се со својот лекар.

Ова помагало може да го користат само возрасни лица и лица со намалени физички, сетилни или ментални способности, недоволно искусни или обучени лица, доколку се под надзор или им се дадат инструкции за користење на уредот на безбеден начин и им се објаснат можните опасности поврзани со користењето на помагалото. Децата не смеат да си играат со помагалото. Децата не смеат да го чистат и да го одржуваат помагалото. Да не се користи на отечени или воспалени делови од кожата.

- Отстранете ги пирсинзите и накитот во пределот на гениталиите пред употреба.
- Секогаш чистете го производот пред и по употреба според инструкциите во упатството за употреба.
- За да се избегне оштетување на производот, не смее да се изложуваат производот и батеријата на температура повисока од 45°C, да се расклопуваат или да се оштетува нивната механика или електрика.
- Користењето на исти секс-играчки заедно со други лица може да доведе до сексуално преносливи заболувања. Немојте да ги користите секс-играчките со други корисници освен со партнерот. Ако е потребно, почитувајте ги заштитните мерки со партнерот. Не користете ја играчката ако забележите пукнатини или знаци на уништување на амбалажата.
- Производот не е наменет за анална употреба. Не користете го анално!
- Не поставувајте ја меката страна од производот на површина што впира за да избегнете појава на дамки.
- Редовно проверувајте дали полначот и играчката се оштетени и не го користете уредот ако е оштетен некој негов елемент.
- Магнетните полиња можат да влијаат на механичките и електронските компоненти, како што се пејсмејкерите. Не користете го уредот директно преку пејсмејкерот. За повеќе информации, контактирајте го вашиот лекар. Не носете картички со магнетни ленти (на пример, кредитни картички) во близина на уредот, бидејќи тие можат да бидат оштетени од магнетите на производот.
- Ако ви се чини дека играчката не функционира нормално, исклучете ја и обратете се за помош на одделот „Поддршка“ на нашата веб-локација.

## ПРЕДУПРЕДУВАЊЕ

- Пред првата употреба на уредот за полнење, проверете го нивото на локалниот напон, бидејќи напонот на локалната мрежа не смее да го надмине максималниот напон на мрежата обележан на уредот за полнење.
- Производот смее да се испорачува само со безбеден многу низок напон, што ќе одговара на ознаката што е поставена на него.
- Не користете или чистете го производот додека се полни батеријата.
- Никогаш не потопувајте го уредот за полнење или кабелот за полнење во вода или други течности.
- Ова помагало содржи батерии што не се заменуваат.
- Овој производ содржи литиум-јонска батерија што може да се полни.
- По секој процес на полнење, исклучете го кабелот за полнење од струјното коло.

## ВЕ МОЛИМЕ СЛЕДЕТЕ ГИ СЛЕДНИТЕ НАСОКИ ЗА ОПТИМАЛНА УПОТРЕБА НА ПРОИЗВОДОТ:

- Ве молиме полнете го уредот редовно, дури и ако не се користи, за да се обезбеди долг животен век на батеријата.
- Да се чува на безбедно, суво место без изложеност на директна сончева светлина.
- Препорачуваме да користите лубрикант врз основа на вода, заедно со вашиот производ. Не користете парфимирани, силиконски или алкохолни лубриканти, гелови и масла за масирање, за да избегнете оштетување на уредот.



# GENERAL INFORMATION

## ELECTRICAL RATING

**Model:** OG

**Model No.:** TES10A

**Power Input:**

3,7 V=0,62 A: Built-in Li-Polymer rechargeable battery.

5 V=0,5 A: When charged using USB.

Use USB AC adaptor (not included) with power output corresponding to product rating. Use original provided cable only."

## CONTENT OF DELIVERY

Womanizer OG G-Spot vibrator, USB charging cable (AC adapter not included), cotton storage pouch, quick start guide, safety instructions

## ENVIRONMENTAL PROTECTION

As a distributor of electronic devices, we are legally obliged to accept the return of waste electrical and electronic devices free of charge. We expressly state that you as the user are legally obliged to return used batteries.

Never throw away electronic devices or batteries in the household waste. The symbol shown below (crossed-out wheeled bin) is intended to expressly remind you of this.

## MANUFACTURED AND DISTRIBUTED BY

**WOW Tech Europe GmbH**

Hermann-Blankenstein-Strasse 5

10249 Berlin

[www.wowtech.com](http://www.wowtech.com)

WOW Tech Europe GmbH reserves the right to make technical changes and changes to the design that serve to improve the device.

For information regarding patents see [womanizer.com/patents](http://womanizer.com/patents).

## CUSTOMER CARE

[care@womanizer.com](mailto:care@womanizer.com)

[womanizer.com](http://womanizer.com)

Designed in Germany. Made in China.

Date of issue: 10/2022.



# STILL WANT MORE?

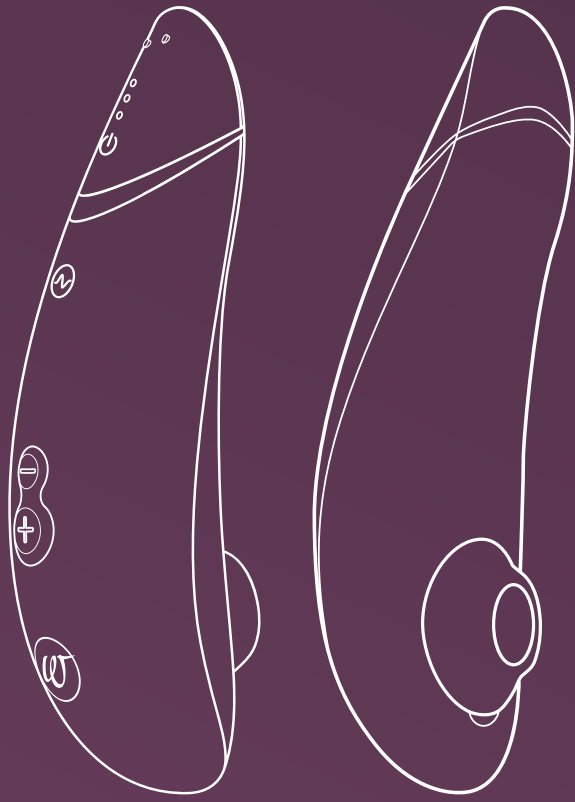

Pleasure Air  
Technology

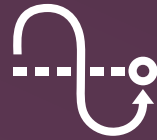

Autopilot



Smart Silence

**Premium 2**  
Define your luxury

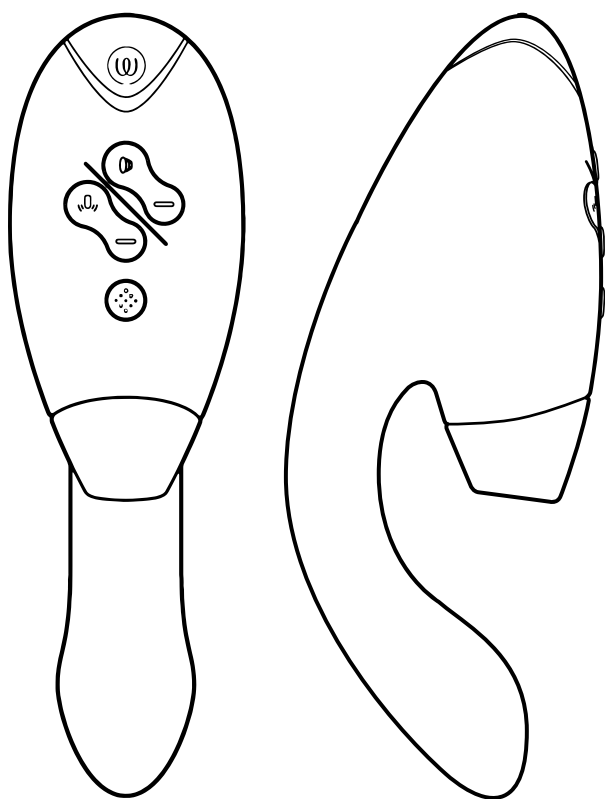

Pleasure Air  
Technology



Double Stimulation



Smart Silence

**Duo 2**  
Indulge in whole-body orgasms



#IMASTURBATE

# Hi!

Ďakujeme, že ste si vybrali **WOMANIZER**!

Vitajte vo svete zmyselných zážitkov, ktoré obohatia váš život. Výberom **WOMANIZER** vám zaručujeme nielen orgazmy, aké ste ešte nezažili, no aj úplne novú túžbu po slasti.

Užívajte si svoj **WOMANIZER** – s každým jedným orgazmom.

Tak do toho, opojte sa rozkošou!



**POPIS**

**NÁVOD NA POUŽITIE**

**FUNKCIA SMART SILENCE**

**ČISTENIE**

**NABÍJANIE**

**SAFETY INSTRUCTIONS**

**VŠEOBECNÉ INFORMÁCIE**

Please read the safety instructions in the  
Compliance & Safety Information before first use.

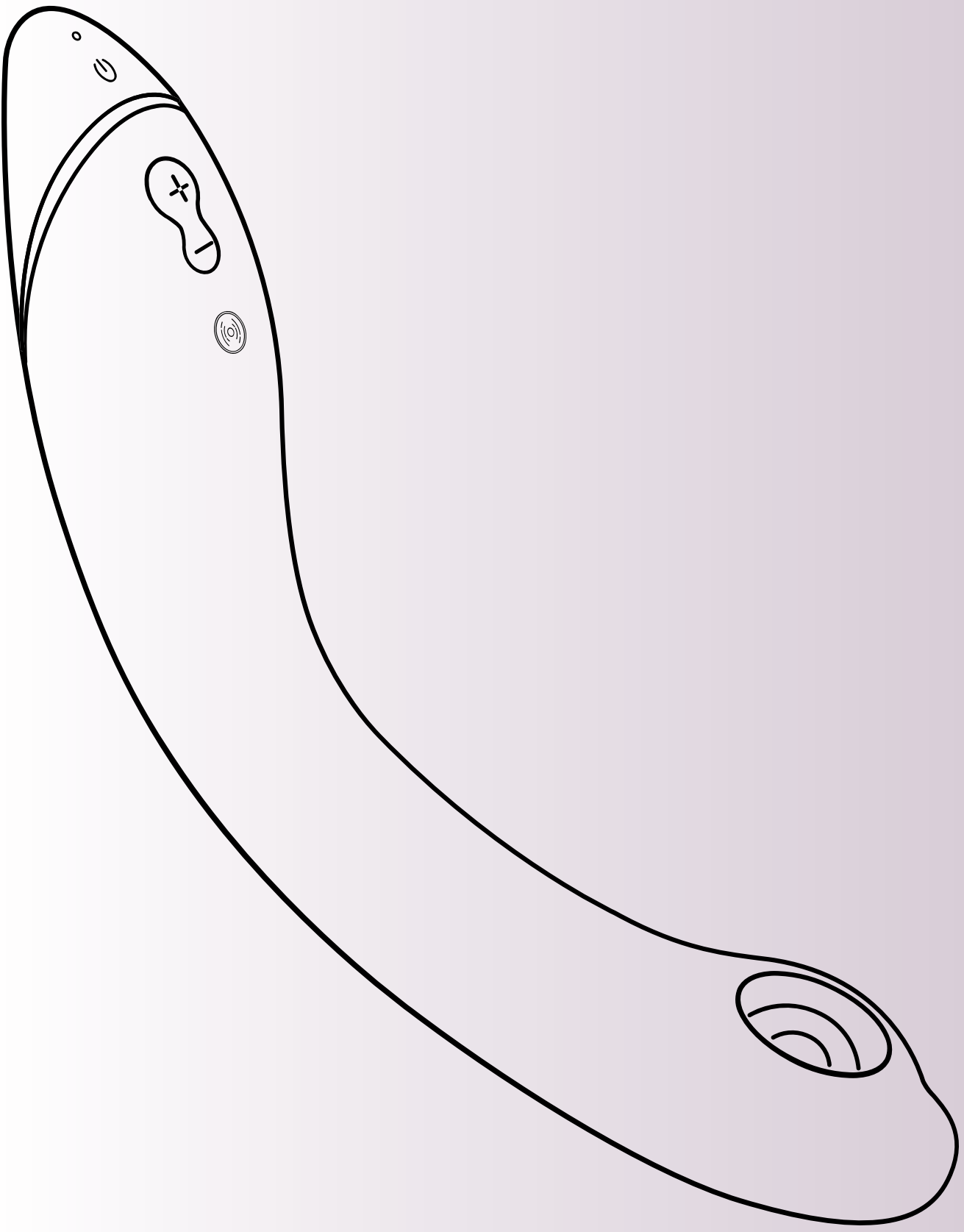

# POPIS

**LED displej**  
Zapnutie/nabíjanie

**Zapnutie/vypnutie ,  
funkcie  
Smart Silence**  
Stlačte a držte  
2 sekundy stlačené

**Vibrácie**  
Krátkym  
stlačením  
aktivujete a  
zvýšite intenzitu  
(3 úrovni)

**Pleasure Air Technology**  
(12 úrovni intenzity)

**Zapnutie/vypnutie**  
Stlačte a držte 2  
sekundy stlačené

**Zvýšenie intenzity**  
Krátko stlačte (+)

**Zníženie intenzity**  
Zníženie intenzity

**Dozvuky**  
Stlačte (-) a držte 1  
sekundu stlačené



# NÁVOD NA POUŽITIE

## 1. Zapnutie

Stlačte a držte  
2 sekundy stlačené  
Zapnutie výrobku bude  
signalizovať LED kontrolka.

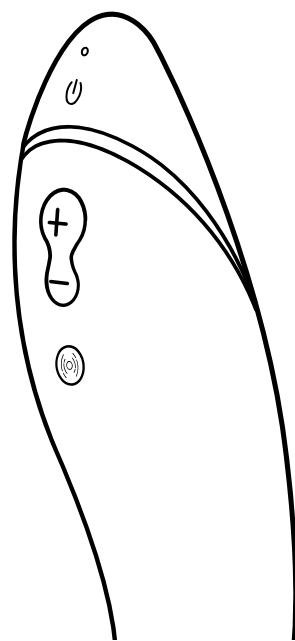

## 2. Používanie

Najprv **OG** použite  
na stimuláciu klitorisu, aby  
ste sa dostali do tej  
správnej nálady.

Na telo **OG** pridajte lubrikant  
na vodnej báze.

Po vytvorení nálady vložte  
**OG** dnu a preskúmajte svoj bod G!

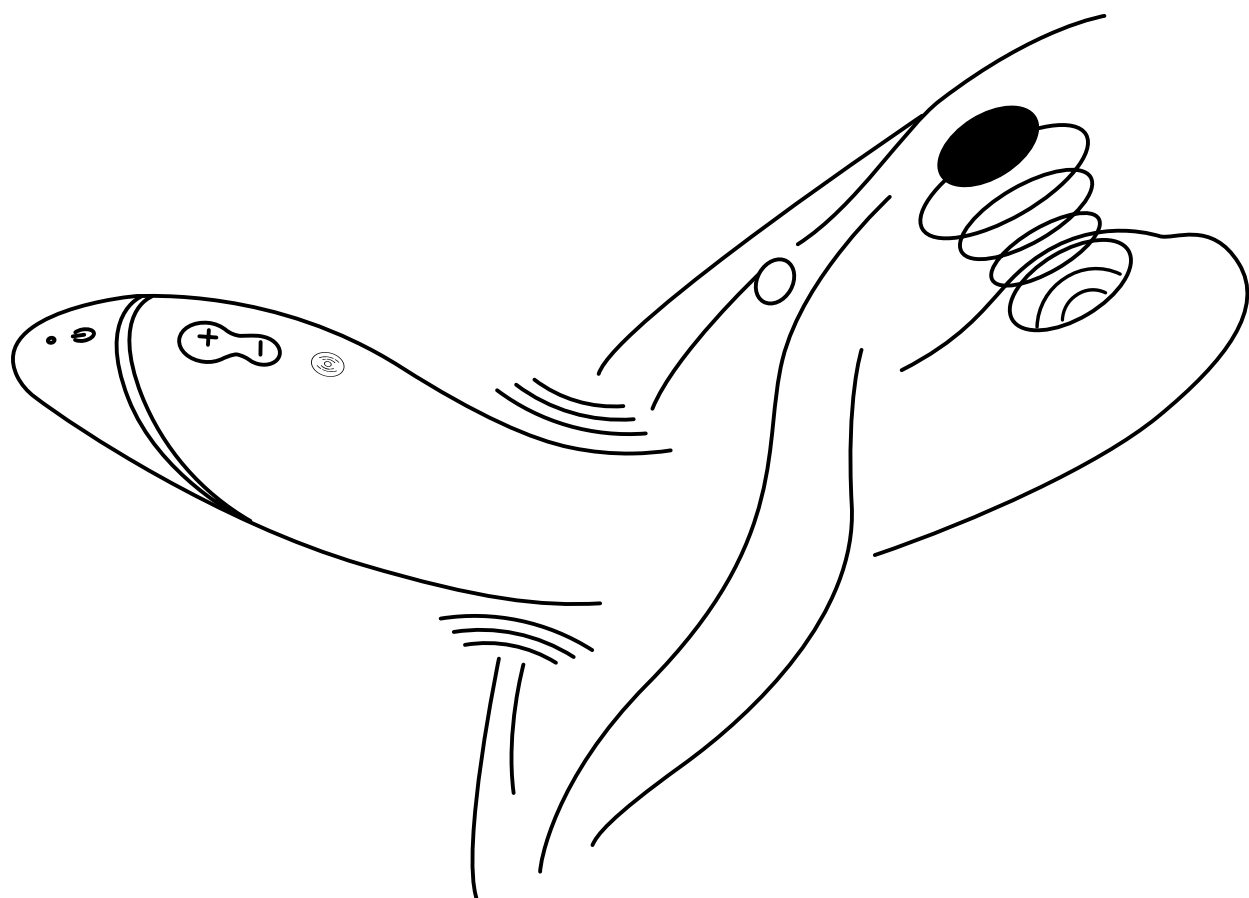
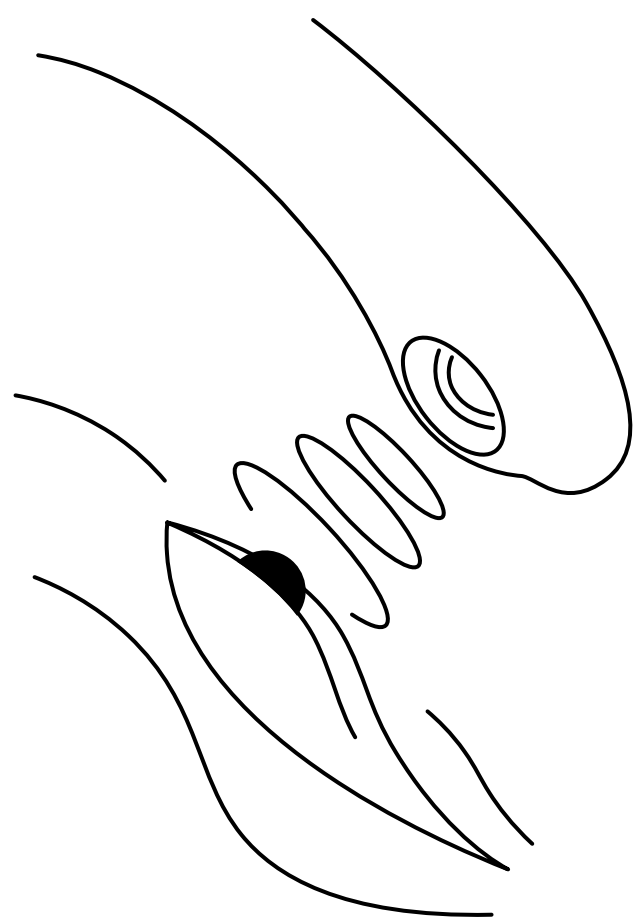



# NÁVOD NA POUŽITIE

## 3. Zmena intenzity

**Zvýšenie** •  
Krátke stlačenie  
**12 úrovni intenzity**

**Zvýšenie** •  
Krátke stlačenie  
**3 úrovne vibrácií**

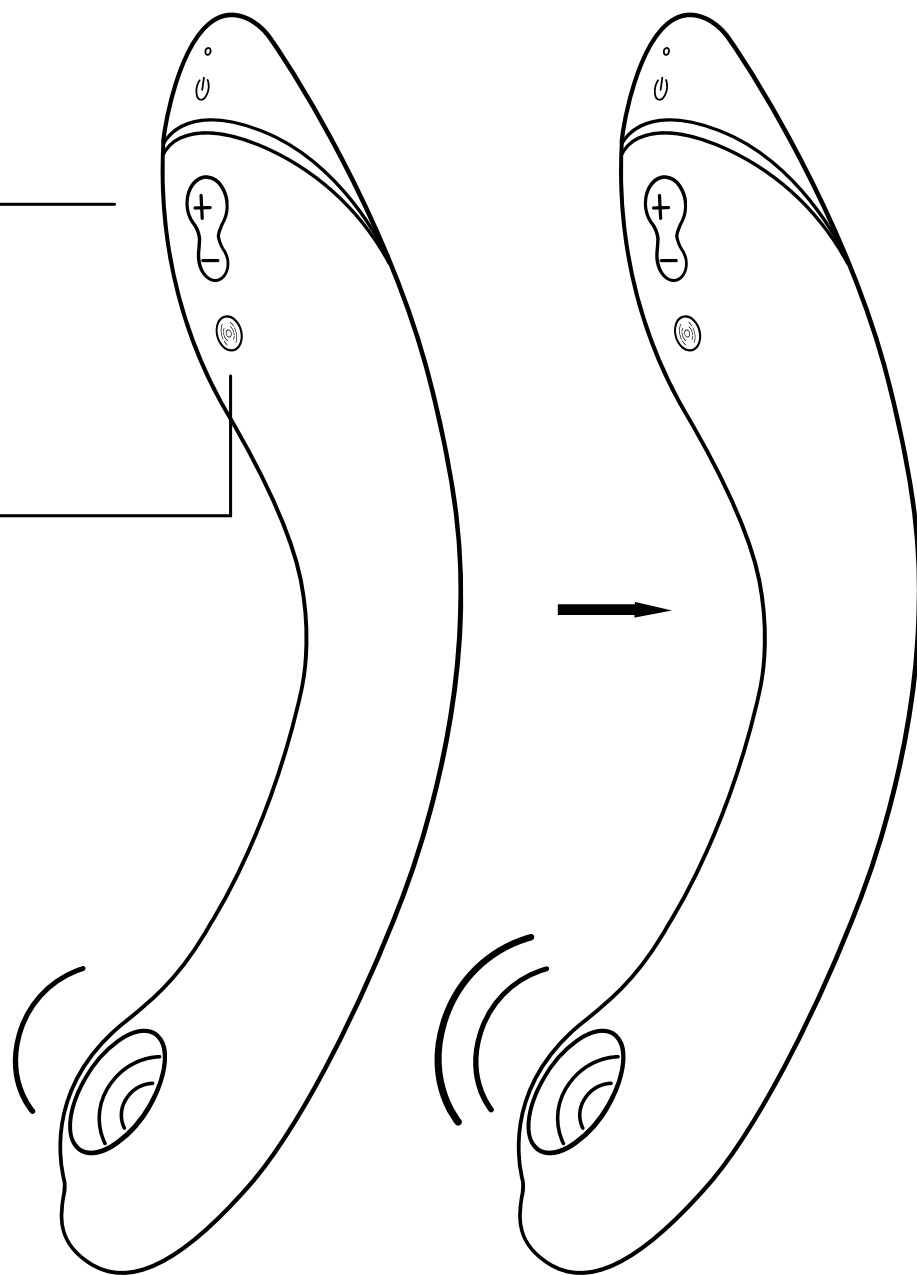

**Zníženie** •  
Krátke stlačenie

**Dozvuky**  
Stlačením (-) na 1  
sekundu sa vráťte na  
úroveň intenzity 1

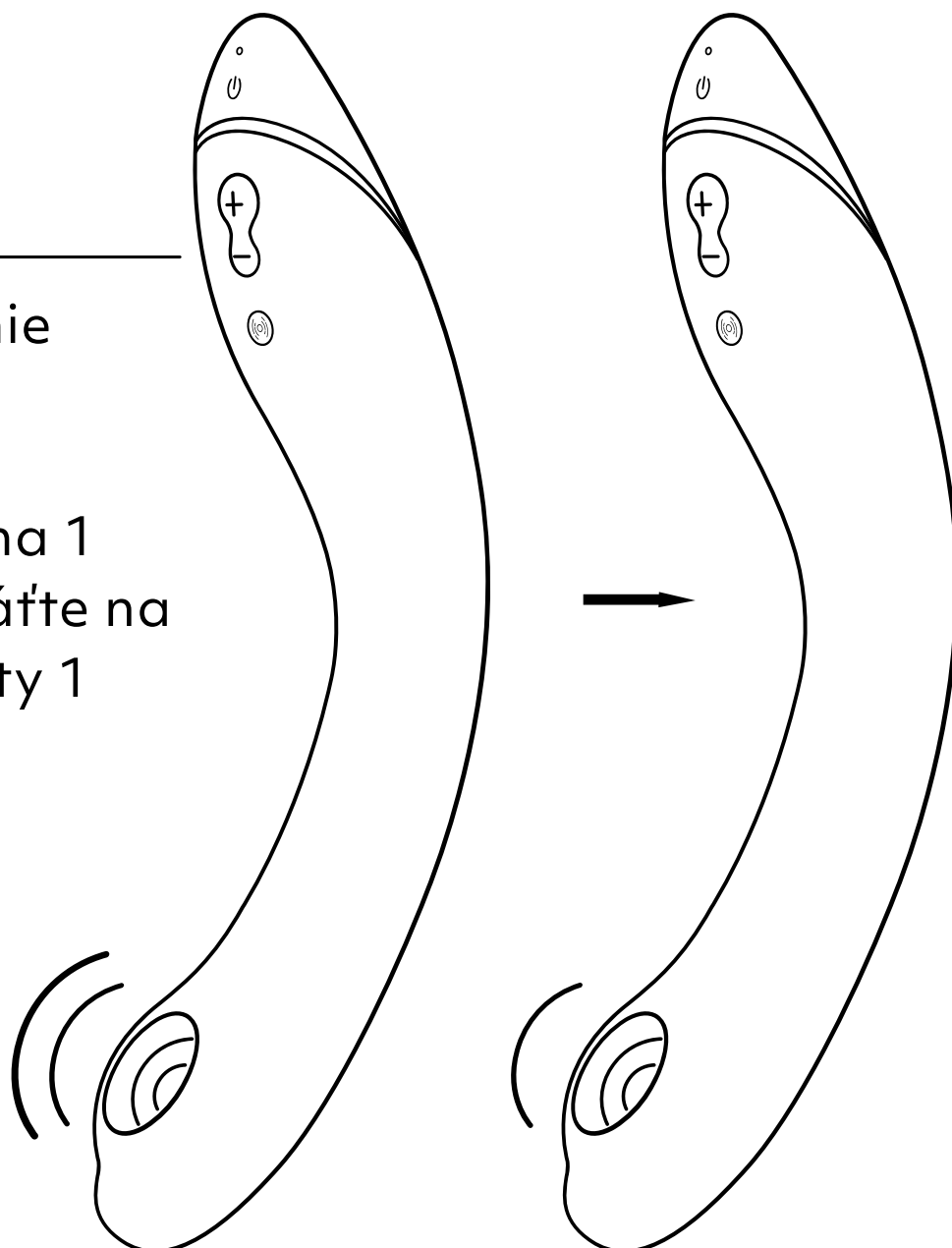

# NÁVOD NA POUŽITIE

## 4. Vypnutie

Stlačte a držte 2 sekundy stlačené

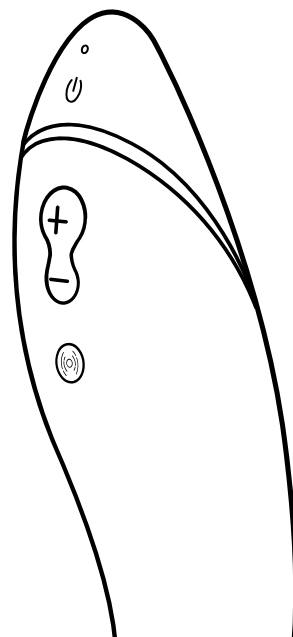

## FUNKCIA SMART SILENCE

**OG** sa zapne len vtedy, keď sa takmer dotýka vašej pokožky. Funkcia Smart Silence bude predvolene zapnutá. Stlačením a podržaním tlačidiel plus a mínus na 2 sekundy zapnete alebo vypnete funkciu Smart Silence.



**Smart Silence**  
**Zapnutie/vypnutie**  
Press Stlačte a držte 2 sekundy stlačené

Funkcia Smart Silence nemusí fungovať, ak je stimulačná hlavica vlhká. Uistite sa preto, že lubrikant nenanesiete do hlavice Pleasure Air.

# ČISTENIE

Čistite pod vodou.

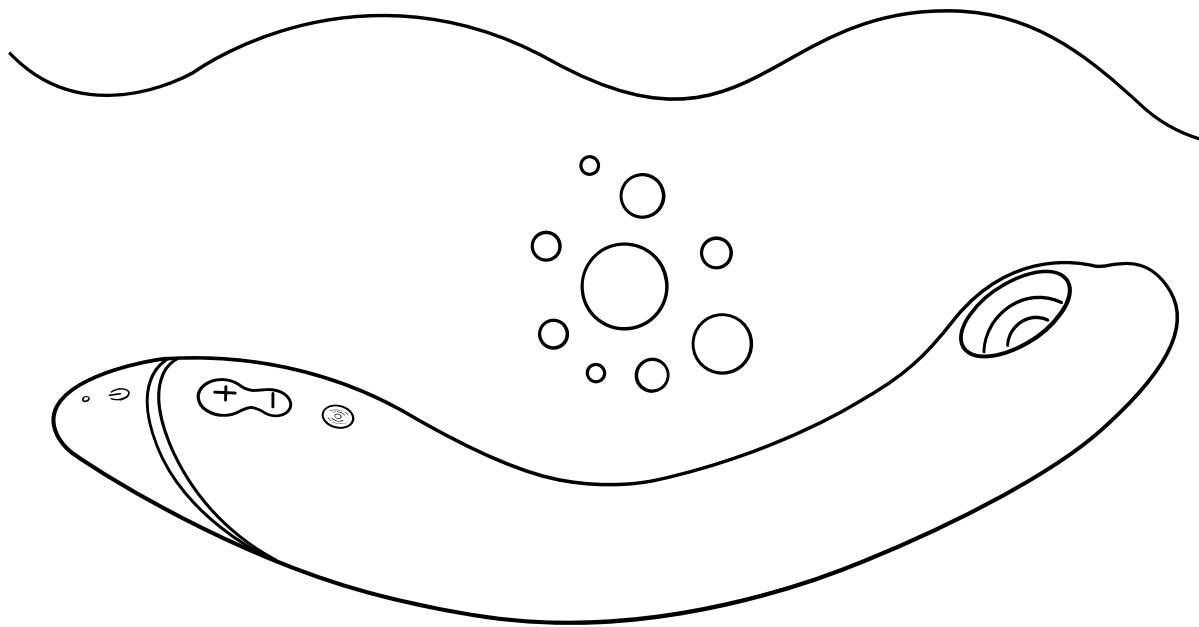

Použite čistiaci prostriedok na hračky.

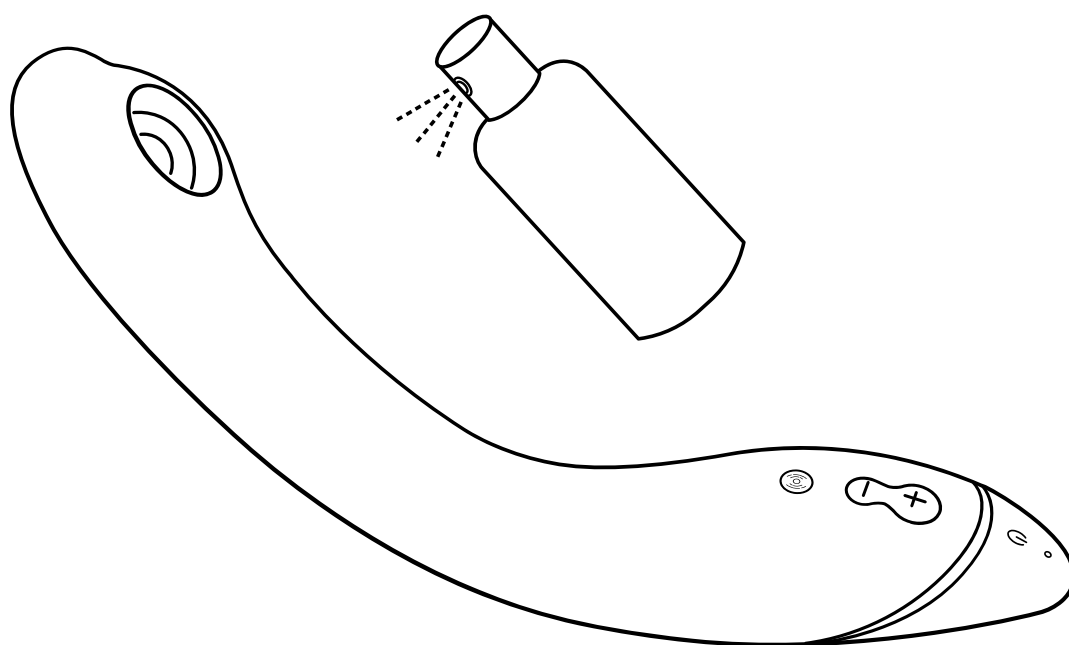

Dôkladne vysušte a dbajte, aby ste na membránu nevyvíjali príliš veľký tlak.

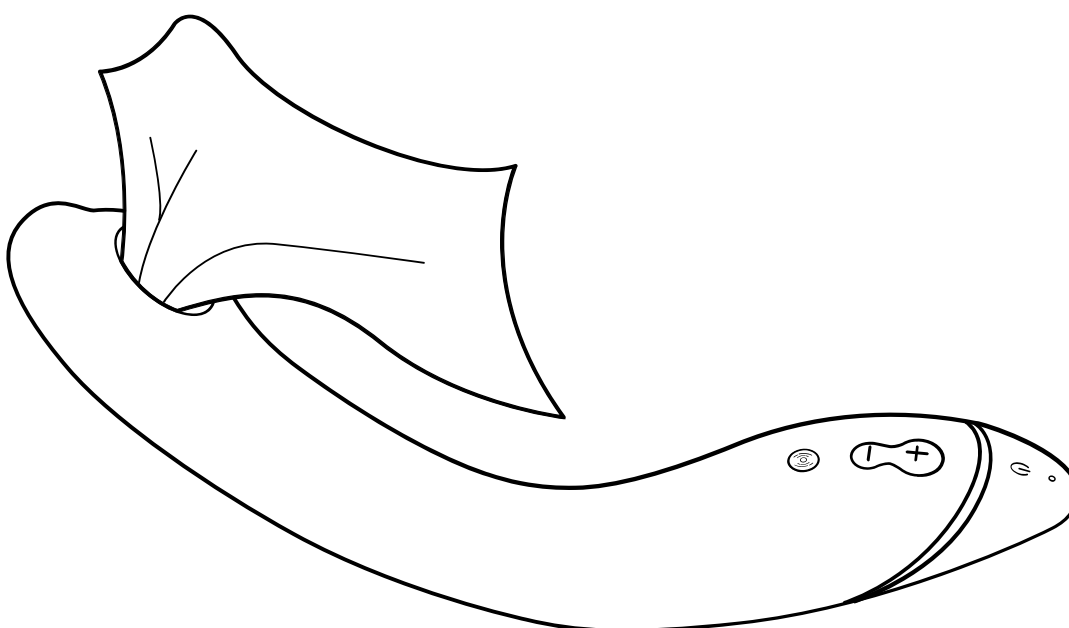

Vodotesnos  
(IPX7)

# NABÍJANIE

Pred prvým použitím **OG** nabite. Svoj **OG** tiež nezabúdajte pravidelne nabiť, aby ste zaistili dlhú životnosť batérie.

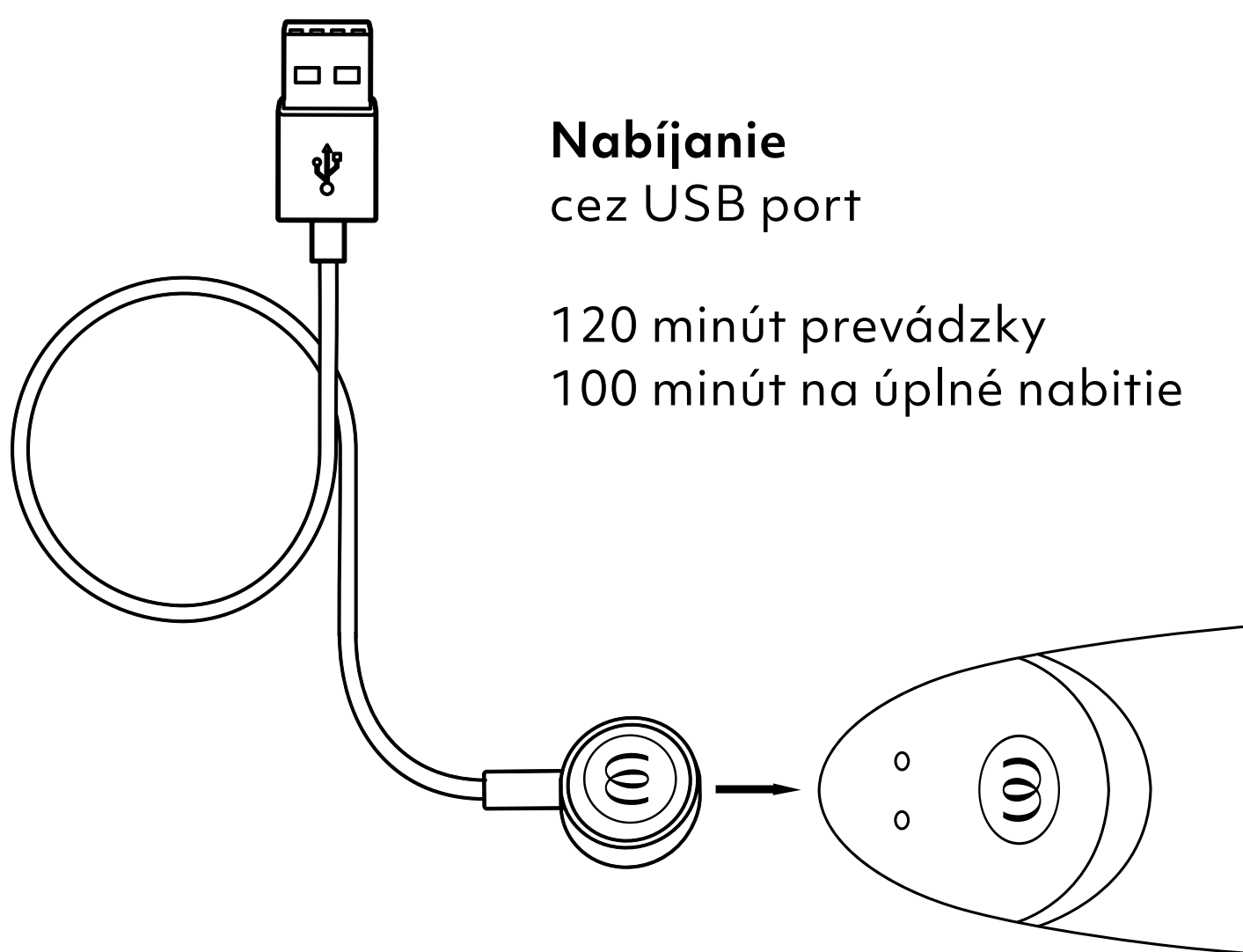

**Nabíjanie**  
cez USB port

120 minút prevádzky  
100 minút na úplné nabitie

---

## LED kontrolka

Zapnutie/vypnutie/nabíjanie

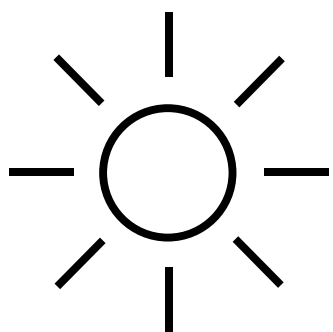

**Úplne nabité**  
LED kontrolka neustále svieti

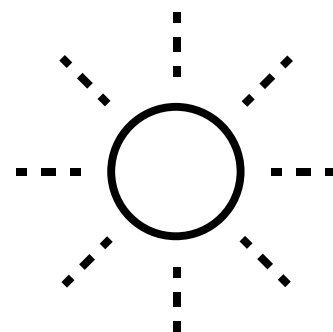

**Nabíjanie**  
LED kontrolka bliká

# SAFETY INSTRUCTIONS

## VAROVANIE

Predáva sa iba ako nový výrobok. Výrobok používajte iba na určený účel. Výrobok uchovávajte mimo dosahu detí. Nie je vhodný na zdravotnícke účely. Ak ste v starostlivosti lekára alebo máte stav vyžadujúci použitie akejkoľvek zdravotníckej pomôcky, pred použitím tohto výrobku sa poraďte so svojim lekárom. Ak sa u vás vyskytne akékoľvek podráždenie pokožky, bolesť alebo nepríjemný pocit, výrobok okamžite prestaňte používať a poraďte sa so svojim lekárom.

Tento výrobok môžu používať iba dospelí. Osoby so zníženými fyzickými, zmyslovými alebo mentálnymi schopnosťami, alebo s nedostatkom skúseností a znalostí môžu tento výrobok používať len pod dohľadom alebo ak dostali pokyny týkajúce sa bezpečného spôsobu použitia výrobku a porozumeli príslušným rizikám. Deti sa s výrobkom nesmú hrať. Deti nesmú vykonávať čistenie a údržbu výrobku. Nepoužívajte na opuchnuté alebo zapálené oblasti pokožky.

- Pred použitím odstráňte z oblasti genitálií piercingy a šperky.
- Pred použitím a po použití výrobok vždy očistite podľa pokynov uvedených v príručke.
- Výrobok a jeho batéria nesmú byť vystavené teplotám nad 45 °C, nesmú byť demontované alebo mechanicky či elektricky poškodené. Predídete tak poškodeniu výrobku.
- Spoločným používaním sexuálnych hračiek môže dôjsť k prenosu pohlavných chorôb. Sexuálne hračky nepoužívajte spoločne s nikým okrem svojho partnera. V prípade potreby používajte s partnerom ochranné prostriedky. Hračku nepoužívajte, ak zistíte na materiáli krytu akékoľvek praskliny alebo poškodenia.
- Tento výrobok nie je určený na análne použitie. Nepoužívajte análne!
- Výrobok nepoužívajte, ak je niektorý z komponentov poškodený.
- Nabíjačku a hračku pravidelne kontrolujte, či nie sú poškodené. Ak sú nejaké komponenty poškodené, prestaňte výrobok používať.
- Magnetické polia môžu ovplyvňovať mechanické a elektronické komponenty, napríklad kardiostimulátory. Výrobok nepoužívajte priamo cez kardiostimulátor. Ďalšie informácie získate od svojho lekára. Kartu s magnetickými prúžkami (napr. kreditné karty) neprenášajte do blízkosti zariadenia, pretože by sa mohli poškodiť magnetmi na výrobku.
- Ak sa zdá, že hračka nefunguje správne, vypnite ju a prečítajte si časť podpory na našej webovej stránke.

## NABÍJANIE

- Pred prvým použitím nabíjačky skontrolujte úroveň miestneho napätia, pretože napätie v miestnej sieti nesmie prekročiť maximálne sieťové napätie uvedené na nabíjačke.
- Výrobok sa môže napájať iba pri bezpečnom mimoriadne nízkom napätí, ktoré zodpovedá označeniu na výrobku.
- Pokiaľ sa batéria nabíja, výrobok nepoužívajte ani nečistite.
- Nabíjačku ani nabíjací kábel nikdy neponárajte do vody alebo iných kvapalín.
- Tento výrobok obsahuje batérie, ktoré nie sú vymeniteľné.
- Tento výrobok obsahuje nabíjateľnú lítium-iónovú batériu.
- Po každom procese nabíjania vťahnite nabíjací kábel zo siete.

## NA OPTIMÁLNE POUŽITIE VÝROBKU POSTUPOJTE PODĽA NASLEDUJÚCICH POKYNOV:

- Ak chcete zabezpečiť dlhú životnosť batérie, zariadenie pravidelne nabíjajte, aj keď sa nepoužíva.
- Skladujte na bezpečnom a suchom mieste bez priameho pôsobenia slnečného žiarenia.
- S hračkou odporúčame používať lubrikant na vodnej báze. Nepoužívajte parfumované lubrikačné gély, lubrikačné gély ani masážne oleje na báze silikónu alebo alkoholu. Predídete tak poškodeniu výrobku.

# GENERAL INFORMATION

## ELECTRICAL RATING

**Model:** OG

**Model No.:** TES10A

**Power Input:**

3,7 V=0,62 A: Built-in Li-Polymer rechargeable battery.

5 V=0,5 A: When charged using USB.

Use USB AC adaptor (not included) with power output corresponding to product rating. Use original provided cable only."

## CONTENT OF DELIVERY

Womanizer OG G-Spot vibrator, USB charging cable (AC adapter not included), cotton storage pouch, quick start guide, safety instructions

## ENVIRONMENTAL PROTECTION

As a distributor of electronic devices, we are legally obliged to accept the return of waste electrical and electronic devices free of charge. We expressly state that you as the user are legally obliged to return used batteries.

Never throw away electronic devices or batteries in the household waste. The symbol shown below (crossed-out wheeled bin) is intended to expressly remind you of this.

## MANUFACTURED AND DISTRIBUTED BY

**WOW Tech Europe GmbH**

Hermann-Blankenstein-Strasse 5

10249 Berlin

[www.wowtech.com](http://www.wowtech.com)

WOW Tech Europe GmbH reserves the right to make technical changes and changes to the design that serve to improve the device.

For information regarding patents see [womanizer.com/patents](http://womanizer.com/patents).

## CUSTOMER CARE

[care@womanizer.com](mailto:care@womanizer.com)

[womanizer.com](http://womanizer.com)

Designed in Germany. Made in China.

Date of issue: 10/2022.



# STILL WANT MORE?



Pleasure Air  
Technology

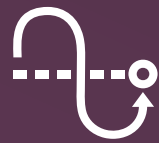

Autopilot



Smart Silence

**Premium 2**  
Define your luxury

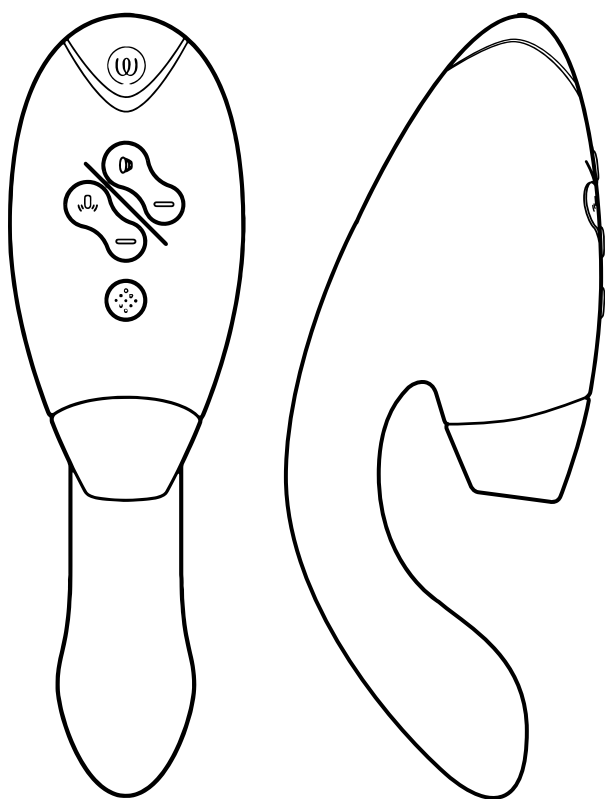

Pleasure Air  
Technology



Double Stimulation



Smart Silence

**DUO 2**  
Indulge in whole-body orgasms



#IMASTURBATE



# Hi!

**WOMANIZER'**ı tercih ettiğiniz için teşekkür ederiz!

Hayatınızı renklendirecek duyusal deneyimlerle dolu bir dünyaya hoş geldiniz. **WOMANIZER'**ı seçerek, yalnızca kıyaslanamayacak kadar büyük orgazmları değil, aynı zamanda tamamen yeni bir zevk arzusunu da garantilemiş olursunuz.

**WOMANIZER'**la peşpeşe gelen orgazmların tadını çıkar.

Şimdi, kendini sevme zamanı!



TANIM

NASIL KULLANILIR

AKILLI SESSİZLİK

TEMİZLEME

ŞARJ

SAFETY INSTRUCTIONS

GENEL BİLGİLER

Please read the safety instructions in the  
Compliance & Safety Information before first use.

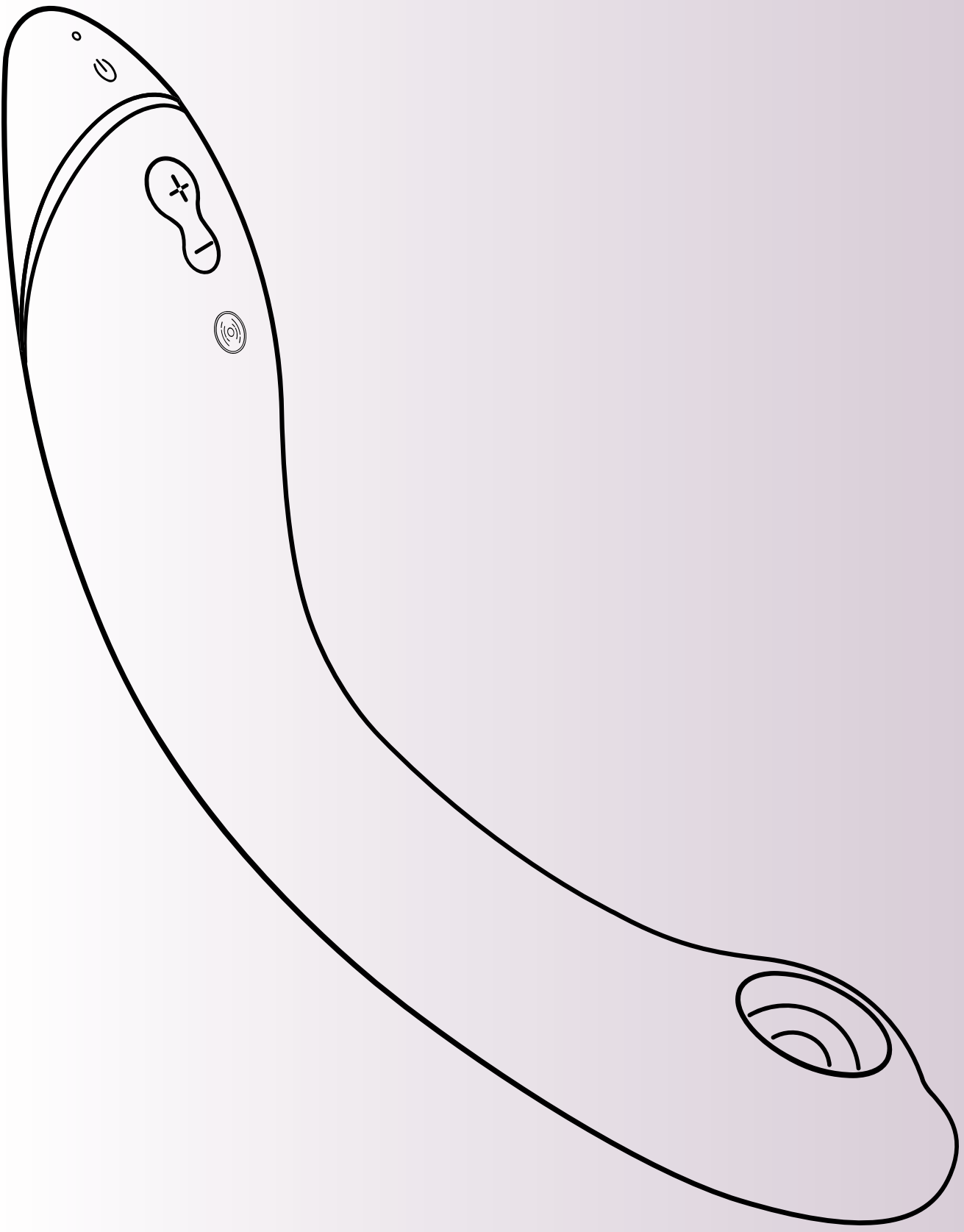

# TANIM

**LED Ekran**  
Açık/Şarj oluyor

**Akıllı Sessizlik**  
**Açık/Kapalı**  
2 saniye boyunca basın

**Titreşim**  
Etkinleştirmek ve yoğunluğu artırmak için kısaca basın (3 seviye)

**Pleasure Air Technology**  
(12 Yoğunluk Seviyesi)

**Açık/Kapalı**  
2 saniye boyunca basın sekundy stlačení

**Yoğunluğu Artırma**  
(+) düğmesine kısa süre basın

**Yoğunluğu Azaltma**  
(-) düğmesine kısa süre basın

**Hoş bir deneyim sonrası bir süre daha hissedilen haz**  
1 saniye boyunca (-) düğmesine basın



# NASIL KULLANILIR

## 1. Açma

2 saniye boyunca basın  
LED, ürünün açık  
olduğunu gösterir.

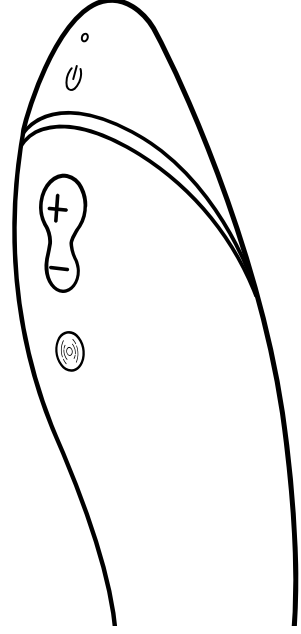

## 2. Kullanım

Havaya girmek için  
önce klitorisinizde  
**OG** kullanın.

**OG**'nin içine su bazlı  
kayganlaştırıcı ekleyin.

Isındıktan sonra **OG**'yi  
yerleştirin ve G noktanızı keşfedin!

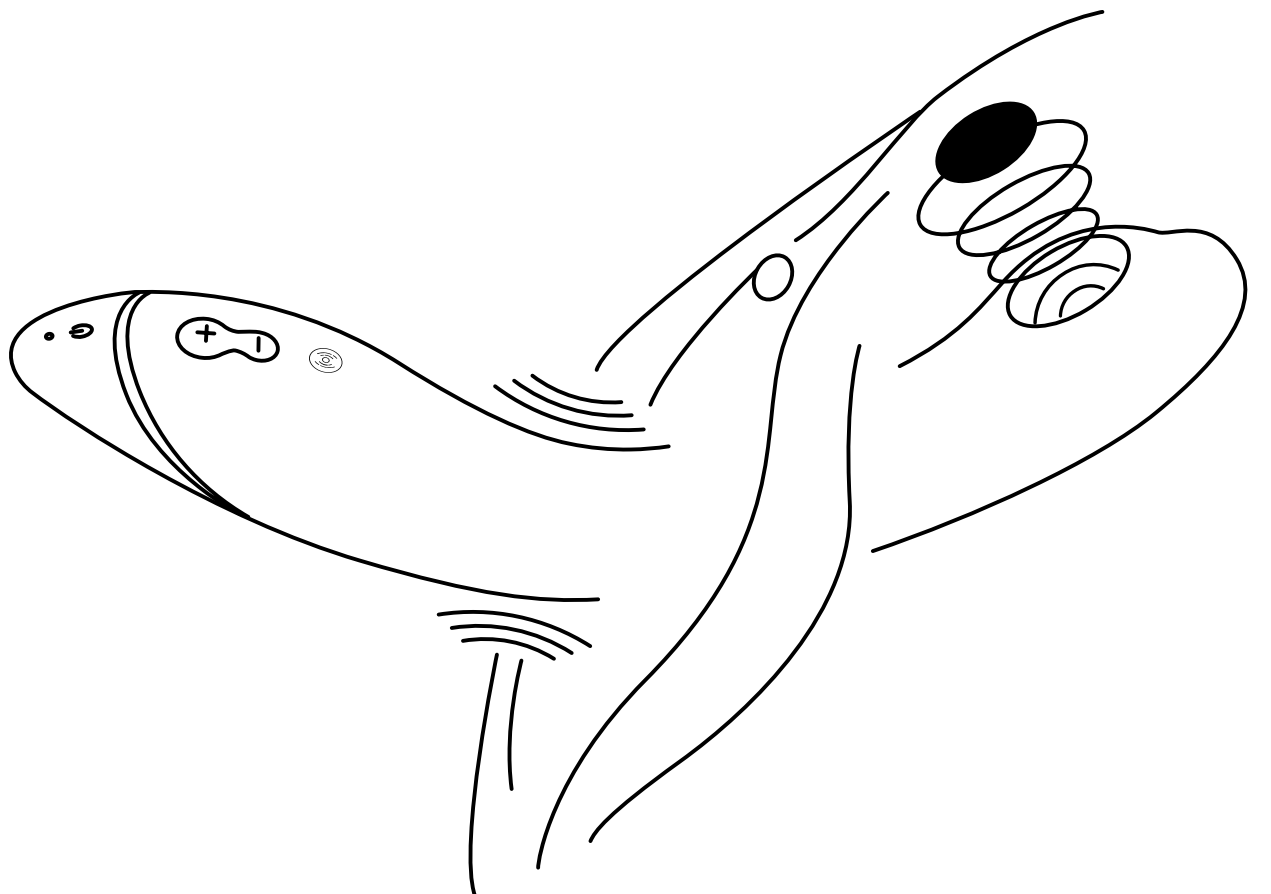
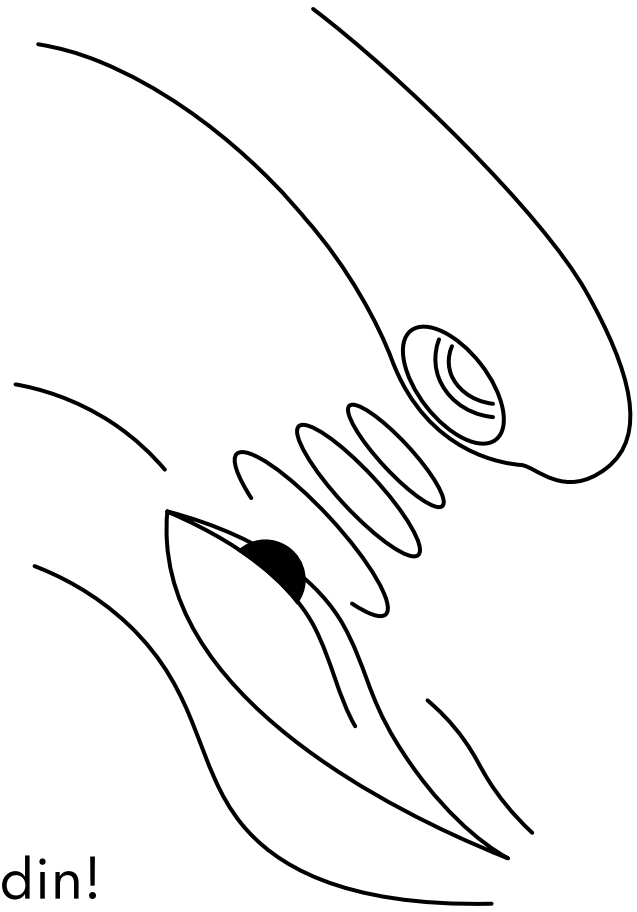

# NASIL KULLANILIR

## 3. Yoğunluęu Deęiřtirme

### Artırma

Kısa süre basın

### 12 Yoęunluk Seviyesi

### Artırma

Kısa süre basın

### 3 Titreřim Seviyesi

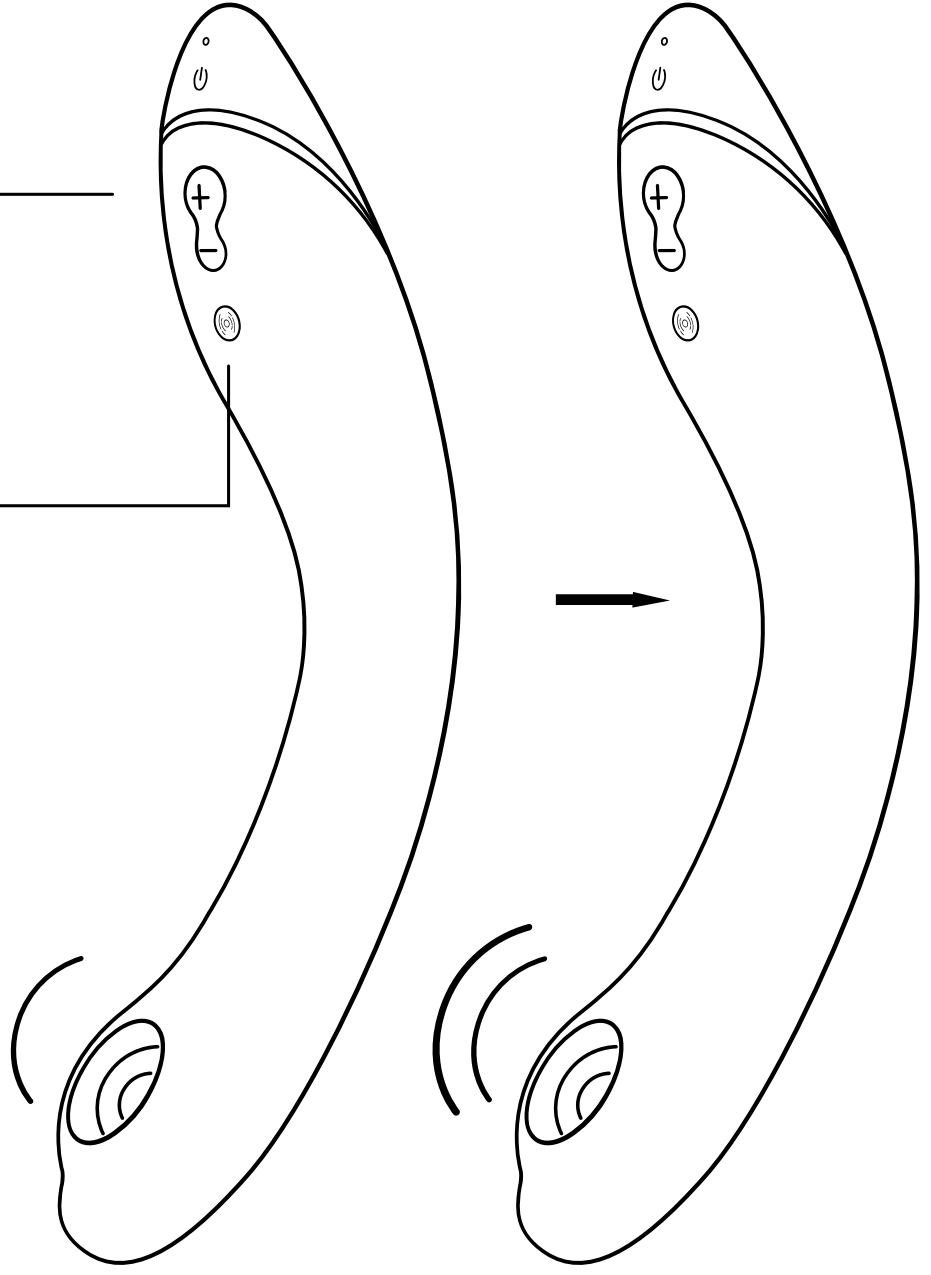

### Azaltma

Kısa süre basın

### Hoř bir deneyim sonrası bir süre daha hissedilen haz Yoęunluk Seviyesi 1'e geri d6nmek ięin 1 saniye boyunca (-) d6ęmesine basın

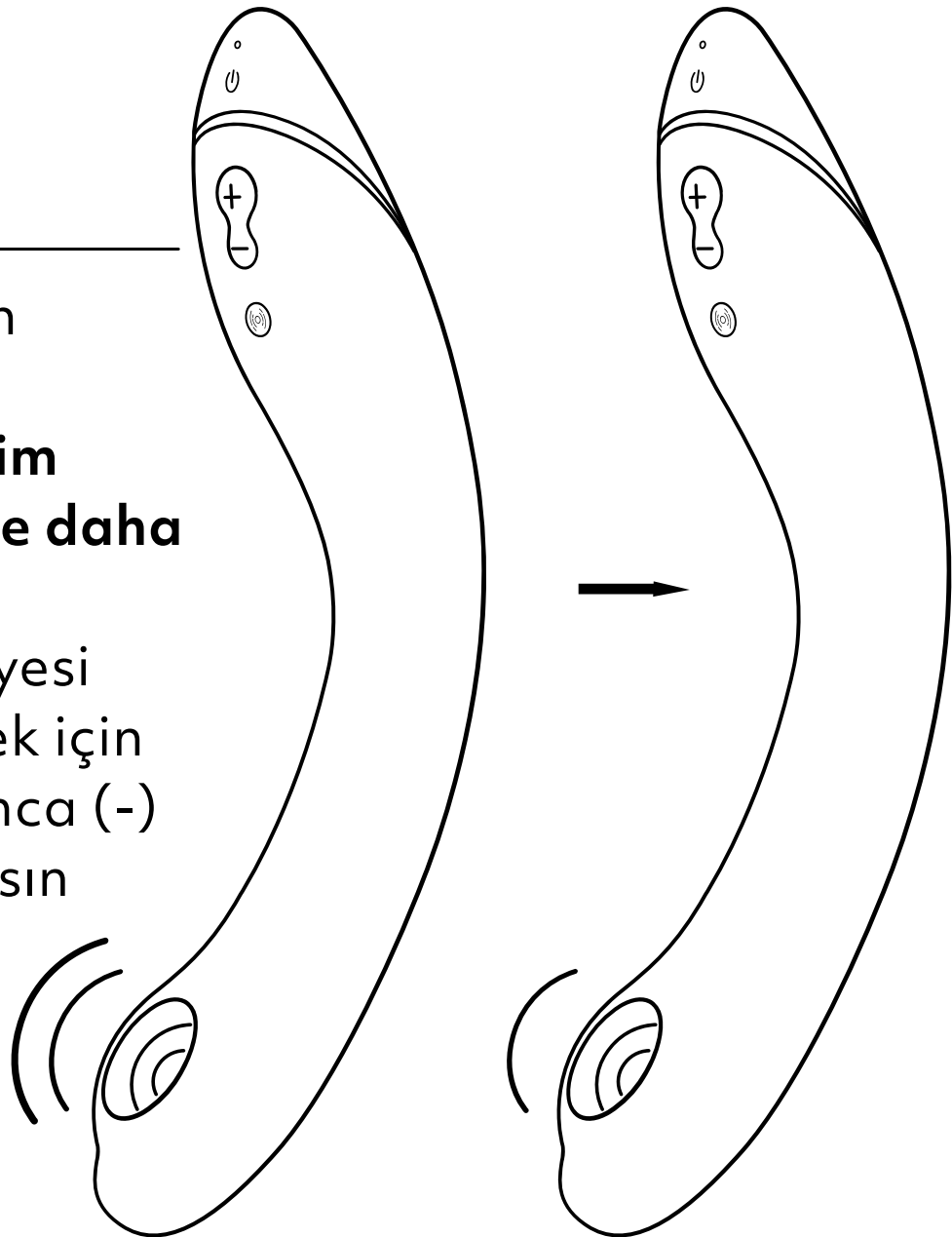

# NASIL KULLANILIR

## 4. Kapama

2 saniye boyunca basın

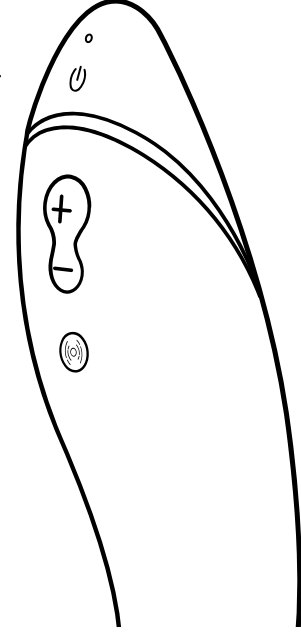

## AKILLI SESSİZLİK

**OG** yalnızca cildinize neredeyse temas ettiğinde açılır. Akıllı Sessizlik varsayılan olarak açıktır. Akıllı Sessizlik özelliğini açmak veya kapatmak için artı ve eksi düğmelerini 2 saniye basılı tutun.”

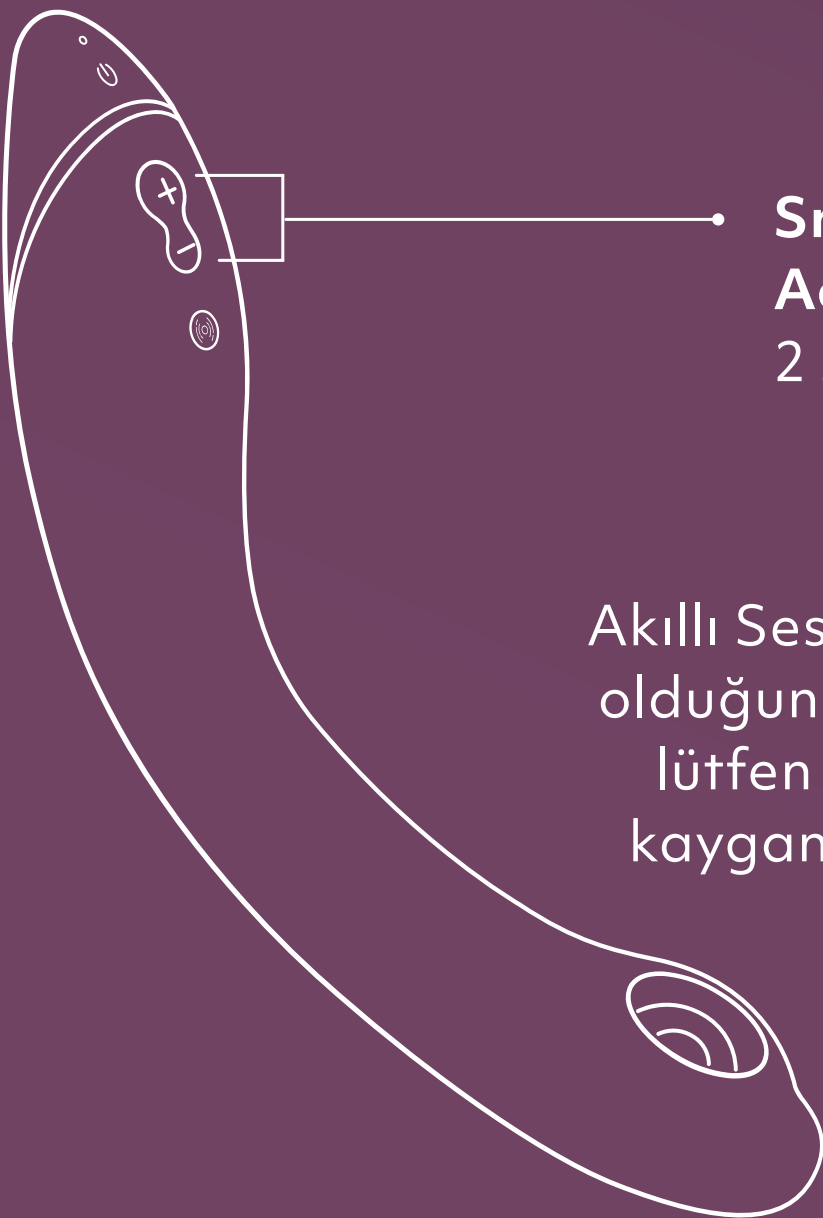

**Smart Silence**

**Açık/Kapalı**

2 saniye boyunca basın

Akıllı Sessizlik, stimülasyon başlığı ıslak olduğunda çalışmayabilir. Bu nedenle, lütfen Zevk Havası başlığının içine kayganlaştırıcı uygulamadığınızdan emin olun.

# TEMİZLEME

Suyun altında yıkayın.

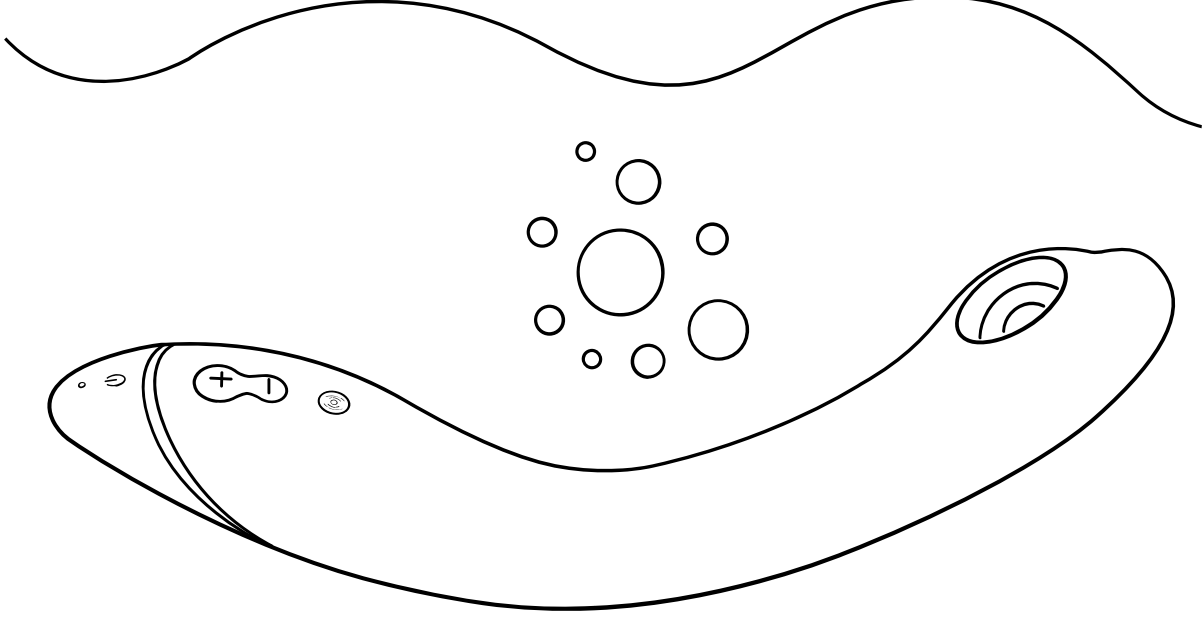

Oyuncak temizleyicisi kullanın.

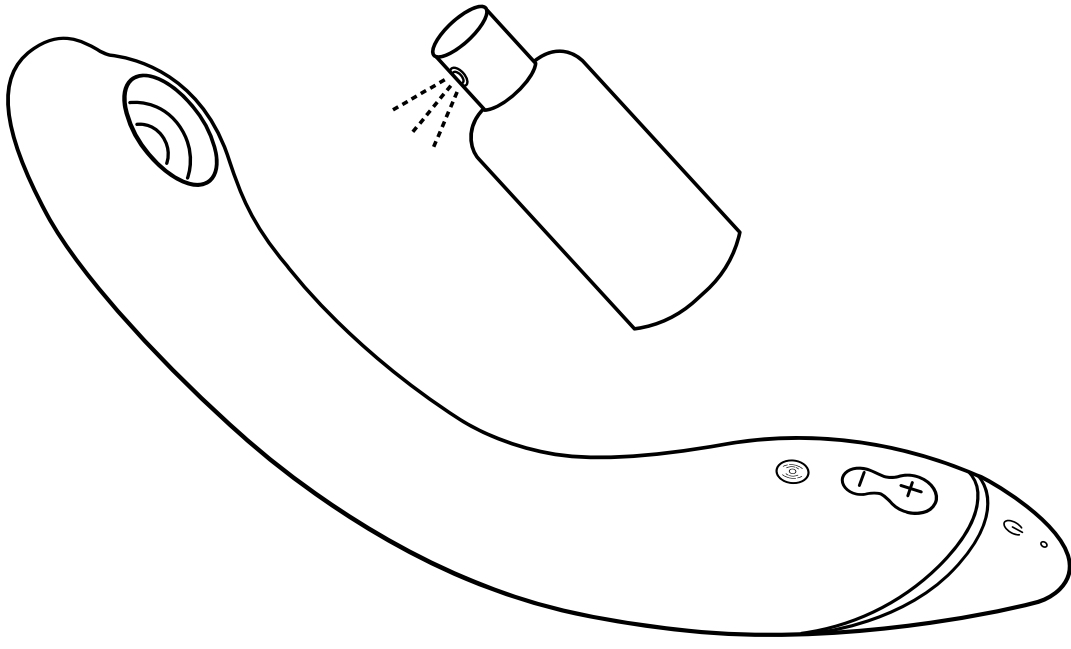

Membrana çok fazla baskı uygulamadan dikkatlice kurulayın.

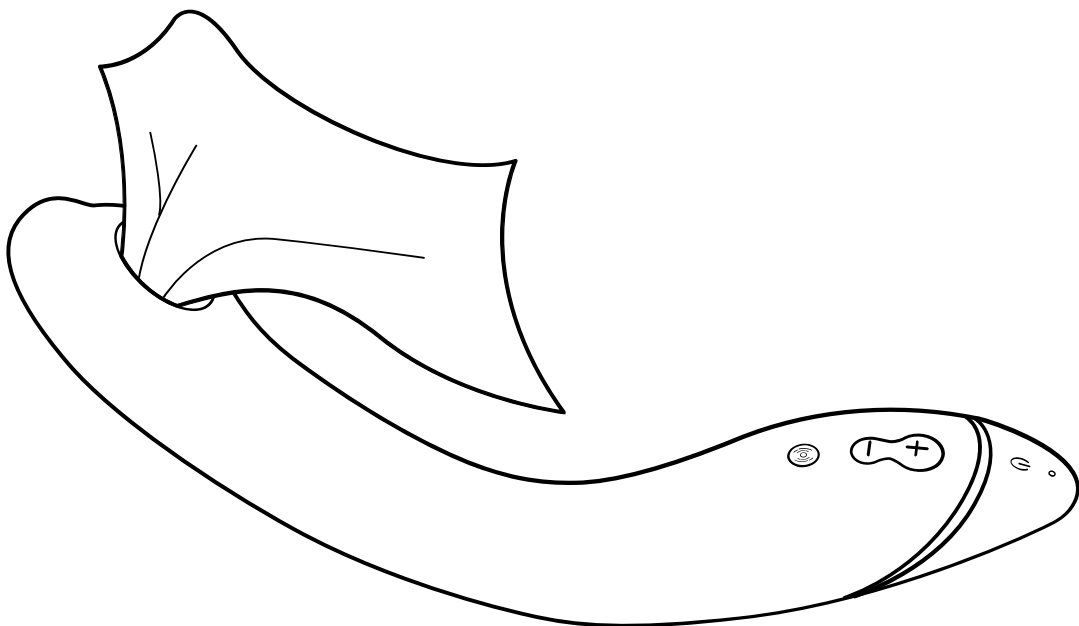

Suya dayanıklı  
(IPX7)



# ŞARJ

Lütfen ilk kullanımdan önce **OG'nizi** şarj edin.  
Ayrıca, uzun pil ömrü sağlamak için **OG'nizi** düzenli olarak şarj etmeyi unutmayın.

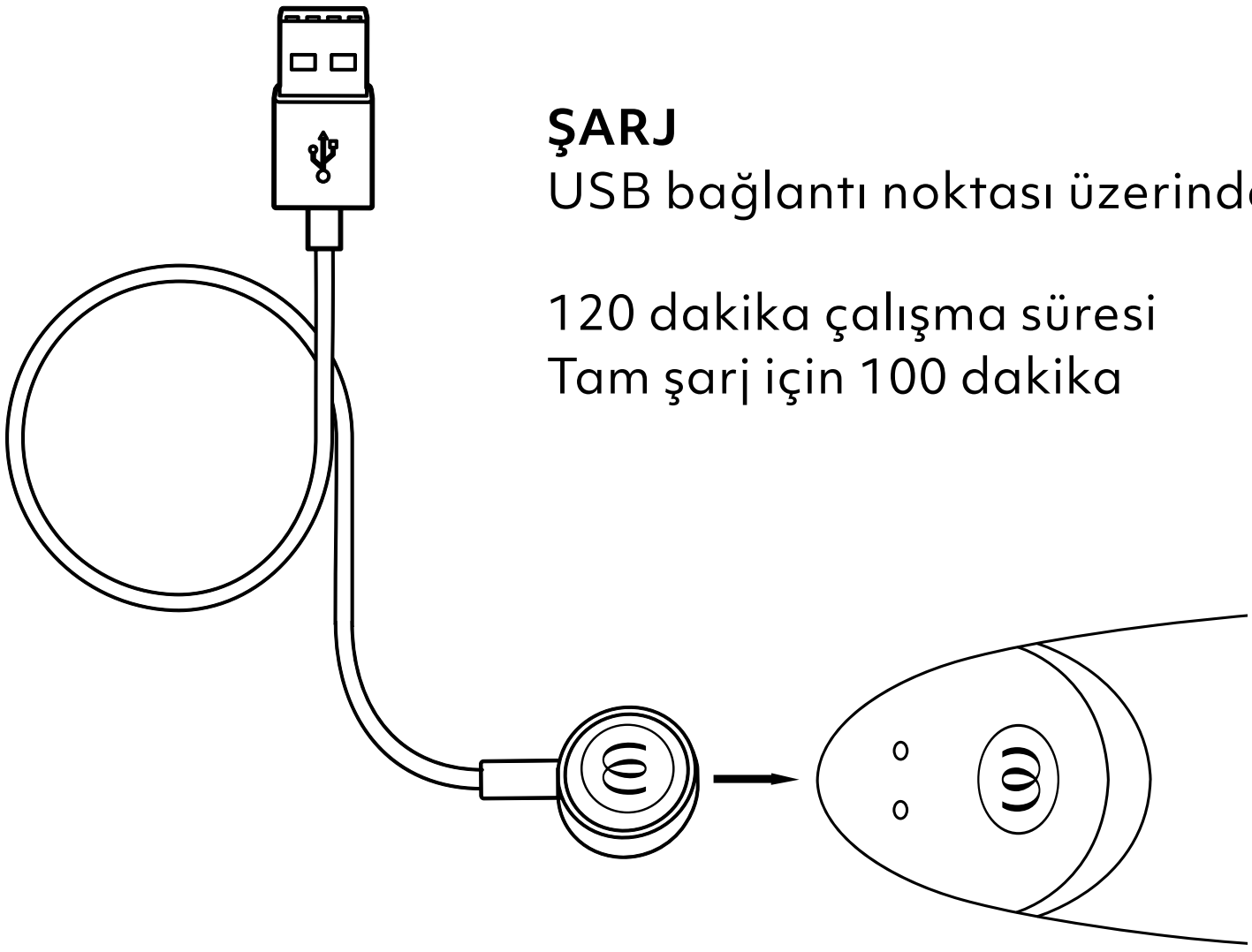

## ŞARJ

USB bağlantı noktası üzerinden

120 dakika çalışma süresi

Tam şarj için 100 dakika

## LED

Açık/Kapalı/Şarj oluyor

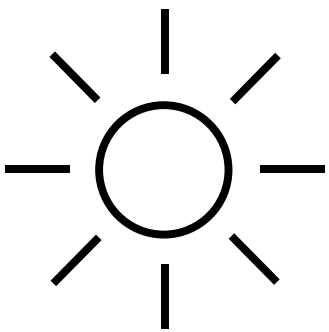

**Tamamen dolu**  
LED sürekli yanıyor

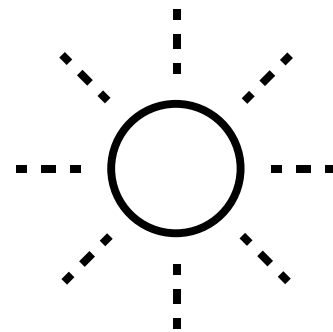

**ŞARJ**  
LED yanıp sönüyor

# SAFETY INSTRUCTIONS

## UYARI

Yalnızca yeni, birinci el ürün olarak satılabilir. Ürünü yalnızca öngörülen kullanım amacı doğrultusunda kullanın. Bu ürünü çocuklardan uzak tutun. Tıbbi amaçlı kullanıma uygun değildir. Sağlığınızla ilgili doktor kontrolü altında olmanızı ve/veya bir tıbbi cihaz kullanmanızı gerektiren bir durum söz konusuysa, ürünü kullanmadan önce lütfen doktorunuza danışın. Ciltte herhangi bir tahriş, ağrı veya rahatsızlık hissi oluşması durumunda ürünü kullanmayı derhal bırakın ve doktorunuza başvurun.

Bu cihaz yalnızca yetişkinler tarafından ve de -gözetim altında tutulmaları veya cihazın güvenli kullanımına ilişkin ilgili talimatları almış ve buna bağlı tehlikeleri de idrak etmiş olmaları kaydıyla- fiziksel, duyuşal veya zihinsel kabiliyetleri kısıtlı ya da yeterli deneyime ve bilgiye sahip olmayan kişiler tarafından kullanılabilir. Ürün, çocukların oynaması için uygun değildir. Temizleme ve bakım işlemleri çocuklar tarafından yapılmamalıdır. Ürün, şişmiş veya iltihaplı cilt üzerinde kullanılmamalıdır.

- Ürün kullanılmadan önce genital bölgedeki tüm piercingler ve takılar çıkarılmalıdır.
- Ürünü her kullanım öncesinde ve kullandıktan sonra, kullanım kılavuzundaki talimatlara uyarak, temizleyin.
- Ürünün hasar görmesini önlemek için, ürünü ve pili 45 °C'nin üzerindeki sıcaklıklara maruz bırakmayın, parçalarına sökmeyin ve mekanik hasarlara veya elektrik hasarlarına yol açmayın.
- Seks oyuncaklarının paylaşılması cinsel hastalıkların bulaşmasına neden olabilir. Seks oyuncaklarınızı partnerinizden başka kimseyle paylaşmayın. Gereken durumlarda partnerinizle birlikte koruyucu önlemler alın. Ürünün kaplama malzemesinde herhangi bir çatlak veya bozulma fark etmeniz halinde ürünü kullanmayın.
- Bu ürün, anal kullanım için tasarlanmamıştır. Anal kullanıma uygun değildir. Anal olarak kullanmayın!
- Leke oluşumlarının önlenmesi için, ürününüzün yumuşak tarafını emici yüzeylerin üzerine bırakmayın.
- Ürünün şarj cihazını ve ürünün kendisini düzenli olarak hasar yönünden kontrol edin ve bileşenlerinin herhangi birisinin hasarlı olması durumunda ürünü kullanmayın.
- Manyetik alanlar mekanik ve elektronik aksamaların (örn. kalp pilleri) üzerinde istenmeyen etki oluşturabilir. Ürünü doğrudan kalp pilinin üzerine gelecek şekilde kullanmayın. Daha fazla bilgi için doktorunuza başvurun. Mıknatıs parçaları içeren ürünler cihaza zarar verebileceğinden, manyetik şeritli kartları (örn. kredi kartları) cihazdan uzak tutun.
- Ürününüzün çalışma şeklinde bir anormallik fark etmeniz halinde cihazı kapatın ve web sitemizdeki destek bölümüne başvurun.

## ŞARJ ETME

- Yerel şebeke gerilimi, şarj cihazı üzerinde belirtilen maksimum giriş geriliminin üzerinde olmamalıdır. Bu nedenle şarj cihazını ilk kez kullanmadan önce gerilimin bulunduğunuz yerin gerilim seviyesiyle uyumlu olduğundan lütfen emin olun.
- Ürün yalnızca cihaz üzerindeki güç etiketine uygun olan çok düşük güvenlik gerilimi ile beslenmelidir.
- Pil şarj olurken ürünü kullanmayın veya temizlemeyin.
- Şarj cihazını veya şarj kablosunu asla suya veya başka sıvılara batırmayın.
- Bu ürün, değiştirilemez piller içerir.
- Bu ürün, şarj edilebilir bir Li-ion pil içerir.
- Her şarj sonrasında şarj kablosunu elektrik kaynağından çıkarın.

## ÜRÜNÜN EN İYİ ŞEKİLDE KULLANILMASINI SAĞLAMAK İÇİN, LÜTFEN AŞAĞIDAKİ TALİMATLARA UYUN:

- Uzun pil ömrünün temin edilebilmesi için, cihazı -kullanılmadığında bile- lütfen düzenli şarj edin.
- Doğrudan gün ışığı almayacak şekilde, güvenli ve kuru bir yerde saklayın.
- Bu ürünün su bazlı bir kayganlaştırıcı ile birlikte kullanılmasını tavsiye ediyoruz. Ürünün hasar görmesini önlemek için parfümlü, silikon bazlı veya alkol bazlı kayganlaştırıcılar, jeller ya da masaj yağları kullanmayın.

# GENERAL INFORMATION

## ELECTRICAL RATING

**Model:** OG

**Model No.:** TES10A

**Power Input:**

3,7 V=0,62 A: Built-in Li-Polymer rechargeable battery.

5 V=0,5 A: When charged using USB.

Use USB AC adaptor (not included) with power output corresponding to product rating. Use original provided cable only."

## CONTENT OF DELIVERY

Womanizer OG G-Spot vibrator, USB charging cable (AC adapter not included), cotton storage pouch, quick start guide, safety instructions

## ENVIRONMENTAL PROTECTION

As a distributor of electronic devices, we are legally obliged to accept the return of waste electrical and electronic devices free of charge. We expressly state that you as the user are legally obliged to return used batteries.

Never throw away electronic devices or batteries in the household waste. The symbol shown below (crossed-out wheeled bin) is intended to expressly remind you of this.

## MANUFACTURED AND DISTRIBUTED BY

**WOW Tech Europe GmbH**

Hermann-Blankenstein-Strasse 5

10249 Berlin

[www.wowtech.com](http://www.wowtech.com)

WOW Tech Europe GmbH reserves the right to make technical changes and changes to the design that serve to improve the device.

For information regarding patents see [womanizer.com/patents](http://womanizer.com/patents).

## CUSTOMER CARE

[care@womanizer.com](mailto:care@womanizer.com)

[womanizer.com](http://womanizer.com)

Designed in Germany. Made in China.

Date of issue: 10/2022.



# STILL WANT MORE?

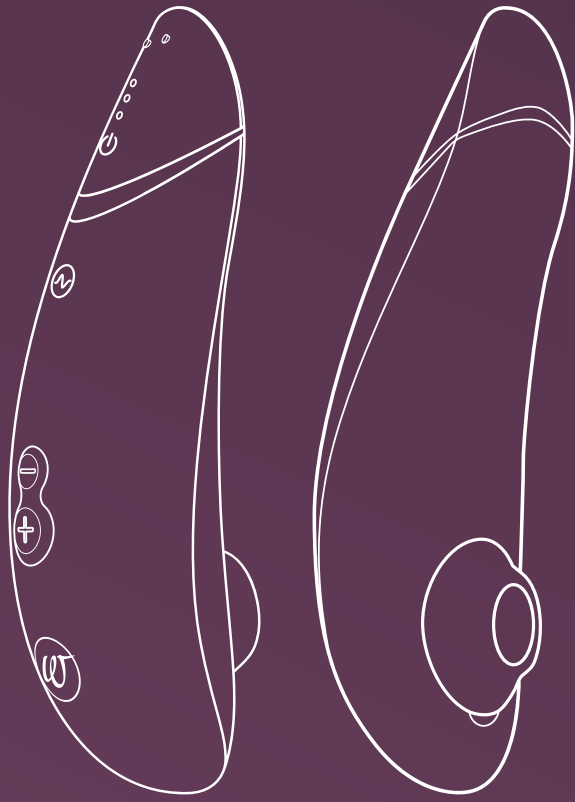

Pleasure Air  
Technology

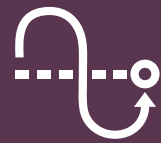

Autopilot



Smart Silence

**Premium 2**  
Define your luxury

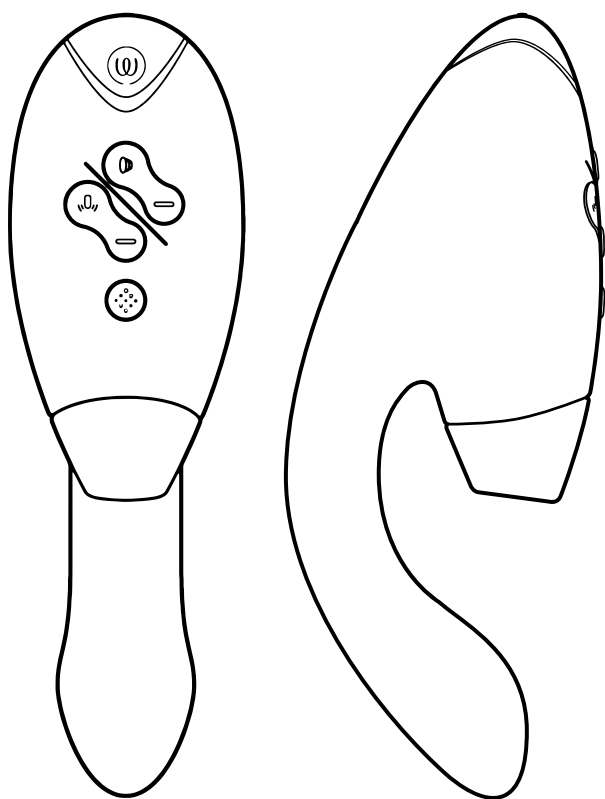

Pleasure Air  
Technology



Double Stimulation

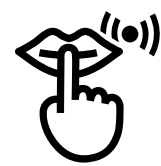

Smart Silence

**DUO 2**  
Indulge in whole-body orgasms



#IMASTURBATE